



DESIGN HIGHLIGHTS

- Quiet smooth three motor system.
- Space efficient design.
- Unique functionality.
- Wide range of cabinetry and wall design options.

OPTIONS

- Marine suitable.
- Horizontal versions.
- Horizontal single panel systems.
- Vertical single panel systems.
- Larger screen options.
- Combination with the QA articulated arm.

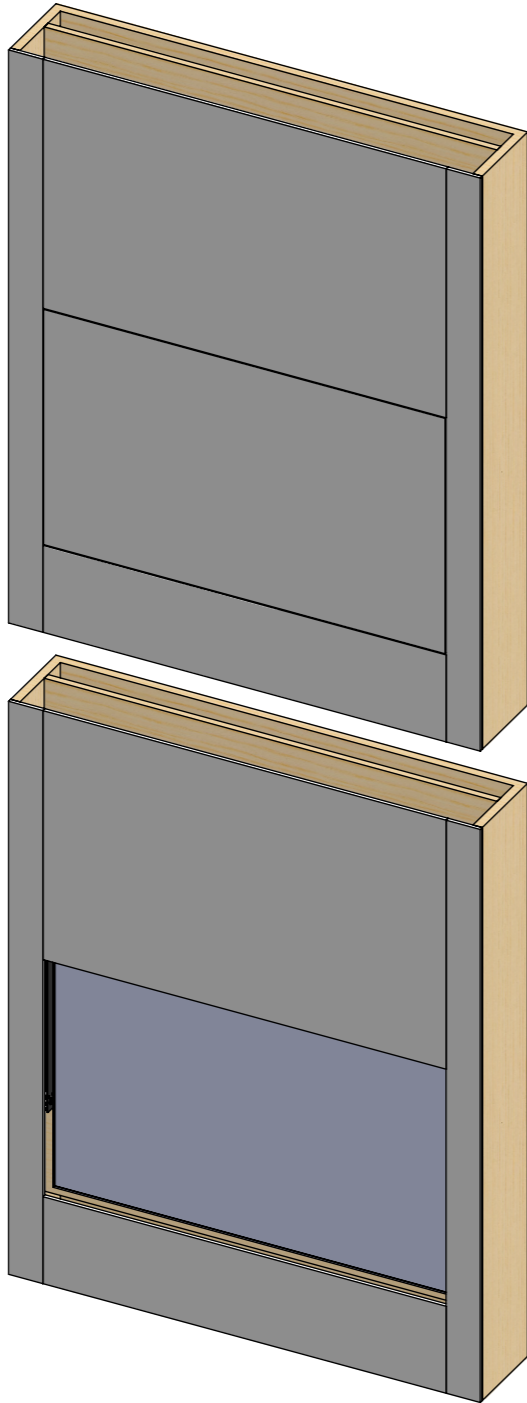

A panel the same size as the screen fills the opening.

Panel drops back

Panel lifts up/drops down to reveal TV in recess

Screen is then advanced to fill the opening.

Panel Drive Included

Panel Mechanism SPS1300 Included

Screen Advance Heavy SAH Included

Panel Mechanism SPS1300 Included

Just mechanism as supplied. Four separate mechanisms make up the kit.

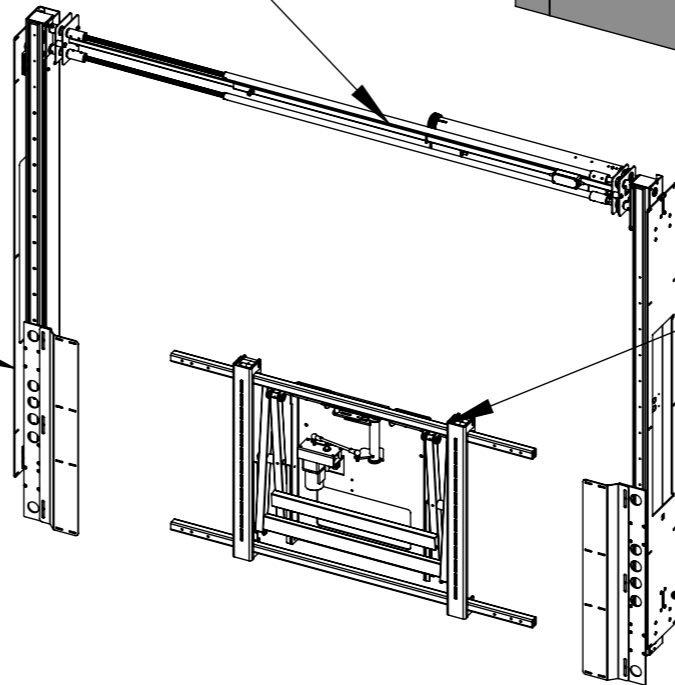

FUNCTION

This mechanism splits and retracts two panels inwards and out of site behind surrounding panel work before advancing the screen to sit flush with the wall.

SUITABILITY

The SPS 1300 is typically suitable for screens from 80" to 98".

Minimum Screen size is (h) 750mm [29.5] x (w) 1610mm [63.4]

Maximum Screen size is (h) 1270mm [50.0] x (w) 2100mm [82.7]

Maximum Screen weight is 100kg [220lbs]

Please note the panel weight restriction is 30Kg [66.6lbs] on all models.

SPECIFYING

The mechanism requires the screen to be recessed into the wall or purpose designed cabinet work.

CONTROL

Supplied with basic infrared remote. Can be learnt by many learning remotes.

Also has switch control and RS232 so can be operated by relays, switches, Crestron / AMX or Lutron systems.

The **Panel Mechanisms** and the **Panel Drive** are all telescopic to efficiently accommodate different screen sizes.

WARNING

It is the responsibility of the installer to warn all potential end users of the dangers of interfering with mechanisms during operation

IMPORTANT

Mechanisms which lift or move weights need to be checked on a yearly basis for any damage which may result in an accident



SPS1300

IMPORTANT NOTES

- The depth of 230mm [9.1"] will allow a **maximum screen depth of 40mm [1.6"]**.
- For screens **thicker than 40mm [1.6"]** the **cavity depth must be increased**. I.e screen depth of 100mm [3.9"] - cavity depth required is 290mm [11.4"]
- Thinner screens do not allow the cavity to reduce in depth. 230mm [9.1"] is the minimum.

CABINET PANEL THICKNESS

- The moving panel retracts back by 40mm [1.6"] before splitting. For this reason it is advised the **front panel work is only 20mm [0.8"] thick** to give 20mm [0.8"] clearance.
- Thicker panels will add to cabinet depth.
- The front panels must be removable to make installation possible

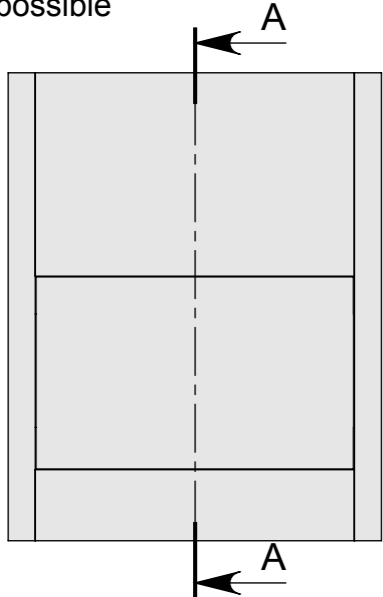

Screen - IN

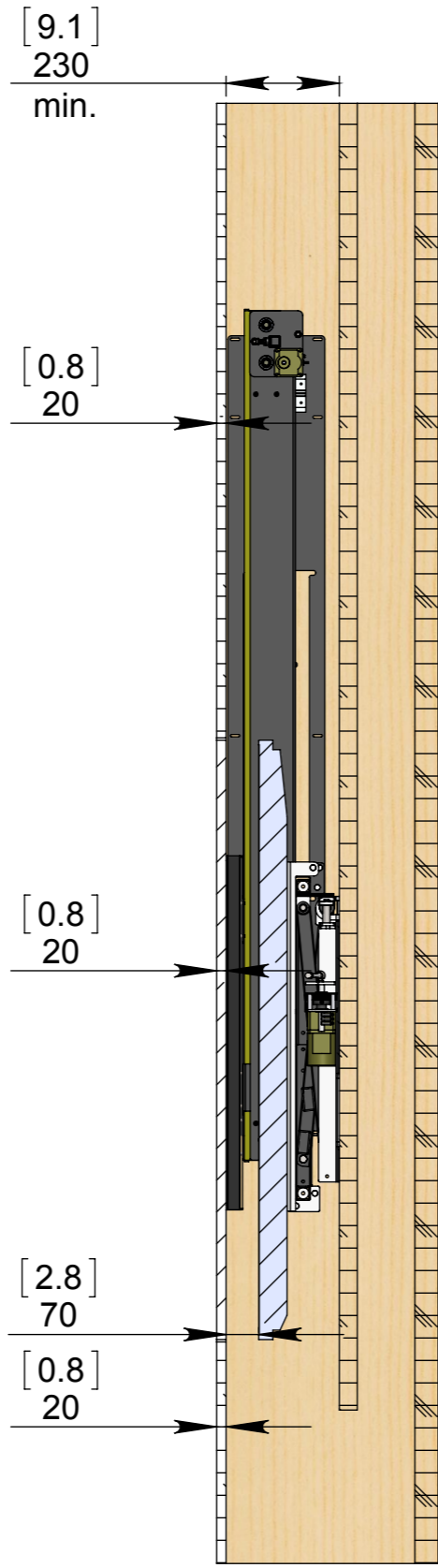

SECTION A-A
SCALE 1 : 15

Screen - OUT

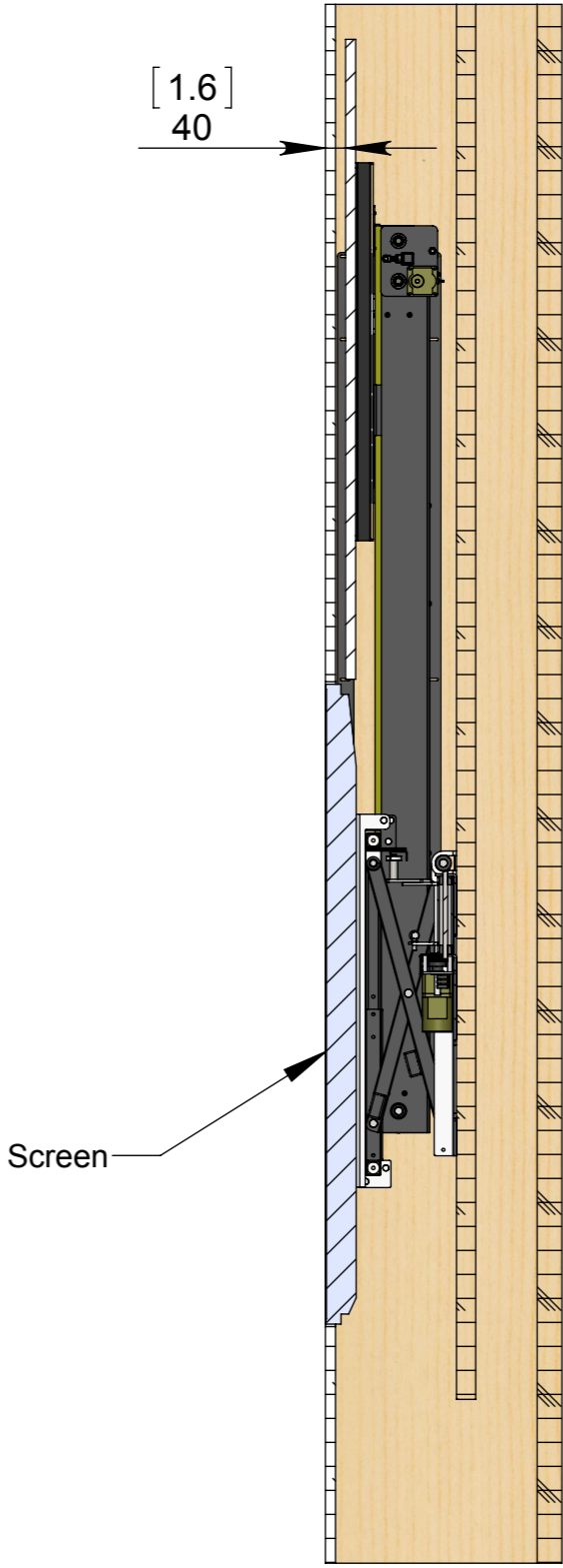

SECTION B-B
SCALE 1 : 15

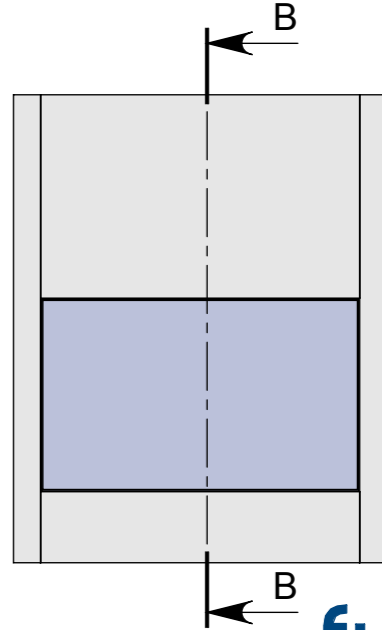
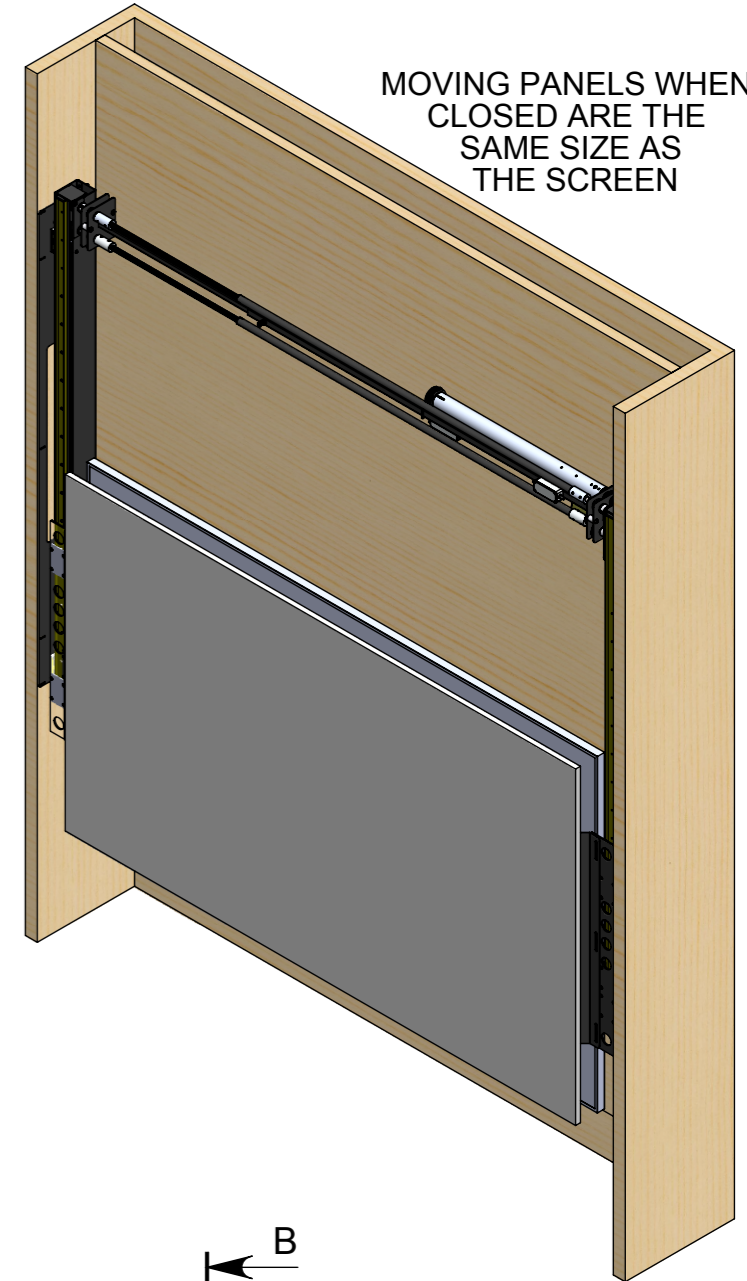

SPS1300

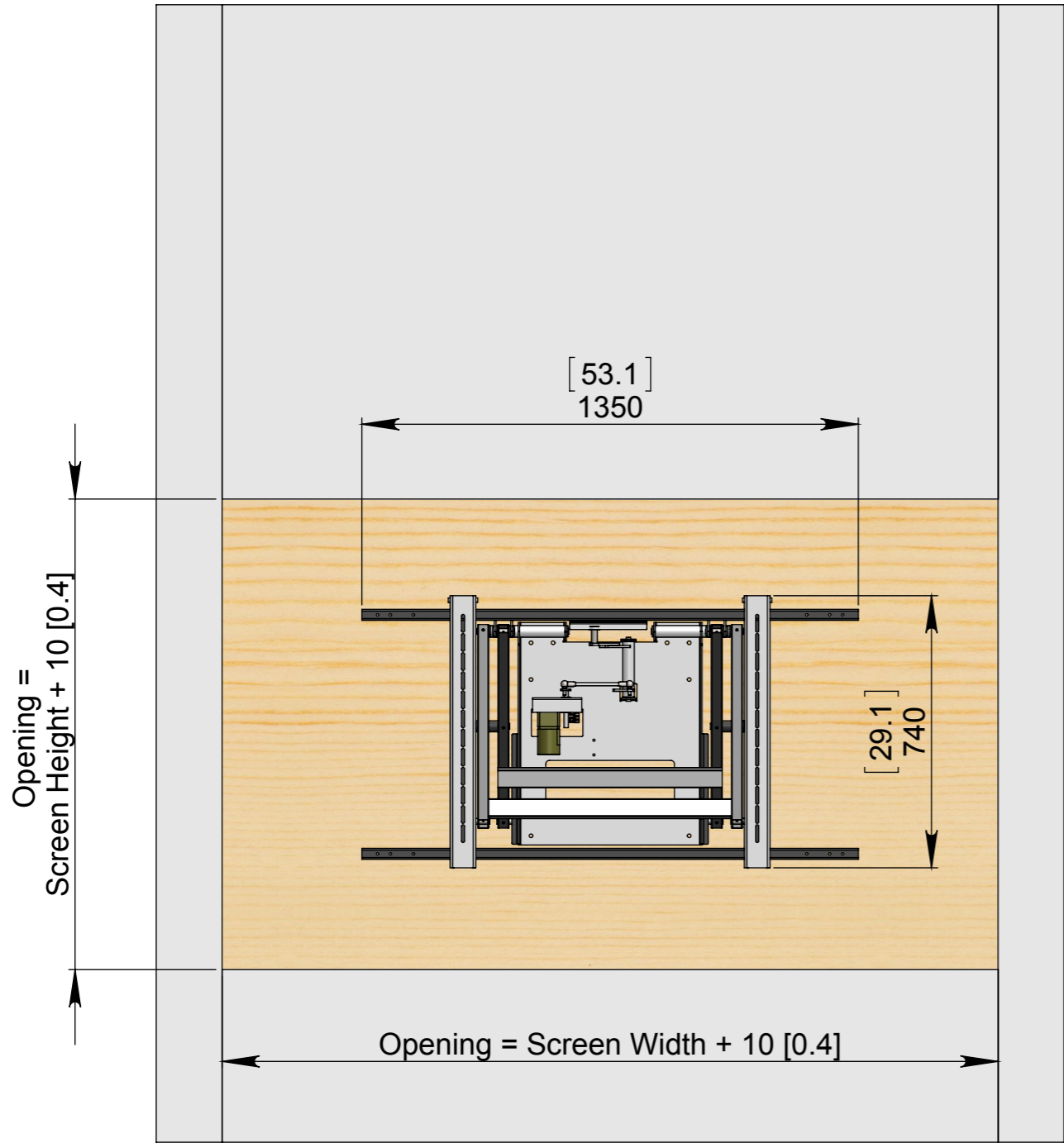
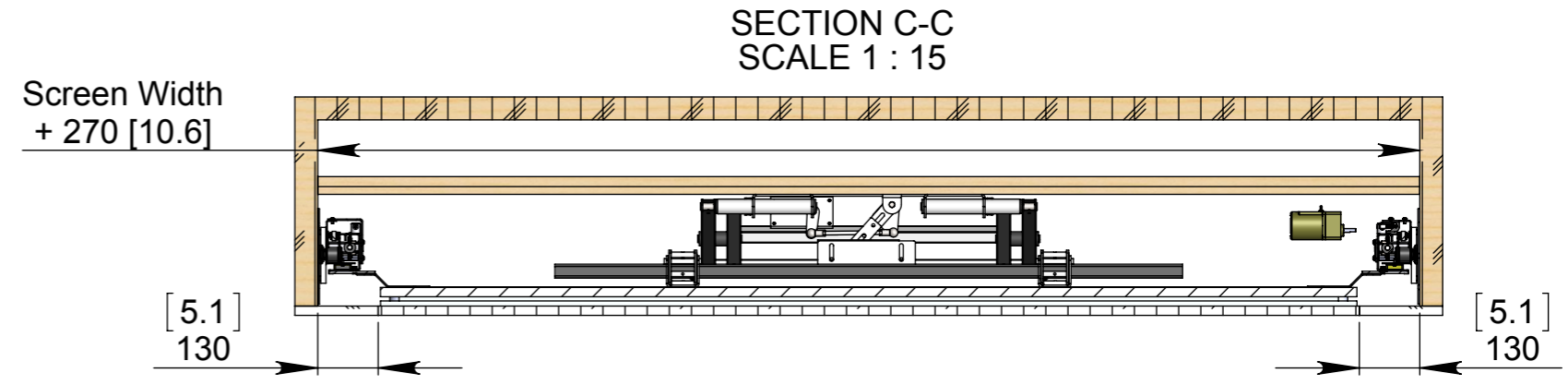
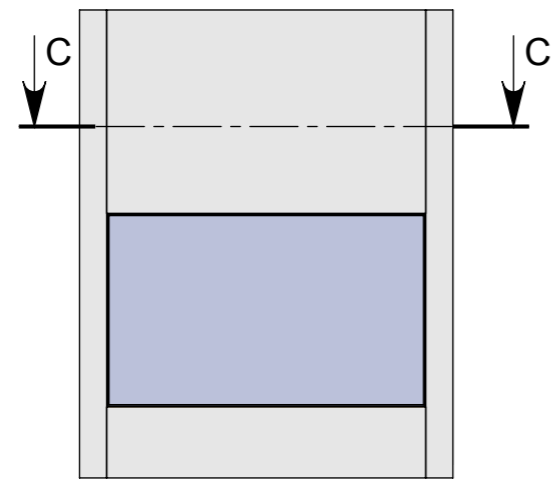

The Screen Advance Heavy bracket can accommodate a screen bolt pattern up to: VESA 800 x 600. Up to M8 diameter fixings.

The bracket can be positioned within the opening as required based on TV VESA mount location.

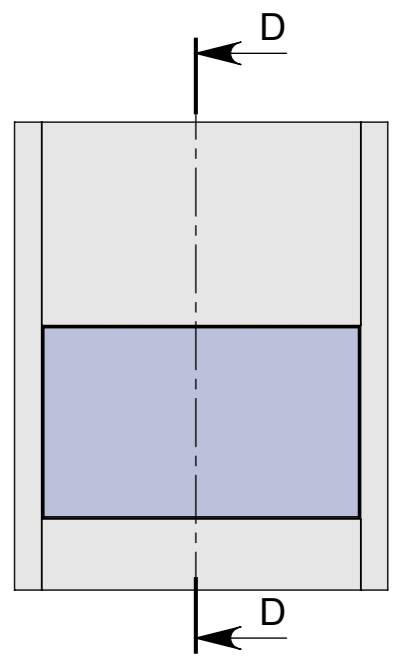
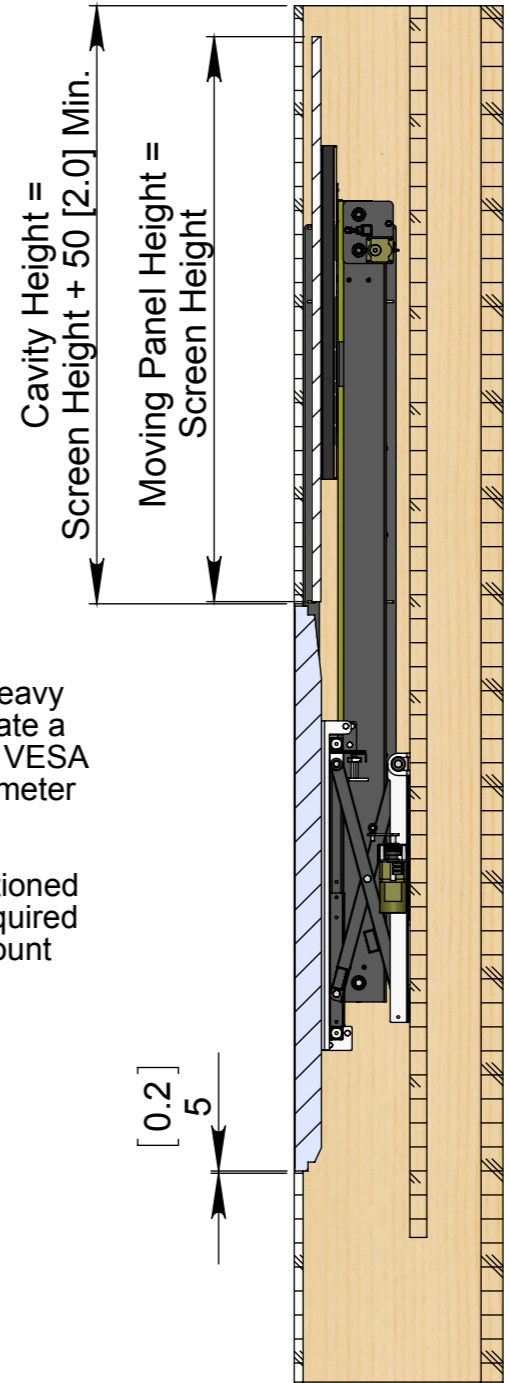

SECTION D-D
SCALE 1 : 17

SAH - Screen Advance Heavy

ADVANCE BRACKET IN

ADVANCE BRACKET OUT

ADVANCE BRACKET SERVICE MODE

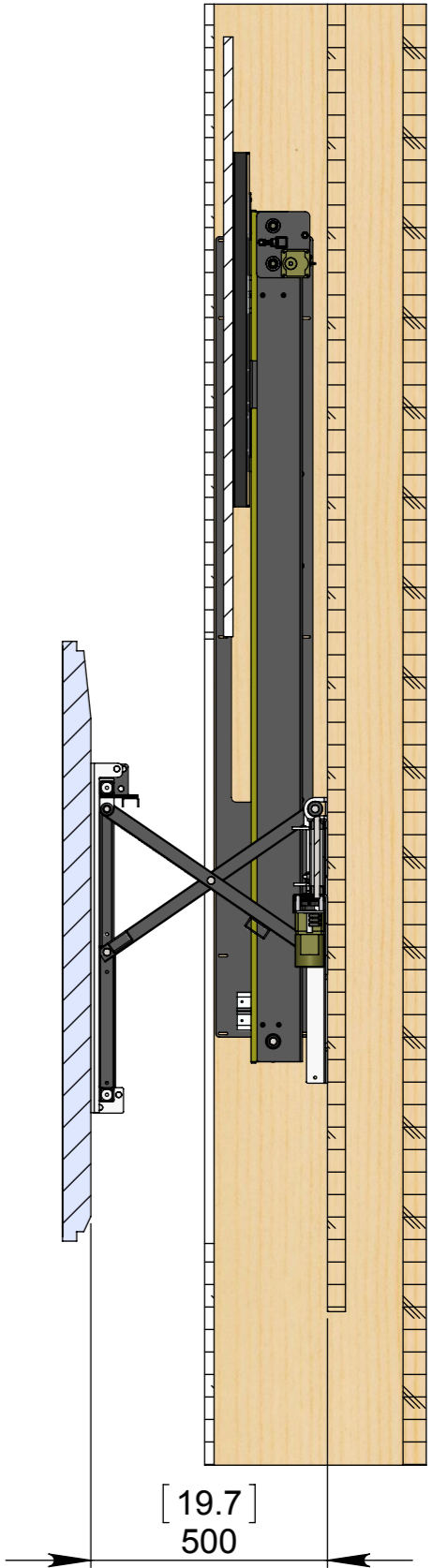
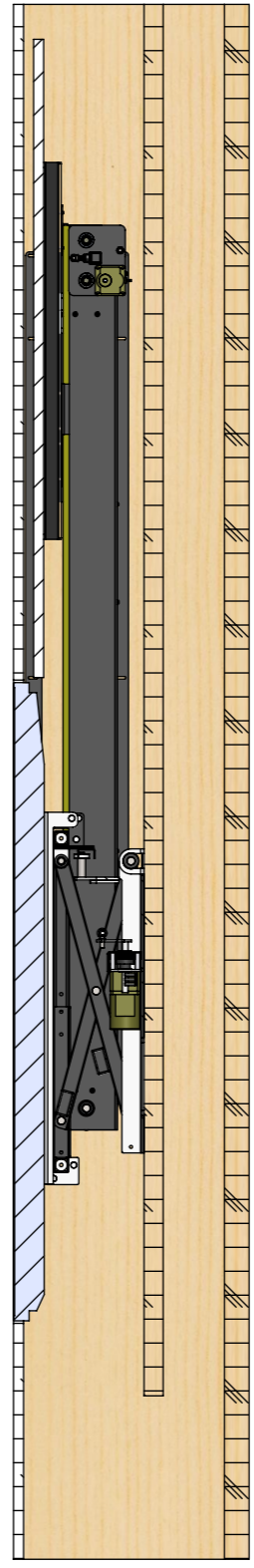
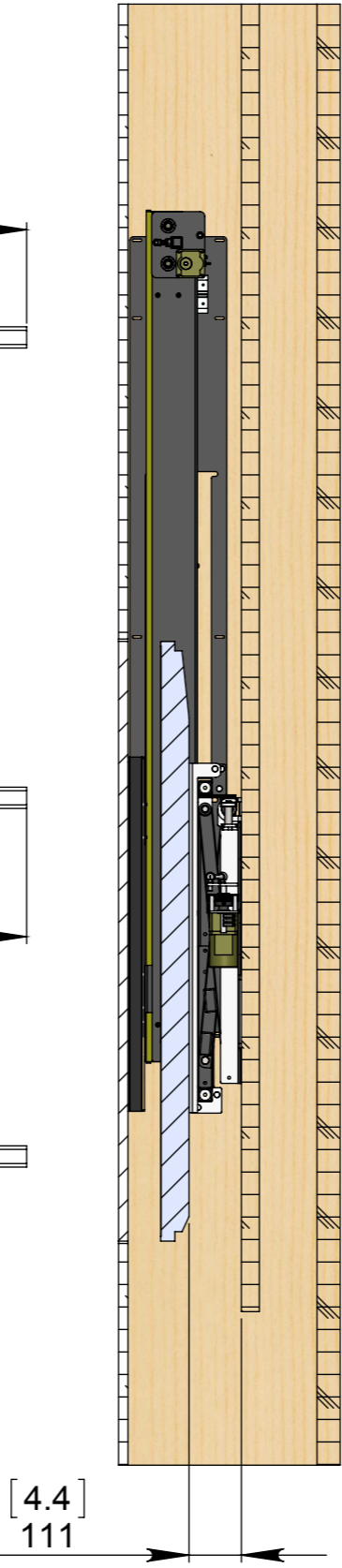
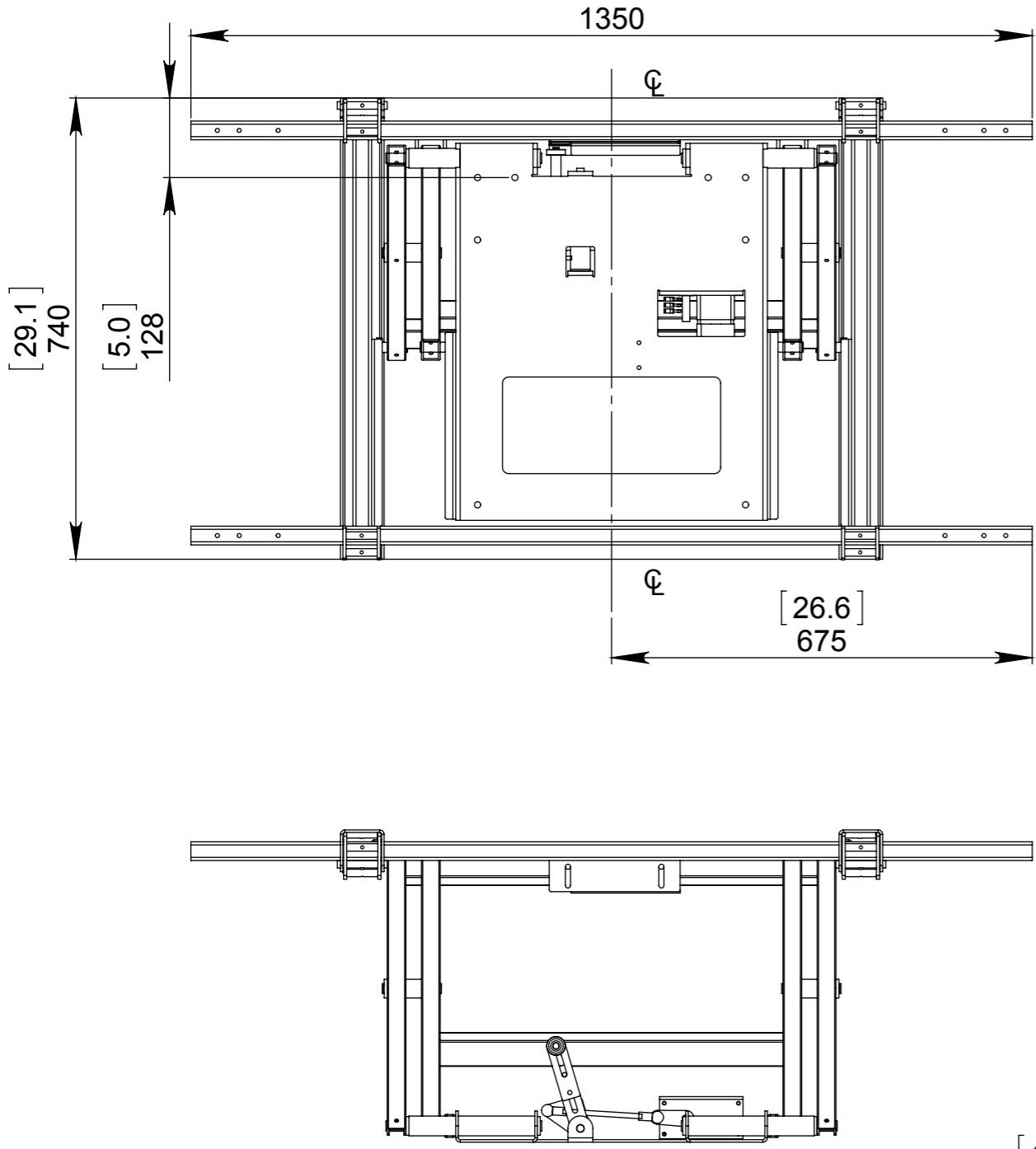

The Screen Advance Heavy bracket has a service mode that can be used during installation and servicing of mechanisms and TV. This allows TV to be pulled out far from the wall to allow access to back of the screen and inside the mechanisms during fitting.

SPS Essential Access

- The SPS mechanism requires some thought to the cabinet design to make sure the mechanism elements are all easily accessible for fixing in place and for making adjustments. Poorly designed cabinets will result in a lot of wasted time during installation and setting up.
- Poor access can result in compromises being made on panel alignment and effect the quality of the installation.
- There are many styles of panel work that lend themselves to this mechanism, but ultimately all surrounding front panel work should be removable to aid in fitting of the different mechanism elements. (1)
- Image 2 shows the best system, where different panels are removable to get access at different stages of the installation and set up.
- In image 3 the side panels are removed to get access to install the Panel Drive part of this mechanism.
- (4) With the side panels in place, good access is still possible to the Moving panel mounting plates with the top and bottom panels removed. These access panels enable the main moving panel to be finely adjusted.
- A control box is supplied on a 3m [10'] flying lead. This must be fitted in an easily accessible location. This will be the first item to be checked if the mechanism stops working. Infrared, contact closure and power connections are all made here.

