

**LOEWE.**



# Loewe **stellar**

de	Bedienungsanleitung	5
en	User Manual	29
nl	Gebruiksaanwijzing	53
fr	Manuel de l'utilisateur	77
it	Manuale utente	101
es	Manual de uso	125
pt	Manual do Utilizador	149







# Loewe stellar. Made in Germany.

## Willkommen.

Herzlichen Dank, dass Sie sich für Loewe stellar entschieden haben. Wir freuen uns, Sie als Loewe Kunden begrüßen zu dürfen. Mit Ihrem Kauf sind Sie nun im Besitz eines Premium Fernsehers, der Design, Innovation und neueste Technik vereint. Das OLED-TV-Modell Loewe stellar besticht durch modernste Displaytechnologie, leistungsstarke Hardware und eine neue Designsprache.

Loewe stellar wird in Deutschland gefertigt.

Jedes Detail dieses Produktes spiegelt die Hingabe und das handwerkliche Geschick wider, das Loewe und seine Mitarbeiter seit über 100 Jahren auszeichnet. Das einzigartige Lichtkonzept macht Loewe stellar zu etwas Besonderem. Genießen Sie Ihren Magic Moment mit dieser außergewöhnlichen Produktlinie. Loewe Dual-Channel dr+ mit Triple-Tuner eröffnet Ihnen zudem neue Dimensionen des Fernsehens – genießen Sie Multi-View und Multi-Aufnahme in perfekter Qualität.

Für Gaming-Enthusiasten bietet stellar, mit vollständiger Unterstützung von 4x HDMI 2.1 und Ultra HD @ 144 Hz VRR, ein nahtloses und Hochgeschwindigkeits-Gaming-Erlebnis. Unsere umfassende Palette an Streaming-Apps und VoD-Diensten, powered by Premium Tizen OS, garantiert Unterhaltung für jeden Geschmack.

Lesen Sie diese Anleitung bitte sorgfältig durch. Damit Sie lange und sicher Freude an Ihrem Loewe Produkt haben, beachten Sie bitte die separat beiliegenden Sicherheitshinweise. Sollten Sie Fragen haben oder Hilfe benötigen, steht Ihnen das Loewe Customer Care Center jederzeit zur Verfügung.



In dieser Bedienungsanleitung finden Sie wichtige Basisinformationen zur Erstinstallation Ihres Loewe TVs. Nach dem ersten Einschalten leitet Sie eine intuitive Benutzerführung durch die Erstreinrichtung des Fernsehers. Ein detailliertes eManual, das die Funktionen und Eigenschaften Ihres neuen Loewe TVs umfassend beschreibt ist in Ihren TV integriert und auf der Loewe Website zu finden.



[www.loewe.tv](http://www.loewe.tv)

## Inhaltsverzeichnis

Willkommen.	5
Symbole und Typenschild.	6
Lieferumfang.	7
Überblick - TV.	8
Erste Schritte - TV Installation.	10
Überblick - Fernbedienung.	12
Erste Schritte - Fernbedienung.	14
Erste Schritte - TV Inbetriebnahme.	16
Erste Schritte - TV Inbetriebnahme.	18
Startbildschirm.	20
Elektronischer Programm-Guide.	21
Multi-Aufnahme.	22
Loewe magic.light	24
Loewe magic.motion	25
Apps und Technische Informationen.	26
Herstellereklärung.	27
Impressum.	27



Bedeutung von Hinweisen.

# Symbole und Typenschild.

Diese Anleitung enthält zahlreiche Symbole. Auf dieser Seite erfahren Sie die Bedeutung dieser Symbole. Lesen Sie sich diesen Abschnitt genau durch und beachten Sie die Bedeutung.

Auf dem Typenschild finden Sie wichtige Geräteinformationen:

- Geräte name
- Gerätetyp
- Artikel
- Seriennummer



Warnhinweise machen auf Gefahren aufmerksam, die Ihre Gesundheit oder Ihr Leben bzw. die Gesundheit oder das Leben anderer Personen gefährden können. Beachten Sie die Warnhinweise.



Umwelthinweise enthalten Informationen zu umweltbewusstem Handeln oder umweltbewusster Entsorgung. Beachten Sie die Umwelthinweise.



Allgemeine Hinweise und Tipps im Umfang mit der Gerät oder einer Anwendung des Gerätes.



Elektrohinweise machen auf Gefahren aufmerksam, die bei Nichtbeachtung Ihre Gesundheit oder Ihr Leben bzw. das elektronische Gerät in seiner Funktion beschädigen könnten.



Bruchgefahrhinweise weisen darauf hin, dass die Gefahr besteht, Ihr Gerät zu beschädigen oder dass Verletzungen möglich sind. Beachten Sie die Bruchgefahrhinweise.

Position des Typenschildes.

Den Aufkleber mit der Modellnummer und der Betriebsspannung finden Sie auf der Rückseite des Fernsehgeräts.

Beispiel Typenschild:

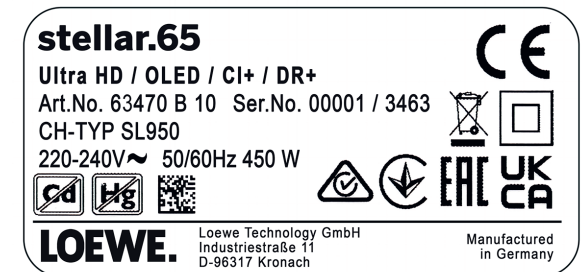

# Alles was Sie brauchen. **Lieferumfang.**

Vergewissern Sie sich, dass der Inhalt der Verpackung und der Loewe welcome box vollständig ist. Falls etwas fehlen sollte, setzen Sie sich bitte mit Ihrem Händler oder dem Loewe Customer Care Center in Verbindung.

Inhalt der Verpackung.

- Loewe quick start guide
- Betriebsanleitung (dieses Dokument)
- Loewe stellar
- Aufstelllösung
- Netzkabel
  
- Loewe welcome box
  - Loewe remote stellar
  - Loewe remote stellar mini
  - Batterien Typ AAA
  - Technische Datentabelle stellar
  - Loewe OLED Sicherheitshinweise
  - Montageanleitung für die Aufstelllösung
  - Montageset für die Aufstelllösung

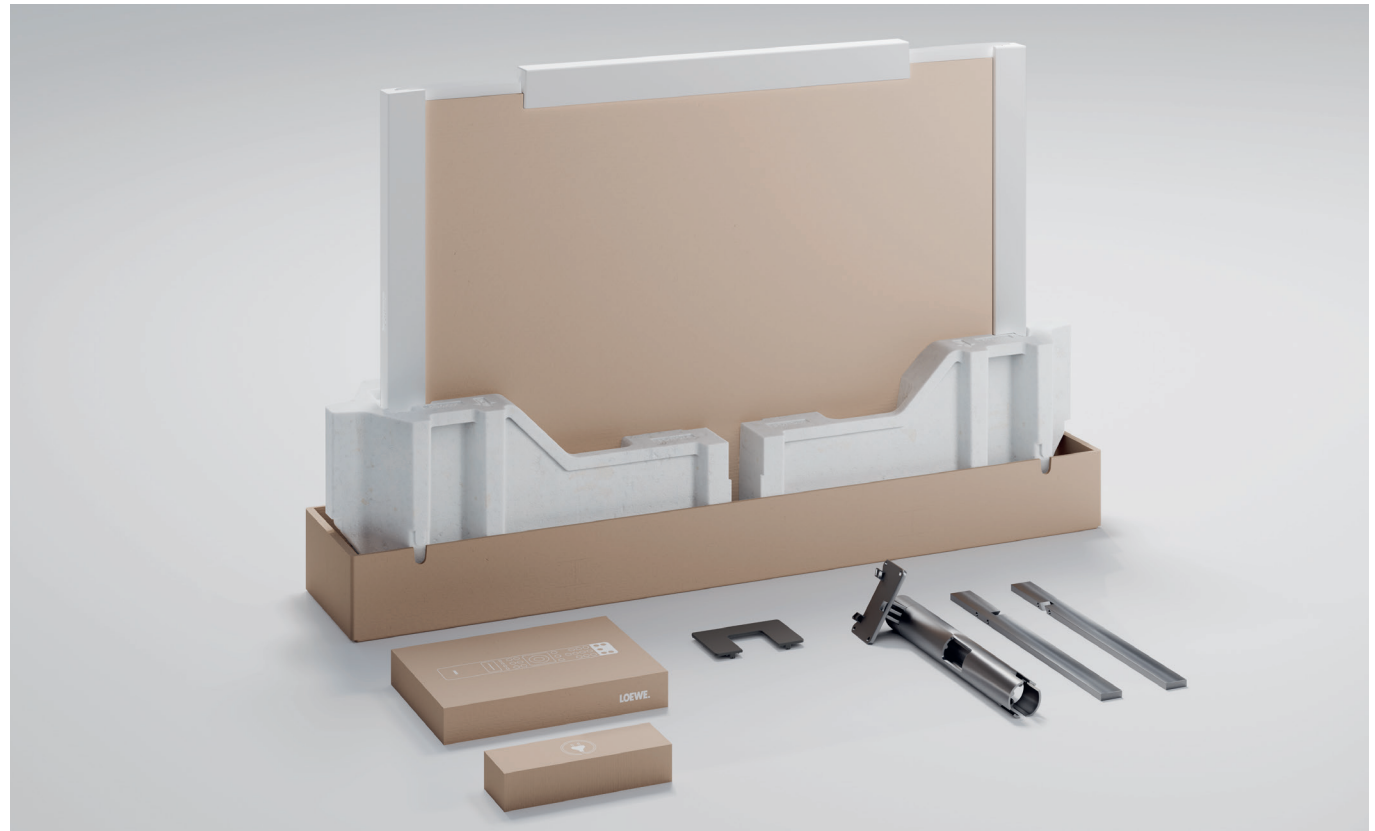

Vorderseite.

# Überblick - TV.



① Loewe signature.ring

LED-Farbe TV-Status

- Standby
- TV ein: Panel an
- TV ein: Panel aus
- TV Standby: OLED-Refresh
- Aufnahme aktiv
- Timeshift aktiv

② Loewe table stand stellar \*

③ Loewe magic.light

④ Soundbar

⑤ OLED Bildschirm

⑥ Loewe signature.flag

\*Abhängig von Variante und Größe.



# Rückseite.



①	AC-IN	Netzanschluss - 220-240 V - 50/60Hz
②	LAN*	Netzwerk-Verbindung RJ-45
③	HDMI 1	HDMI 2.1 mit eARC Audio-OUT
④	HDMI 2	HDMI 2.1 Eingang
⑤	HDMI 3	HDMI 2.1 Eingang
⑥	USB-A	USB 2.0 - 5V $\overline{=}$ , 2000 mA max.
⑥	USB-A	USB 2.0 - 5V $\overline{=}$ , 2000 mA max.
⑦	USB-C	USB 3.1 - 5V $\overline{=}$ , 1000 mA max.
⑧	ANT SAT	Satellitenbuchse - DVB-S/S2 HD
	SUB	13/18V, 400mA
⑨	ANT SAT	Satelliten-Antenne DVB-S/S2 HD
	MAIN	13/18V, 400mA
⑩	ANT TV	Kabel/TV-Antenne DVB-C/T/T2 HD
⑪	Common Interface	CI+ V1.4
⑫	HDMI 4	HDMI 2.1 Eingang
⑬	Audio Out Toslink	Audio-Ausgang Klinke 3.5mm/ TOSLINK
⑭	USB-A	USB 2.0 - 5V $\overline{=}$ , 2000mA max.
⑮	USB-C	USB 3.1 - 5V $\overline{=}$ , 1000 mA max.

\*Die Verwendung eines Cat5-LAN-Kabels ohne Abschirmung wird empfohlen.

Auspacken und anschließen.

# Erste Schritte - TV Installation.



## 1. TV auspacken.

Falls Sie den TV noch nicht ausgepackt haben, folgen Sie den einfachen Schritten im Loewe quick start guide. Gehen Sie zu Schritt 2 dieser Anleitung über, wenn Sie den TV an der Aufstelllösung sicher befestigt haben.



Beachten Sie die Sicherheitshinweise und die technischen Daten.



Diese Informationen sind für eine sichere Installation und Betrieb des TVs erforderlich.



## 2. Anschluss der Antennenkabel.

Schließen Sie nun das Sat- bzw. Antennenkabel an. Die beschrifteten Anschlüsse befinden sich auf der Rückseite des TVs. Um die Anschlüsse freizulegen, entfernen Sie vorsichtig die Abdeckungen. Diese sind leicht zu lösen. Es sind keine Werkzeuge erforderlich.



Die Kabel erst am TV anschließen, dann an der Satellitenanlage oder dem Kabelanschluss. Nutzen Sie das Kabelmanagement am TV und der Loewe-Aufstelllösung.

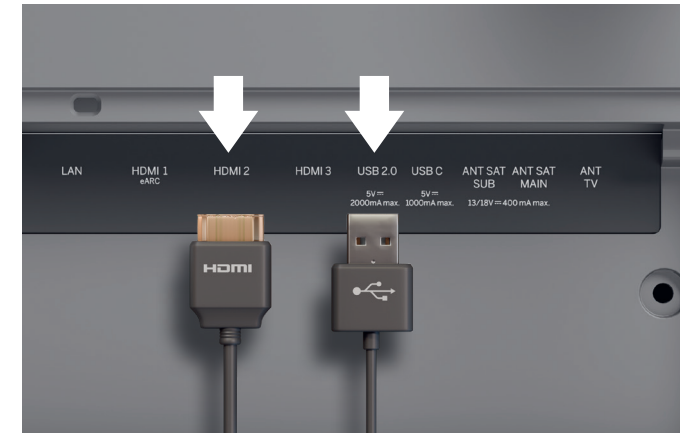

## 3. Zusatzgeräte anschließen.

Es können via HDMI und USB zusätzliche Geräte, wie Spielekonsolen oder Speichermedien angeschlossen werden. Details dazu finden Sie im eManual in den Hilfe-seiten in Ihrem TV und der Loewe Homepage.



Trennen Sie alle Geräte vor dem Anschließen vom Stromnetz.



#### 4. Netzwerk via LAN.

Sie können den TV mit einem LAN verbinden. Die Verbindung mit einem WLAN erfolgt im folgenden Abschnitt „Erste Schritte - TV-Inbetriebnahme“.

**i** Verwenden Sie für den Anschluss an das LAN ein RJ45 CAT7-Kabel (10/100 Mbit/s).



#### 5. Audio via HDMI eARC.

Sie können eine Loewe Klangbar oder Ihre Soundanlage über ein HDMI-Kabel mit dem Fernseher verbinden. Verwenden Sie dafür den HDMI 1-Anschluss, der HDMI 2.1 mit eARC-Audio-OUT unterstützt.

**i** Für höchste Videoauflösung und eARC nutzen Sie ein HDMI „Ultra-High-Speed“ Kabel, Typ-A-Stecker. (nicht im Lieferumfang enthalten)

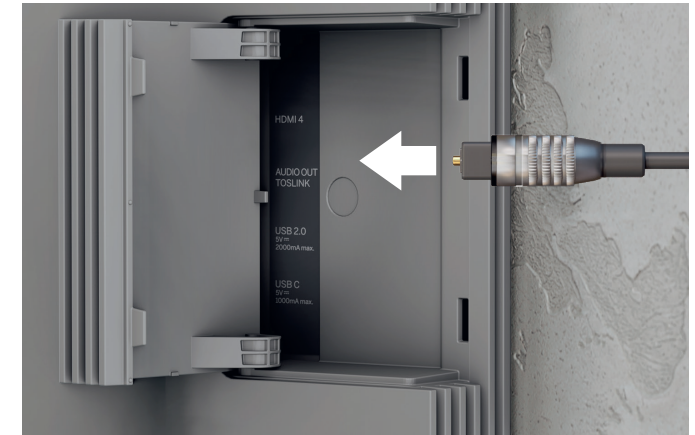

#### 6. Audio: Mini-TOSLINK/Analog.

Sie können ein Audiosystem via TOSLINK anschließen. Die Anschlussart hängt von Ihrem Audiosystem ab. Verbinden Sie den TV-Ausgang „AUDIO OUT TOSLINK“ mit dem Audiosystem.

Digital: Nutzen Sie ein optisches Kabel Mini-TOSLINK zu TOSLINK

Analog: Nutzen Sie ein Stereo-Cinch/Klinken-Adapterkabel für die Verbindung zwischen TV und Audioanlage.



Zwei für Eins.

# Überblick - Fernbedienung.

## Loewe **remote stellar**



Zusätzliche Funktionen  
Loewe magic.light  
Loewe magic.motion













	Ein/Aus	TV-Gerät ein- oder ausschalten.
	Mute	Ton ein- oder ausschalten.
	TV-Modus	Kurz: Live-TV, Lang: Bedienung auf TV-Gerät 1 wechseln.
	Eingang	Kurz: Geräteauswahl öffnen, Lang: Bedienung auf Gerät 2 umstellen.
	Aufnahme	Kurz: Aufnahme starten, Lang: Bedienung auf Gerät 3 umstellen.
	Programm	Programmdirektwahl durch Drücken der Nummerntaste.
	123-Funktion	Live-TV: Aufnahme-Menü, Programm-Manager, Aufnahme, Timeshift.
	Guide	Kurz: TV-Programm (EPG) aufrufen, Lang: Senderliste aufrufen.
	Einstellungen	Kurz: Menü „Einstellungen“ öffnen, Lang: Menü „Alle Einstellungen“ öffnen.
	Richtung	Fokus/Menüwerte ändern. Drücken Sie je nach Auswahl nach links/rechts oder hoch/runter.
	Auswahl	Auswahl oder Starten eines markierten Elements. Live-TV: Anzeigen der Details zur aktuellen Sendung.
	Lautstärke	Lautstärke erhöhen/verringern.
	Programm	Nächster oder vorheriger Sender.
	Zurück	Kurz: Zurück zum letzten Menüpunkt/Live-TV: letzter Sender, Lang: Schließen des Menüs.
	Startbildschirm	Startbildschirm öffnen.
	Play/Pause	Medien wiedergeben/anhalten oder Timeshift (zeitversetztes Fernsehen) starten/pausieren/fortsetzen.
	magic.light	Aktiviert Einstellungen für magic.light, siehe Kapitel „Loewe magic.light“.
	Teletext	Teletext/MediaText ein/aus.
	magic.motion	Aktiviert die Motorsteuerung des magic.motion*, siehe Kapitel „Loewe magic.motion“.
	Funktion	Menüabhängige Funktionstasten.
	Apps	Direktasten zum Starten von Apps und Video-On-Demand Diensten.

\*optional

## Loewe **remote stellar mini**



 Zusätzliche Funktion  
Audio-Sprachbefehle

	Ein/Aus	TV-Gerät ein- oder ausschalten.
	123-Funktion	Eingabe von Ziffern und Farbtasten Live-TV: Menü zu Aufnahmen, Programm-Manager, Aufnahme, Timeshift
	Mikrofon	Drücken Sie die Mikrofontaste für Sprachbefehlsteuerung.
	Einstellungen	Kurz: Menü „Einstellungen“ öffnen.
	Richtung	Fokus/Menüwerte ändern. Drücken Sie je nach Auswahl nach links/rechts oder hoch/runter.
	Auswahl	Auswahl oder Ausführen eines markierten Elements. Live-TV: Informationen zur aktuellen Sendung anzeigen.
	Zurück	Kurz: Zurück zum letzten Menüpunkt/Live-TV: letzter Sender, Lang: Schließen des Menüs.
	Startbildschirm	Startbildschirm öffnen.
	Play/Pause	Medien wiedergeben/anhalten oder Timeshift (zeitversetztes Fernsehen) starten/pausieren/fortsetzen.
	Lautstärke	Lautstärke erhöhen/verringern.
	Programm	Nächster oder vorheriger Sender.
	Video on-demand	Direktasten zum Starten von Apps und Video-On-Demand Diensten.

Batterien einlegen und wechseln.

## Erste Schritte - Fernbedienung.

1. Öffnen Sie das Batteriefach auf der Rückseite der Fernbedienung. Schieben Sie die Abdeckung des Batteriefachs nach unten. Heben Sie dann die Abdeckung ab. Das Batteriefach liegt nun frei.



2. Richten Sie die erste Batterie mit dem Pluspol so aus, wie es auf der Abbildung auf der Fernbedienung gezeigt wird.

 Achten Sie darauf, dass die Batterien richtig ausgerichtet sind und die Pole entsprechend platziert sind (+ und -).

 Überprüfen Sie, ob die Batterien fest sitzen.

3. Schließen Sie das Batteriefach, indem Sie die Abdeckung wieder anbringen.

Testen Sie nun die Fernbedienung, um sicherzustellen, dass sie ordnungsgemäß funktioniert. Sollte dies nicht der Fall sein, wiederholen Sie die Schritte.





 Das Einsetzen der Batterien funktioniert bei beiden Fernbedienungen identisch.

 Verwenden Sie je Fernbedienung zwei auslaufsichere AAA-Batterien vom Typ LR03 (Alkali-Mangan).







## Kopplung der Loewe remote stellar mini.

Wenn Sie den TV erstmalig einschalten , verbindet sich der TV automatisch mit der Loewe remote stellar mini. Zum manuellen Koppeln richten Sie die Fernbedienung auf die Vorderseite des TV und drücken Sie gleichzeitig drei Sekunden lang die Tasten  und .





 Für die Verwendung der Loewe remote stellar ist keine Kopplung notwendig.

 Batterien außer Reichweite von Kindern aufbewahren. Batterien nicht in die Sonne legen oder in Feuer werfen.

 Entsorgen Sie die leeren Batterien umweltverträglich. Beachten Sie das Kapitel „Umwelt“ in den Sicherheitshinweisen.

## Programmierung der Gerätetasten.

Die TV-Taste  und die Gerätetasten ,  bieten neben der Direktfunktion, durch kurzen Tastendruck auch die Möglichkeit, bei langem Tastendruck die Bedienung anderer Loewe Produkte. Dies ermöglicht eine nahtlose Steuerung von anderen Loewe Audio-Geräten, Blu-ray-Playern und Set-Top-Boxen anderer Hersteller. Die Punkte unter den Tasten symbolisieren den jeweiligen Geräte-Modus:

 Live-TV (1 Sek. drücken),  
Modus: Loewe TV (3 Sek. drücken)

 Eingang (1 Sek. drücken),  
Modus: Loewe klang mr1/3/5 (3 Sek. drücken)

 Aufnahme (3 Sek. drücken),  
Modus: Loewe klang bar3/5 mr (3 Sek. drücken)

## Programmierung für bestimmte Geräte.

Diese Tasten können auch mit bestimmten Geräten belegt werden. Wenn Sie beispielsweise einen Blu-ray-Player oder einen Receiver mit einer der Gerätetasten

verknüpft haben, können Sie weiterhin die Lautstärke und Stummschaltung des TV bequem über die TV-Fernbedienung steuern.

Damit wird das Handling Ihrer Heimunterhaltung noch einfacher und intuitiver gestaltet.

Weitere Informationen zum Programmieren und Anlernen der Loewe remote stellar finden Sie auf der Internetseite von Loewe.

## LED-Ring aktivieren und Helligkeit anpassen.

Um die Helligkeit der LEDs der Richtungstasten zu ändern, halten Sie die Taste  zusammen mit einer der Zifferntasten 1, 2, 3, 4 oder 5 für 3 Sekunden gedrückt.





Die Taste 5 bedeutet höchste Helligkeitsstufe. Die Taste 1 bedeutet niedrigste Helligkeitsstufe des LED-Rings.

Einfach und schnell.

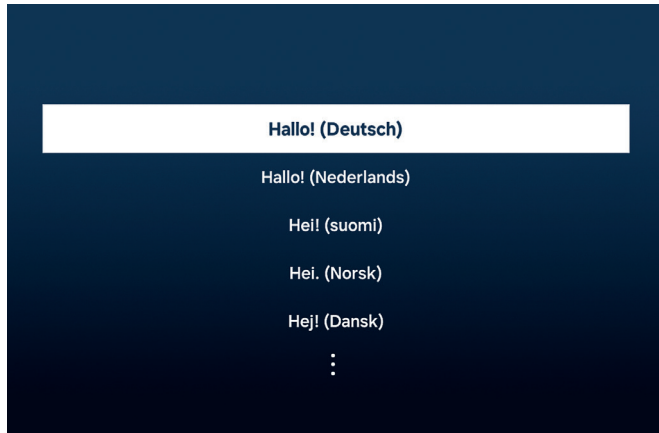
## Erste Schritte - TV Inbetriebnahme.



### Menüsprache wählen.

Im ersten Schritt erfolgt die Auswahl der Menüsprache. Wählen Sie Ihre Sprache über die Richtungstasten  aus. Bestätigen Sie mit der Auswahl taste .



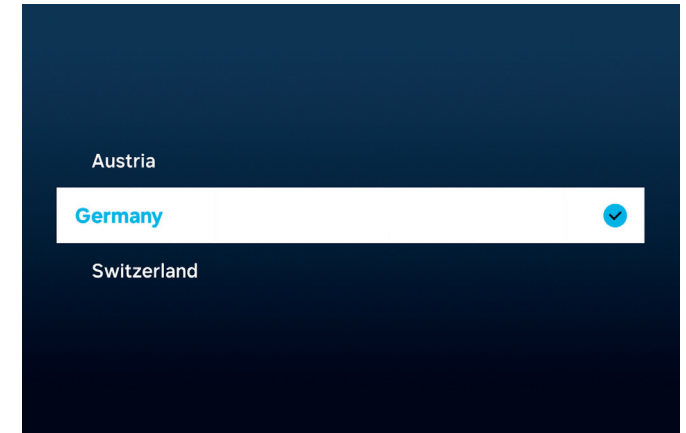

### Ersteinrichtung starten.

Der Loewe stellar verfügt über einen Einrichtungsassistenten. Folgen Sie den Anweisungen des Einrichtungsassistenten.



### Land wählen.

Nun ist die Auswahl Ihres Landes oder Ihrer Region erforderlich. Wählen Sie Land oder Region über die Richtungstasten  aus. Bestätigen Sie mit der Auswahl taste .



Beachten Sie die Sicherheitshinweise und Technischen Daten für dieses Gerät.



Das Aussehen der Benutzeroberfläche kann nach einem Software-Update variieren.

Loewe Customer Care Center  
www.loewe.tv  
Tel +49 9261 99-500  
E-mail: ccc@loewe.de



Regionalangebote können je nach ausgewählter Region variieren.

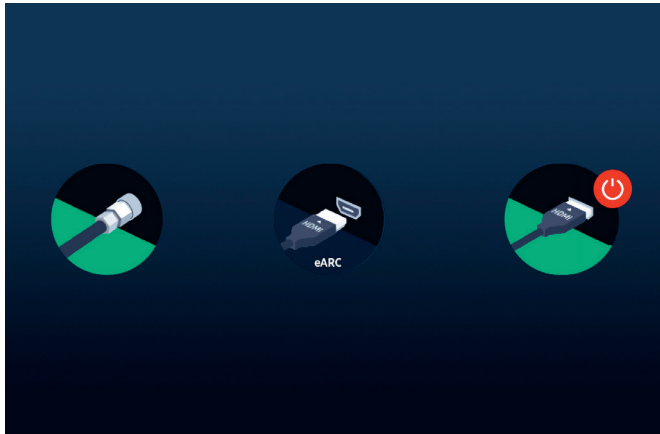

## Automatische Anschlusserkennung.

Loewe stellar erkennt automatisch alle angeschlossenen Antennen und Geräte, die mit USB oder HDMI verbunden sind.

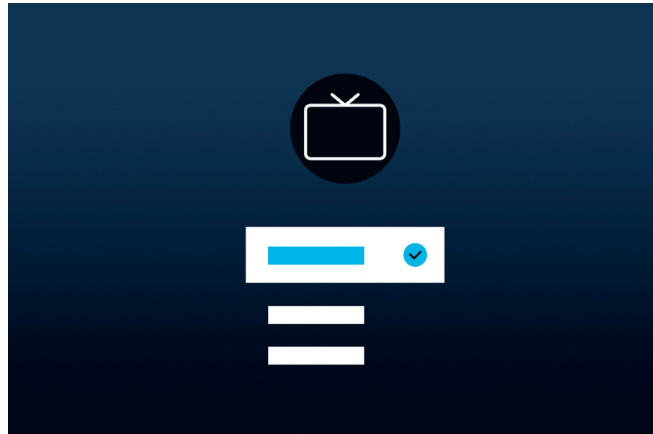

## TV-Empfang und Sendertyp.

Wird ein terrestrisches oder Kabel-Signal erkannt, können Sie nun den TV-Empfangstyp und den Sendertyp auswählen. Im nächsten Schritt werden alle empfangbaren Sender automatisch abgespeichert.

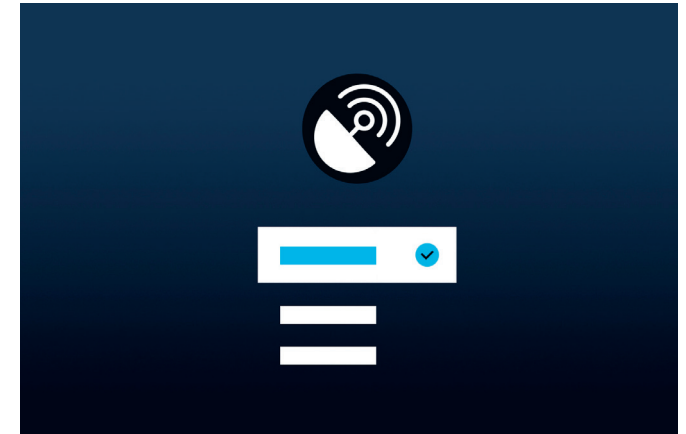

## Satelliten-Signal.

Bei vorhandenem Satelliten-Signal können Sie in diesem Schritt Feineinstellungen durchführen.

Wählen Sie u.a. zwischen Sendertyp, Satellitenauswahl, LNB, Satellit und Suchbereich. Wenn Sie SAT MAIN und SAT SUB nutzen, können Sie an dieser Stelle Dual oder Main einstellen.

 Prüfen Sie, ob alle Geräte eingeschaltet sind.



Gleich geschafft.

## Erste Schritte - TV Inbetriebnahme.

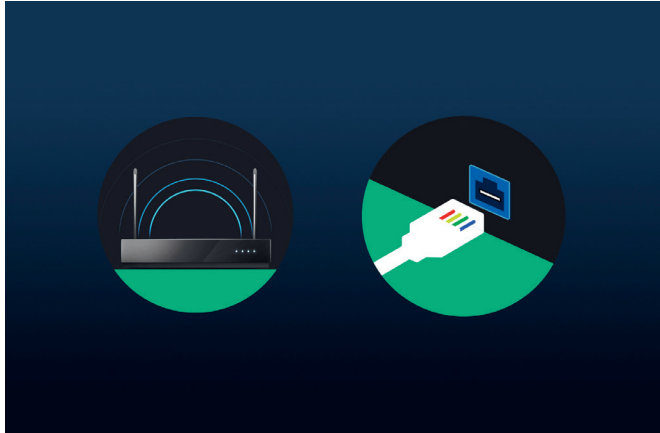

### Netzwerk auswählen.



Um die Vorteile eines modernen Smart-TV zu nutzen, ist eine Internetverbindung erforderlich. Sie können Ihren Loewe TV mit einem Netzwerk via WLAN (kabellos) oder via LAN (kabelgebunden) verbinden.

**WLAN** Einstellung im nächsten Schritt.  
Halten Sie Ihre WLAN-Zugangsdaten bereit.

**LAN** Stellen Sie sicher, dass ein Ende des Kabels mit Ihrem TV und das andere Ende mit Ihrem Router verbunden ist.



### WLAN verbinden.

Bei Verwendung von WLAN werden Sie jetzt aufgefordert, Ihr WLAN-Passwort einzugeben. Nutzen Sie die Richtungstasten  und die Auswahl taste , um Ziffern und Buchstaben zu wählen. Bestätigen Sie mit der Auswahl taste .



### AGB, Datenschutz.

Um alle Gerätefunktionen zu nutzen, akzeptieren Sie die Smart Hub-Geschäftsbedingungen und Datenschutzhinweise.

Mit „Ich stimme allem zu“ stimmen Sie allen Zusatzfunktionen zu. Drücken Sie dazu die Auswahl taste .

 Ohne Zustimmung zu den AGB und zum Datenschutz kann die Funktion einiger Dienste nicht gewährleistet werden.



## Nutzerkonto einrichten.

Optionaler Schritt. Wenn Sie diesen Schritt überspringen möchten, drücken Sie die Richtungstaste  nach rechts. Melden Sie sich bei Ihrem existierenden Samsung-Konto an oder richten Sie ein neues ein. Mit einem Samsung-Konto können Sie die besten Funktionen Ihres Smart-Fernsehgeräts nutzen und es stets auf dem neuesten Stand halten.

 Zum Nutzen von Apps oder VoD ist ein Nutzerkonto erforderlich.

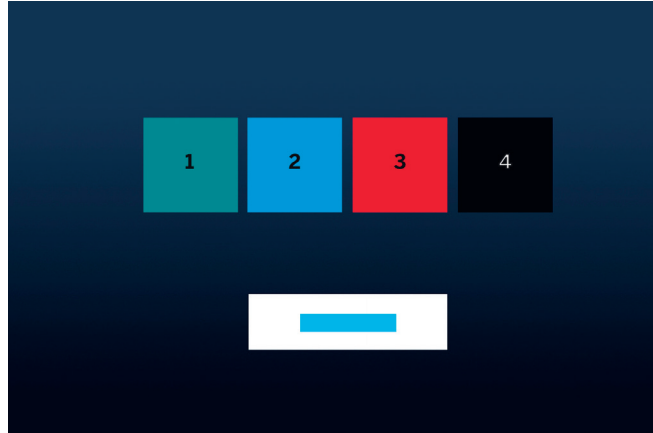

## Startleiste einrichten.

In diesem Schritt können Sie Apps in der Startleiste anlegen oder sortieren. Einige Apps sind bereits vorinstalliert. Apps können auch später im Smart Hub angepasst werden.

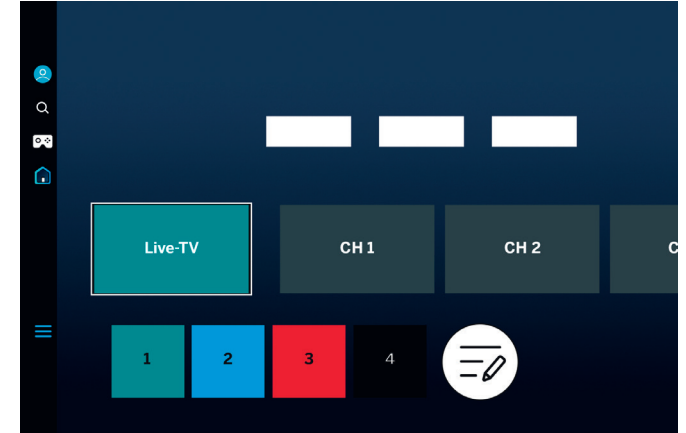

## Startbildschirm.

Mit der Anzeige des Startbildschirms ist die Ersteinrichtung beendet. Um Inhalte zu starten oder linear TV zu sehen, rufen Sie Live-TV oder Ihre Lieblings-App auf. Wir wünschen Ihnen viel Freude mit Ihrem neuen Loewe TV.









Smart-Hub.

# Startbildschirm.

Smart-Hub ist der Startbildschirm Ihres TV. Von hier aus können Sie auf Apps, Dienste und Live-TV zugreifen.

 Mit der Home-Taste auf Ihrer Fernbedienung können Sie direkt zum Startbildschirm zurückkehren.

Ihnen stehen folgende Optionen zur Verfügung:

-  Benutzerprofil: Benutzerprofil abrufen.
-  Suche: Sender, Filme oder Apps suchen. Spracheingabe mit Loewe remote stellar mini.
-  Gaming-Hub: Spiele direkt streamen.
-  Startbildschirm: App-Anordnung ändern.
-  Verbundene Geräte  / Einstellungen 
-  Datenschutzeinstellungen ändern.

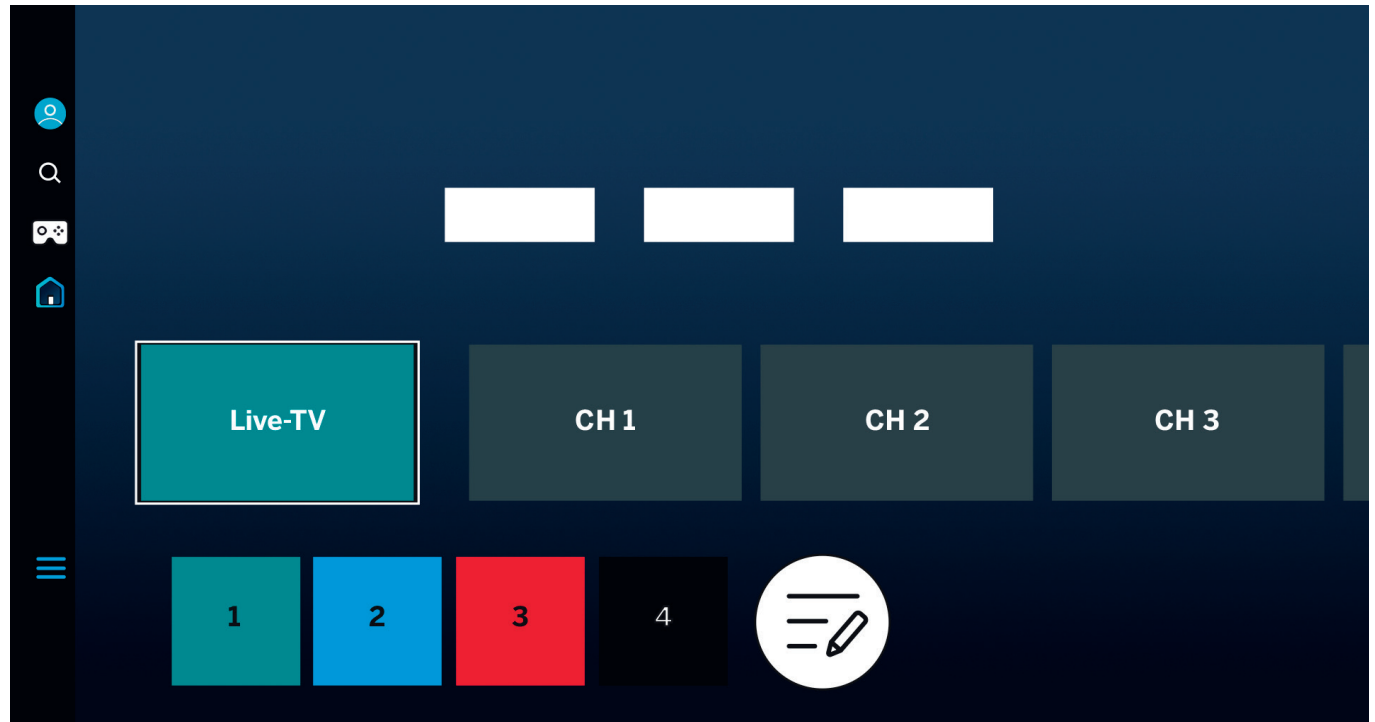

Mit den Richtungstasten  können Sie navigieren. Ihre Auswahl erkennen Sie an einer hell hervorgehoben und etwas vergrößerten Kachel.

Mit der Auswahltaste  können Sie installierte Apps, Dienste oder Live-TV starten. In der linken Bildhälfte befinden sich weitere Optionen: Benutzerprofil, Suche,

Ambient-Modus, Gaming-Hub, Medien und Datenschutz.

 Je nach Land und Region können Anzeige und Informationen variieren.

Alles im Blick.

# Elektronischer Programm-Guide.

Der elektronische Programm-Guide EPG zeigt Informationen zum Fernsehprogramm auf dem Bildschirm. Sie können damit sehen, welche Sendung aktuell läuft und auch Aufnahmen programmieren.

 Mit der Guide-Taste auf Ihrer Fernbedienung können Sie direkt zum Programm-Guide wechseln.

Ihnen stehen folgende Optionen zur Verfügung:

 Senderfilter bearbeiten.

 Nur TV Sender anzeigen.

 Nur Radiostender anzeigen.

 Sender bearbeiten.

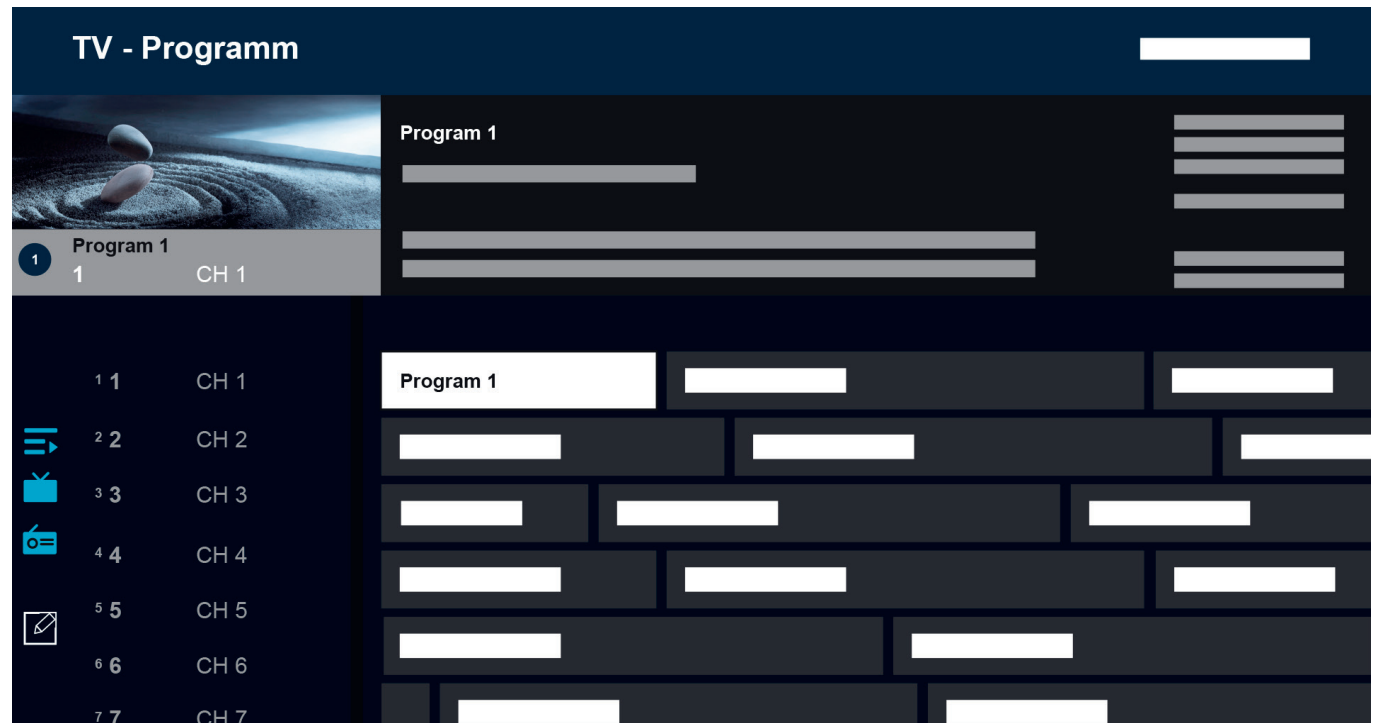

Weitere Funktionen des EPG sind:

- Live-Bildvorschau.
- Informationen zur laufenden Sendung.
- Datum- und Uhrzeitanzeige.
- Programmvorschau aller empfangbaren Sender.
- Loewe remote stellar mini Übersicht.

Weitere Infos zu Aufnahmen erhalten Sie auch im eManual.

 Je nach Land und Region können Anzeige und Informationen variieren.





Aufnahme mit dr+.



## Multi-Aufnahme.

Mit Loewe stellar können Sie Sendungen aufnehmen, eine Aufnahme planen und mit Timeshift zeitversetzt fernsehen. Beim Nutzen der Aufnahmefunktion werden Sendungen automatisch auf der eingebauten Festplatte aufgenommen. Sie können jedoch auch einen geeigneten externen USB-Speicher nutzen.

## Sofortige Aufnahme.

Wählen Sie im Live-TV die Sendung, die Sie aufnehmen möchten. Drücken Sie die Aufnahmetaste  oder , und anschließend im Popup-Menü die Option „Aufnahme “.

## Aufnahme Programmieren.

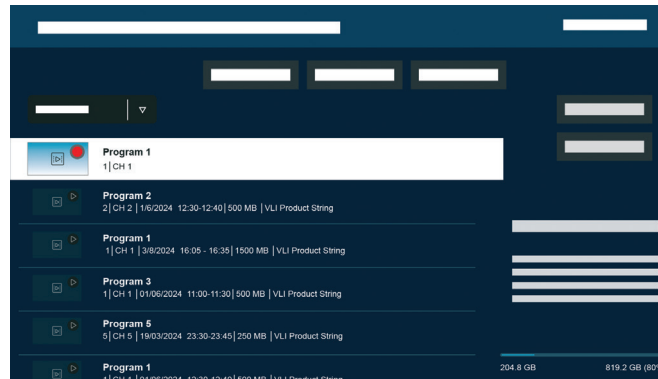

Wählen Sie im EPG mit den Richtungstasten , eine Sendung aus, die Sie aufnehmen möchten. Drücken Sie nun die Auswahltaste . Wählen Sie im Popup-Menü die Option „Aufnahme programmieren“. Manuelle Aufnahmen können Sie im Programmmanager planen.



## Aufnahme- und Programmmanager.



Der Aufnahme- und Programmmanager gibt Ihnen einen Überblick über bereits durchgeführte oder geplante Aufnahmen.

## Aufnahmen.

Die Liste der verfügbaren Aufnahmen erhalten Sie im Live-TV, indem Sie  drücken und mit den Richtungstasten  wählen. Zur Wiedergabe selektieren Sie die gewünschte Aufnahme und starten diese mit der Auswahltaste .



## Programmierung.

Die Übersicht zu den geplanten Aufnahmen erhalten Sie im Live-TV, indem Sie  drücken und mit den Richtungstasten  wählen.

Über "Aufnahmen hinzufügen" haben Sie die Möglichkeit, manuelle Aufnahmen, auch als Serie, zu programmieren.

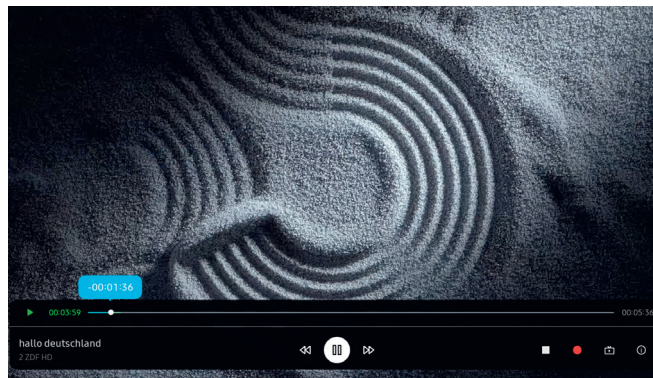
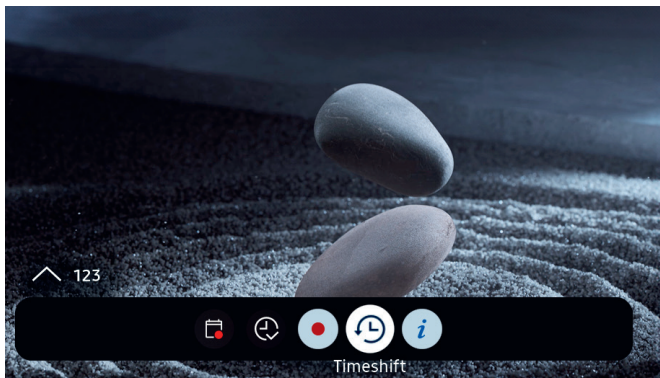

## Timeshift.

Um Timeshift zu aktivieren, drücken Sie .

Ist Timeshift aktiv, können Sie eine Sendung pausieren und zu einem späteren Zeitpunkt fortsetzen oder bereits gesehene Abschnitte erneut ansehen.

 Maximale Timeshift-Kapazität: 90 Minuten.

Um den Fortschrittsbalken mit Timeshift-Menü anzuzeigen, drücken Sie die Richtungstaste runter .

Navigieren Sie mit den Richtungstasten durch das Timeshift Menü.

## Timeshift-Menü:

 Timeshift Play/Pause.

 Schnell Vorspulen.

 Rückspulen.

 Timeshift beenden.

 Aufnahme starten.

 Live-TV: Zurück zu Live-TV.  
Timeshift bleibt aktiv.

 Info.

Lesen Sie vor der Verwendung der Funktion Timeshift alle Sicherheitshinweise. Beachten Sie das Kapitel "Informationen über angeschlossene USB-Festplatten". Ein Trennen vom Stromnetz kann zu Datenverlust führen.

Weitere Informationen erhalten Sie im Abschnitt „Vor Verwendung der Funktionen Aufnahme und Timeshift“ im eManual.

Ein leuchtender Empfang.

# Loewe magic.light

Loewe Stellar Fernsehgeräte sind mit dem integrierten Loewe magic.light ausgestattet: Diese versteckte LED-Leiste bietet diskrete Beleuchtungsanimationen zur Begrüßung und Verabschiedung oder eine atmosphärische Beleuchtung in warmem Weiß während des Filmsehens.

Konfigurieren Sie magic.light individuell und passen Sie die indirekte Beleuchtung ganz auf Ihre Wünsche und die aktuelle Stimmung an. Im folgenden Abschnitt erfahren Sie, wie Sie magic.light einstellen können:

Einstellungen aktivieren:

- ☀️ Drücken Sie die Taste magic.light und danach die Auswahltaste ⏪.

- ⏪ Lichtband ein- oder ausschalten.

- ⬅️ Helligkeit anpassen mit den Richtungstasten.

- ⬆️ Sättigung anpassen mit den Programmtasten.

- 🎨 Farbe einstellen mit den Richtungstasten.



Warmweiß: 100% Sättigung  
Kaltweiß: 0% Sättigung



## Leuchtdauer einrichten.

1. LichtTaste ☀️ und die Einstellungstaste ⚙️, für fünf Sekunden gedrückt halten. Im Loewe signature.ring erscheint nun eine Linie aus sieben weißen Punkten. Die Punkte geben die Leuchtdauer an:

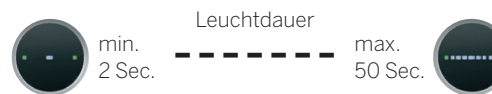

2. Stellen Sie nun die Leuchtdauer ein. Wenn Sie nach links ⬅️ oder rechts ➡️ drücken, verändert sich die leuchtende Linie im Loewe-Auge.
3. Drücken Sie die Auswahltaste ⏪, um Ihre Einstellungen zu speichern.

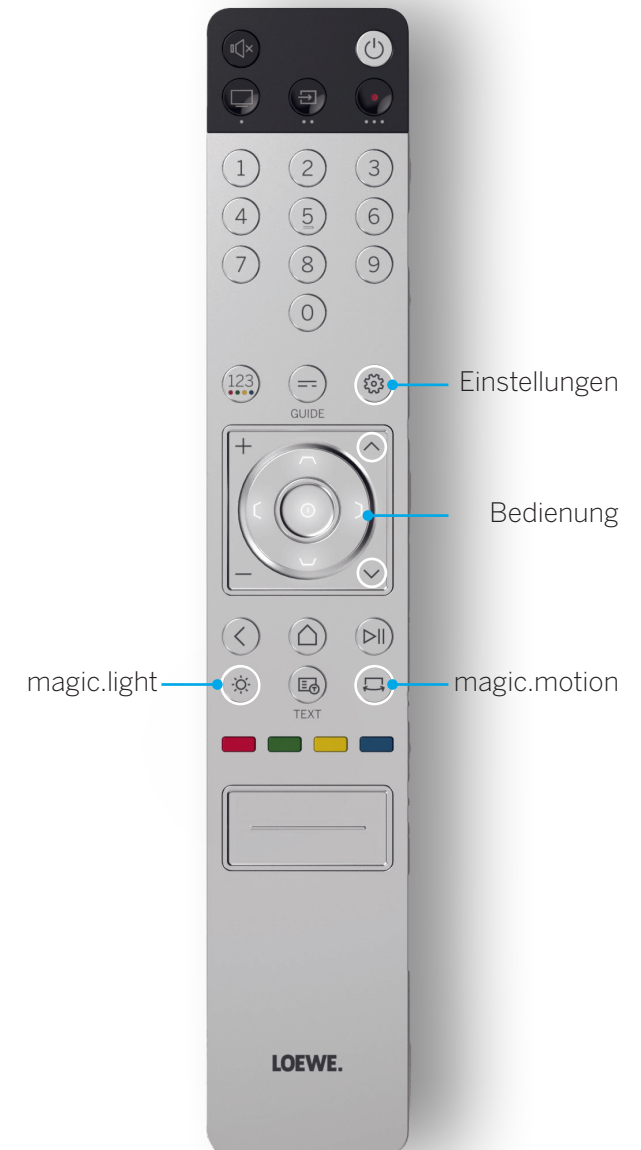

Der richtige Blickwinkel.

## Loewe magic.motion

Die Funktion Loewe magic.motion ermöglicht es, den motorisierten, optionalen Loewe floor stand motor stellar per Knopfdruck auf der Loewe remote stellar zu drehen.

Die Loewe remote stellar besitzt für diese Option die Taste magic.motion .

---



 Drücken Sie die Taste magic.motion.

---







 Drücken Sie die Richtungstasten, um den TV zu drehen. Maximale Drehung 45°

---

### Drehmodus einrichten.

Drücken Sie für fünf Sek. die Taste  und die Einstellungstaste  gleichzeitig. Sie hören einen kurzen Signalton. Der Einrichtungsmodus ist jetzt aktiv.

Mit Links-Rechtstaste  können Sie den TV entsprechend drehen.

1. Drücken Sie die Linkstaste  bis die maximale Drehung Links erreicht ist. Speichern Sie diese Position mit der Auswahlstaste . Sie hören zwei kurze Töne zur Bestätigung.
2. Drücken Sie die Rechtstaste  bis die maximale Drehung Rechts erreicht ist. Speichern Sie diese Position mit . Sie hören drei kurze Töne.
3. Drücken Sie nun erneut die Linkstaste und drehen Sie das Gerät in die gewünschte Ausschaltposition. Drücken Sie die , um diese Position zu speichern. Jetzt hören Sie vier kurze Töne.
4. Drücken Sie zum Schluss noch einmal die Auswahlstaste , um zu bestätigen, dass dies nun die Standardposition beim Ein- und Ausschalten ist.
5. Sie hören nun einen langen Ton. Der Einrichtungsmodus ist beendet.



Hinderniserkennung: magic.motion stoppt automatisch bei Widerstand.



20 Sekunden ohne Tastendruck beendet automatisch den Einrichtungsmodus.



Wichtig zu wissen.

# Apps und Technische Informationen.

## my Loewe App laden.

Scannen Sie mit Ihrem Smartphone den unten stehenden QR Code und laden Sie die empfohlene App herunter. "my Loewe" ist der Einstiegspunkt in die Welt von Loewe und bietet Ihnen Zugriff auf alle Benutzerhandbücher für Ihre Produkte von Loewe.



## Technische Informationen.

Sie haben ein Fernsehgerät mit OLED-Bildschirm erworben, das höchsten Qualitätsansprüchen genügt und auf Pixelfehler geprüft wurde. Trotz größter Sorgfaltspflicht bei der Herstellung des Displays kann aus technischen Gründen nicht zu 100% garantiert werden, dass keine Subpixelfehler auftreten. Diese Effekte werden jedoch, solange sie innerhalb der Grenzen liegen, die in der Norm (ISO 9241-307, Fehlerklasse II) festgelegt sind, nicht als Gerätedefekt im Sinne der Gewährleistung angesehen. Organic Light Emitting Diodes (organische Leuchtdioden) sind eine Bildtechnologie, die auf selbstleuchtenden Bildpunkten basiert und deutliche Vorteile in Bezug auf Bildqualität und Leistung bietet. Unter bestimmten Umständen können bei anhaltender, einseitiger Belastung des OLED-Materials bleibende und irreversible Bildfehler entstehen. Solche Restbildprobleme treten auf, wenn das Fernsehgerät statische Bildinhalte wie statische Bilder, Untertitel, Laufschriftanzeigen, Diashows oder Videosequenzen in Endlosschleife, statische Anzeigen bei einem Präsentationsmonitor oder bei Videospiele anzeigt. Auch schwarze Balken bei manchen Bildschirmformaten können zu Restbildproblemen

führen. Es ist wichtig zu betonen, dass diese Restbildprobleme keine Mängel im Sinne der Gewährleistung darstellen. Wenn statische Bilder zu lange angezeigt werden, reduziert das Gerät den Kontrast automatisch oder schaltet den Bildschirm schoner an. Bei der nächsten Benutzerbedienung kehrt das Gerät sofort in den Normalzustand zurück. Unter normalen Anzeigebedingungen treten keine solchen Restbildprobleme auf. Um die hohe Qualität der Bilddarstellung dauerhaft zu erhalten, kalibriert sich Ihr Loewe OLED TV in regelmäßigen Abständen.

## Angeschlossene USB-Festplatten.

Das Trennen des TV-Gerätes vom Netz während des Betriebes oder eine versehentliche Unterbrechung der Stromversorgung (z.B. Stromausfall) kann zu einer Beschädigung des Festplatten-Dateisystems und damit zum Verlust der aufgezeichneten Sendungen führen. Trennen Sie niemals das USB-Speichergerät vom Fernsehgerät. Wir empfehlen Ihnen, das Fernsehgerät in den Standby-Modus zu schalten, bevor Sie es vom Stromnetz trennen. Loewe übernimmt keine Haftung für den Verlust von Daten, die auf der integrierten Festplatte Ihres Fernsehgerätes gespeichert sind.

## Software-Update.

Aktuelle Software-Versionen können von der (unten angegebenen) Loewe-Internetseite heruntergeladen und mithilfe eines USB-Sticks auf Ihrem Fernsehgerät installiert werden. Wenn Ihr Fernsehgerät mit dem Internet verbunden ist, können Sie es direkt über das Internet aktualisieren.

Weitere Informationen zum Software-Update finden Sie im Benutzerhandbuch, das auf der Loewe-Internetseite als Download zur Verfügung steht. Es kann nicht gewährleistet werden, dass Loewe Modelle von Anfang an und dauerhaft mit allen anschließbaren Peripheriegeräten funktionieren.

## Haftungsausschluss für digitale Dienste.

Bei unseren TV-Geräten handelt es sich um „Produkte mit digitalen Elementen“, deren Kernfunktionen, wie z.B. TV-Empfang über Kabel oder Satellit oder Abspielen von DVDs/Blu-rays über einen an das TV-Gerät angeschlossenen Player grundsätzlich auch ohne diese digitalen Elemente genutzt werden können. Die auf dem Gerät zur Verfügung stehenden digitalen Elemente umfassen unter anderem Apps, Spiele, Musik, Videodienste und andere Programme sowie Plattformen, welche das Herunterladen von weiteren Apps und/oder den Zugriff auf diese ermöglichen. Die vorstehend nicht abschließend genannten Dienste, Inhalte und/oder Elemente sowie die dafür erforderlichen Serverplattformen, auf die diese im Hintergrund über das Internet zugreifen, werden durch Drittanbieter angeboten und/oder bereitgestellt. Bitte beachten Sie hierzu die jeweiligen Endnutzer- und/oder Geschäftsbedingungen dieser Drittanbieter, denen Sie insbesondere bei der Erstinstallation des TV Gerätes, aber auch bei der Inanspruchnahme von Diensten Dritter zu einem späteren Zeitpunkt zustimmen müssen. Durch diese Zustimmung kommt eine unmittelbare Vertragsbeziehung über die Nutzung der jeweiligen digitalen Elemente, Dienste und/oder Inhalte zwischen Ihnen und den jeweiligen Drittanbietern zustande. Die

# Herstellereklärung. Impressum.

Loewe Technology GmbH als TV-Gerätehersteller hat keinen Einfluss auf die Bereitstellung der digitalen Elemente, Dienste und Inhalte, deren Qualität, die visuelle Darstellung, die Bereitstellung von Aktualisierungen und insbesondere das Ende der Zurverfügungstellung (End of Life) dieser digitalen Elemente, Dienste und Inhalte. Auf der anderen Seite können während der Produktlebensdauer des TV-Gerätes auch neue digitale Elemente, Dienste und/oder Inhalte auf dem Gerät angeboten werden, ohne dass Sie dazu regelmäßig Ihre Einwilligung erteilen. Diese zusätzlichen digitalen Elemente, Dienste und/oder Inhalte resultieren unter anderem aus dem technischen Fortschritt und den allgemeinen Marktanforderungen. Eine Pflicht, neue digitale Elemente, Dienste und/oder Inhalte bereitzustellen, besteht jedoch nicht. Insbesondere besteht keine Pflicht, nach dem End of Life eines digitalen Elements, Dienstes oder Inhalts einen Ersatz oder einen Nachfolger bereitzustellen. Bitte beachten Sie die jeweiligen für Ihr Gerät gültigen Endnutzer- und/oder Geschäftsbedingungen.

Die Loewe Technology GmbH bestätigt, dass ihr Produkt den grundlegenden Anforderungen der Richtlinie 2014/53/EU, sowie anderen relevanten EU-Richtlinien entspricht.

Im Frequenzbereich 5150 bis 5350 Mhz darf diese Fernsehgerät in den folgenden Ländern nur in Innenräumen verwendet werden:

Belgien, Bulgarien, Dänemark, Deutschland, Estland, Finnland, Frankreich, Griechenland, Irland, Italien, Kroatien, Lettland, Litauen, Luxemburg, Malta, Niederlande, Österreich, Polen, Portugal, Rumänien, Schweden, Slowakei, Slowenien, Spanien, Tschechische Republik, Ungarn, Vereinigtes Königreich, Zypern.

Hier finden Sie die vollständige Konformitätserklärung in der Produktauswahl:

**[www.loewe.tv/eu/en/service/support](http://www.loewe.tv/eu/en/service/support)**

Loewe Technology GmbH  
Industriestraße 11  
96317 Kronach, Deutschland  
[www.loewe.tv](http://www.loewe.tv)

Tel.: 09261 99-0  
E-Mail: [ccc@loewe.de](mailto:ccc@loewe.de)

Registergericht: Frankfurt am Main, HRB 117013  
vertreten durch: Aslan Khabliev

Die Informationen in diesem Dokument können ohne vorherige Ankündigung geändert werden und stellen keinerlei Verpflichtung von Seiten der Loewe Technology GmbH dar.

Alle Rechte vorbehalten. Einschließlich Übersetzung, technische Änderungen und Irrtümer.







# Loewe stellar. Made in Germany.

## Welcome.

Thank you very much for choosing Loewe stellar. We are elated to welcome you as a customer. Design, innovation and cutting edge technology - you chose a device that unites all these qualities in one premium product. This OLED TV model from Loewe captivates its audience through the most modern display technology, performance hardware and a new design language.

### Loewe stellar is made in Germany.

Every detail of this product reflects the dedication and craftsmanship that has distinguished Loewe and its employees for over 100 years. Enjoy the unique lighting concept of Loewe stellar and make every moment with this remarkable product line a Magic Moment. Loewe dual-channel dr+ with a triple tuner opens up a new TV experience - enjoy multi view and multi recording in flawless quality.

For gaming enthusiasts, stellar offers full support for HDMI 2.1 and Ultra HD @ 144 Hz VRR, for a super fast, seamless gaming experience. Our comprehensive range of streaming apps and VOD services, powered by premium Tizen OS, ensures entertainment for everyone.

Please read these instructions carefully. To ensure that you can enjoy your Loewe product for a long time to come, please observe the safety instructions that are

enclosed separately. If you have any questions or need help, Loewe Customer Care is always at your disposal.



In this section of the user manual, you will find important basic information on how to install your Loewe TV. After switching it on for the first time, an intuitive commissioning guide will lead you through the setup process.

A detailed eManual is available for download on the Loewe website. It provides comprehensive descriptions of the functions and features of your new Loewe TV.



[www.loewe.tv](http://www.loewe.tv)

### Table of contents.

Welcome.	29
Symbols and type plate.	30
Scope of delivery.	31
Overview - TV.	32
First steps - TV installation.	34
Overview - Remote.	36
First steps - Remote.	38
First steps - Initial setup.	40
Home screen.	44
Electronic programme guide.	45
Multi-recording.	46
Loewe magic.light	48
Loewe magic.motion	49
Apps and technical information.	50
Declaration.	51
Imprint.	51



Symbols and their meaning.

## Symbols and rating plate.

This user manual features numerous symbols, whose meanings are explained on this page. Read this section carefully and note their meanings.

The type plate contains important information about the device:

- Device name
- Device type
- Article number
- Serial number



Warnings draw attention to issues that may endanger your health or life, or the health or life of others. Pay attention to the warnings.



Environmental notices contain information on environmentally conscious action or environmentally conscious disposal. Pay attention to the environmental information.



General hints and tips in scope with the device or an application of the device.



Electronics notices draw attention to dangers that, if ignored, could damage the device or endanger your health or life.



Breakage hazard warnings indicate that there is a risk of damage to your device or that injury is possible. Pay attention to the breakage hazard warnings.

Position of the rating plate.

Label with model number and operating voltage can be found on the back of the TV set.

Rating plate example:



**stellar.65**

Ultra HD / OLED / CI+ / DR+

Art.No. 63470 B 10 Ser.No. 00001 / 3463

CH-TYP SL950

220-240V~ 50/60Hz 450 W



**LOEWE.**

Loewe Technology GmbH  
Industriestraße 11  
D-96317 Kronach

Manufactured  
in Germany

Everything you need.

## Scope of delivery.

Make sure all the contents of the packaging and the Loewe welcome box are present. If anything is missing, please contact your dealer or the Loewe Customer Care Center.

### Contents.

- Loewe quick start guide
- User manual (this document)
- Loewe stellar
- Stand
- Power cord
- Loewe welcome box
  - Loewe remote stellar
  - Loewe remote stellar mini
  - Batteries type AAA
  - Technical data table stellar
  - Loewe OLED safety instructions
  - Assembly instructions for the stand
  - Mounting kit for the stand



Front.  
**Overview - TV.**



- ① Loewe signature.ring

---

- TV status LED

  - Standby
  - TV ON: Panel ON
  - TV ON: Panel OFF
  - TV Standby: OLED-Refresh
  - Recording active
  - Timeshift active

---

- ② Loewe table stand stellar \*

---

- ③ Loewe magic.light

---

- ④ Soundbar

---

- ⑤ OLED screen

---

- ⑥ Loewe signature.flag

\*Depending on variant and size.

Back.



① AC-IN	Mains connection - 220-240 V - 50/60Hz
② LAN*	Network connection RJ-45
③ HDMI 1	HDMI 2.1 with eARC Audio-OUT
④ HDMI 2	HDMI 2.1 input
⑤ HDMI 3	HDMI 2.1 input
⑥ USB-A	USB 2.0 - 5V $\overline{=}$ , 2000 mA max.
⑥ USB-A	USB 2.0 - 5V $\overline{=}$ , 2000 mA max.
⑦ USB-C	USB 3.1 - 5V $\overline{=}$ , 1000 mA max.
⑧ ANT SAT	Satellite jack - DVB-S/S2 HD
	SUB 13/18V, 400mA
⑨ ANT SAT	Satellite reception DVB-S/S2 HD
	MAIN 13/18V, 400mA
⑩ ANT TV	Terrestrial/TV antenna DVB-C/T/T2 HD
⑪ Common Interface	CI+ V1.4
⑫ HDMI 4	HDMI 2.1 input
⑬ Audio Out Toslink	Audio output jack 3.5mm/ TOSLINK
⑭ USB-A	USB 2.0 - 5V $\overline{=}$ , 2000mA max.
⑮ USB-C	USB 3.1 - 5V $\overline{=}$ , 1000 mA max.

\*The use of a Cat5 LAN cable without shielding is recommended.



Unboxing and connecting.

# First steps - TV installation.



## 1. Unboxing the TV.

If you haven't unboxed your TV yet, follow the simple steps in the quick start guide. Proceed to step 2 of this guide, once you have securely attached the TV to the stand.



## 2. Connecting the antenna cables.

Now connect the satellite or antenna cable. The labeled ports are located on the back of the TV. To expose the ports, carefully remove the covers. They are easy to remove. No tools are required.

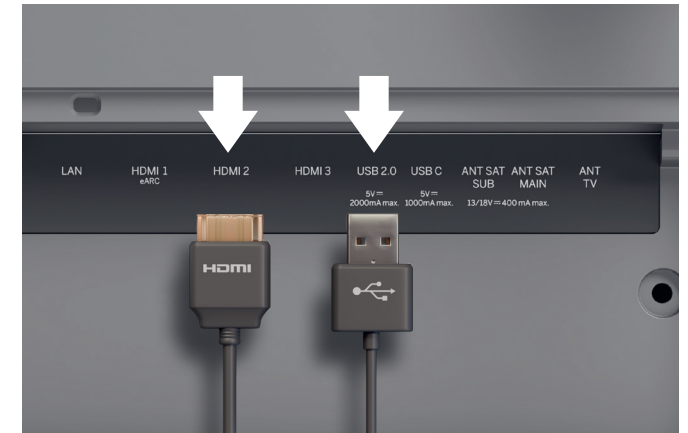



## 3. Connecting additional devices.

Additional devices, such as game consoles or storage devices, can be connected via HDMI and USB. Details are available on the help pages in the eManual and on the Loewe website.

 Pay attention to the safety instructions and technical specifications.

 This information is necessary for the safe setup and operation of the TV.

 Connect the cables to the TV first, then to the satellite system or cable connection. Use the cable guide on the TV and the delivered Loewe stand.

 Unplug all devices from the power grid before connecting them.



#### 4. Network via LAN.

You can connect the TV to a LAN network. Connecting to a Wi-Fi network is explained in the "First steps - initial setup" section below.

**i** To connect to the LAN, use an RJ45 CAT7 cable (10/100 Mbit/s).



#### 5. Audio via HDMI eARC.

You can connect a Loewe klang bar or your sound system to the TV via a HDMI cable. To do this, use the HDMI 1 port, which supports HDMI 2.1 with eARC audio OUT.

**i** Use an HDMI "ultra-high-speed" cable, type-A connector (not included), for the highest video resolution and eARC.

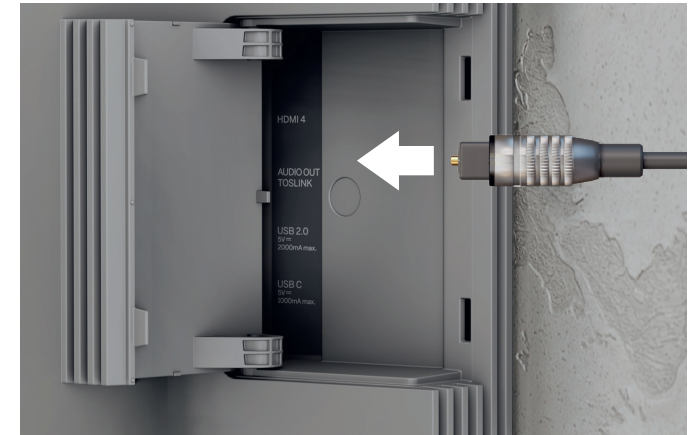

#### 6. Audio: Mini-TOSLINK/analogue.

You can connect an audio system via TOSLINK to the TV. The type of connection depends on your audio system. Connect the "AUDIO OUT TOSLINK" output on the TV to the audio system.

Digital: Use a mini-TOSLINK to TOSLINK optical cable.

Analogue: Use a stereo RCA to jack adapter cable for to connect the audio system to the TV.

Two for one.

# Overview - Remote.

## Loewe remote stellar



**i** Additional features  
Loewe magic.light  
Loewe magic.motion











	ON/OFF	Switch TV ON/OFF
	Mute	Mute/unmute sound.
	TV-mode	Short press: Live TV, long press: Switch to TV device 1.
	Input	Short press: Open device list, long press: Switch to device 2.
	Recording	Short press: Start recording, long press: Switch to device 3.
	Programme	Select channels directly by pressing the numeric keys.
	123-Function	Live TV: Recording menu, programme manager, recording, Timeshift.
	Guide	Short press: Open EPG, long press: Open channel list.
	Settings	Short press: Open settings, long press: Open all settings.
	Direction	Change the selected element or value inside a menu. Press left/right/up/down to navigate.
	Selection	Select/start the currently selected element. Live TV: Show details for the current programme.
	Volume	Increase/decrease volume.
	Channel	Next/previous channel.
	Back	Short press: Back to last menu, live TV: Previous channel, long press: Close menu.
	Home screen	Open home screen.
	Play/pause	Play/pause media or start/pause/continue Timeshift.
	magic.light	Open settings for magic.light. See section "Loewe magic.light".
	Teletext	Open/close teletext and mediatext.
	magic.motion	Activate motor control of magic.motion. See section "Loewe magic.motion".
	Function	Menu-dependent function keys.
	Apps	Shortcut keys to start apps and video on demand services.

\*optional

## Loewe remote stellar mini



 Additional feature  
Audio voice command

	ON/OFF	Switch TV ON/OFF.
	123-Funktion	Enter numbers and change colours. Live TV: Recording menu, programme manager, recording, Timeshift.
	Microphone	Press to enable voice command control.
	Settings	Short press: Open settings.
	Direction	Change the selected element or value inside a menu. Press left/right/up/down to navigate.
	Selection	Select/start the currently selected element. Live TV: Show details for the current programme.
	Back	Short press: Back to last menu, live TV: Previous programme, long press: Close menu.
	Home screen	Open home screen.
	Play/pause	Play/pause media or start/pause/continue Timeshift.
+/-	Volume	Increase/decrease volume.
^/∨	Channel	Next/previous channel.
	Video on demand	Shortcut keys to start apps and video on demand services.

Inserting and changing batteries.

## First steps - Remote.

1. Open the battery compartment on the back of the remote control. Slide down the battery compartment cover, then lift it off. The battery compartment is now exposed.



2. Align the first battery with the positive terminal as shown in the image on the remote control.

 Make sure the terminals (+ and -) are aligned correctly.

 Check if the batteries are held securely.

3. Slide the cover back on and close the battery compartment.

Now, test the remote control to make sure it is working properly. If this is not the case, repeat the steps.





 Inserting the batteries works identically for both remote controls.

 Use leak-proof AAA LR03 (alkaline manganese) batteries only. You need two batteries per remote control.







## Pairing the Loewe remote stellar mini.

When you switch on  the TV for the first time, it automatically connects to the Loewe remote stellar mini. To manually pair the remote with the TV, point it at the front of the TV and press the  and  keys simultaneously for three seconds.





 Pairing the Loewe remote stellar is not necessary.

 Keep batteries out of reach of children. Do not place batteries in the sun or throw them into fire.

 Dispose of empty batteries in an environmentally friendly manner. For more information, please refer to the chapter Environment/Legal Notices.

## Programming the device buttons.

In addition to the direct function, the TV key  and the device keys  and  also offer the option of operating other Loewe devices at the touch of a button. This feature allows for seamless control of other Loewe audio devices, Blu-ray players and set-top speakers from other manufacturers. The dots below each key symbolize the respective function.

---

 Live TV (1 sec press),  
Mode: Loewe TV (3 sec press)

---

 Input (1 sec press),  
Mode: Loewe klang mr 1/3/5 (3 sec press)

---

 Recording (3 sec press),  
Mode: Loewe klang bar 3/5 mr (3 sec press)

---

## Programming to other devices.

These keys can also be assigned to other devices. For example, if you have a Blu-ray player or cable receiver linked to one of the device buttons, you can conveniently control volume and mute from the remote control. This makes handling your home entertainment system

even easier and more intuitive. Further information on how to program the Loewe remote stellar is available on the Loewe website.

## Activate LED ring and adjust brightness.



Press and hold the  key and one of the numerical keys 1, 2, 3, 4 or 5 at the same time for three seconds to change the brightness of the LEDs for the directional keys.



"1" corresponds to the lowest brightness setting, "5" to the highest. Change the key illumination according to your liking.

Fast and easy.

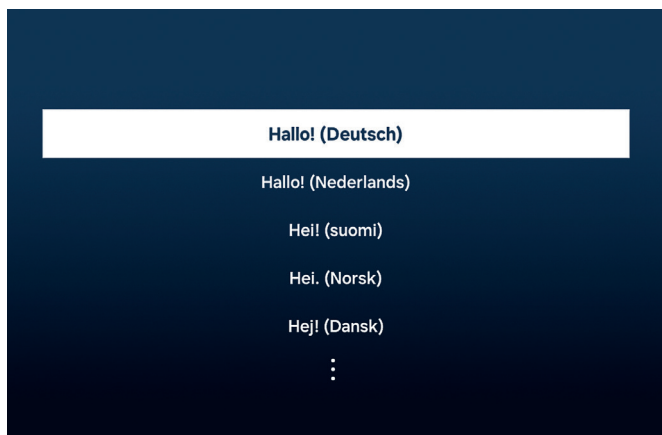
## First steps - Initial setup.



Selecting your menu language.

First, select your language for the menu. Change the language with the directional keys . Confirm with .



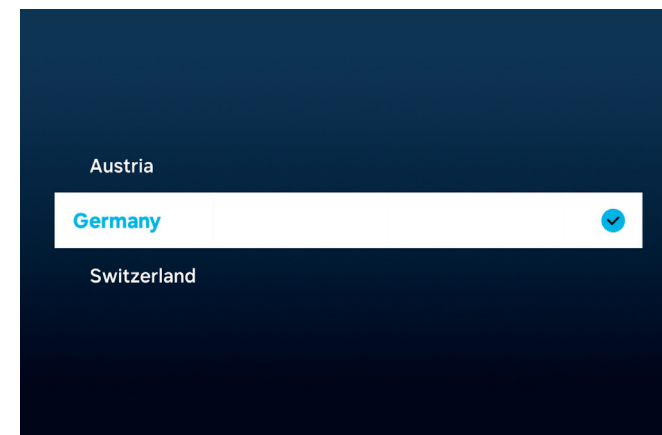

Starting the initial setup.

Loewe stellar features a guide for the initial setup. Follow its instructions.



Selecting your country.

Now select your country or region by using the directional keys . Confirm with .



Pay attention to the safety instructions and technical specifications for this TV.



The appearance of the user interface may change after a software update.

Loewe Customer Care Center  
[www.loewe.tv](http://www.loewe.tv)



Available services may vary depending on the selected region.

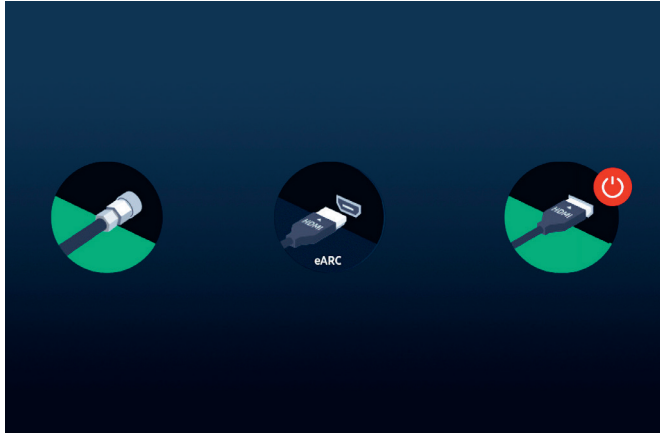

## Automatic connection recognition.

Loewe stellar automatically recognizes all connected antennas and devices connected via USB or HDMI.

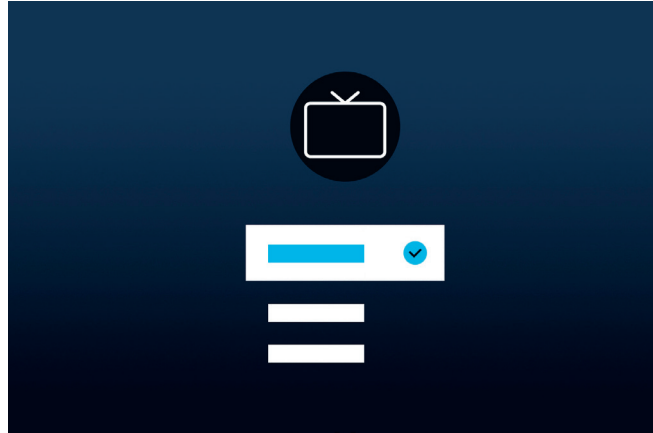

## TV reception and programme type.

After a terrestrial or cable signal has been recognized, select the TV reception and programme type. In the next step, all available channel will be saved automatically.



## Satellite signal.

If there is a satellite signal available, you can make fine adjustments in this menu.

Adjust programme type, satellite selection, LNB, satellite and search range. When using SAT MAIN and SAT SUB, you can choose between dual or main in this menu.



Check if all devices are switched on.

Almost done.

## First steps - Initial setup.

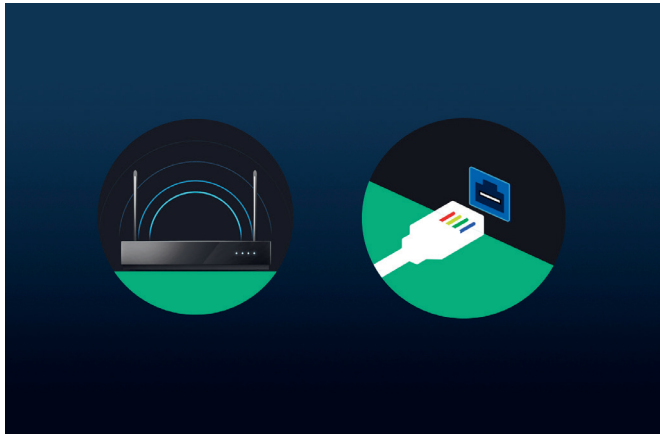

### Selecting a network.



To use a modern smart TV to its full potential, an internet connection is required. You can connect your Loewe TV to a network via WLAN (wireless) or LAN (wired).

**WLAN** Explanation in the next step. Have your WLAN credentials ready.

**LAN** Make sure one end of the network cable is connected to your TV and the other end to your router.





### Connecting to WLAN.

When using WLAN, you'll now be asked to enter your password. Use the directional keys  and the select key , to select numbers and letters. Confirm with .



### T&Cs, privacy policy.

To use all features of the device, you need to accept the Smart Hub terms and conditions and privacy policy. Press the select button  and click on "I agree with everything" to do this.

 Without accepting the terms and conditions and privacy policy, the functioning of some services cannot be guaranteed.



## Creating a user account.

Optional step: Press the directional key  to skip this step. Sign in to an existing Samsung account or create a new one. By using a Samsung account, you benefit from the best features of your smart device and always keep it up to date.

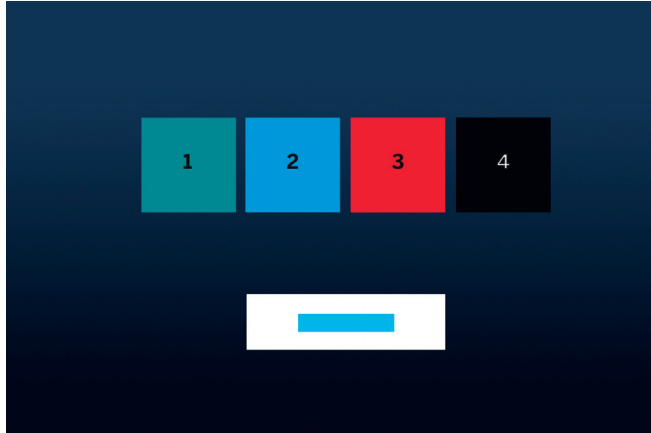

## Customizing the task bar.

In this step, you can save and sort apps in the task bar. Some apps are already pre-installed. Apps can also be customized later in the Smart Hub.



## Home screen.

Once the home screen appears, the initial setup is complete. It's time to start your TV experience. Open live TV or your favorite app. We hope you enjoy your new Loewe TV.

 A user account is necessary to use apps or video on demand.











Smart-Hub.

# Home screen.

The smart hub is the home screen of your TV. From here you can launch apps, services or delve into live TV.

 Press the home key on your remote to immediately return to this screen.

The following options are available to you:

-  User profile: Access user profile.
-  Search: Search for channels, movies, or apps. Voice command with Loewe remote stellar mini.
-  Gaming-Hub: Stream games directly.
-  Home screen: Change the app arrangement.
-  Connected devices  / Settings 
-  Change privacy settings.

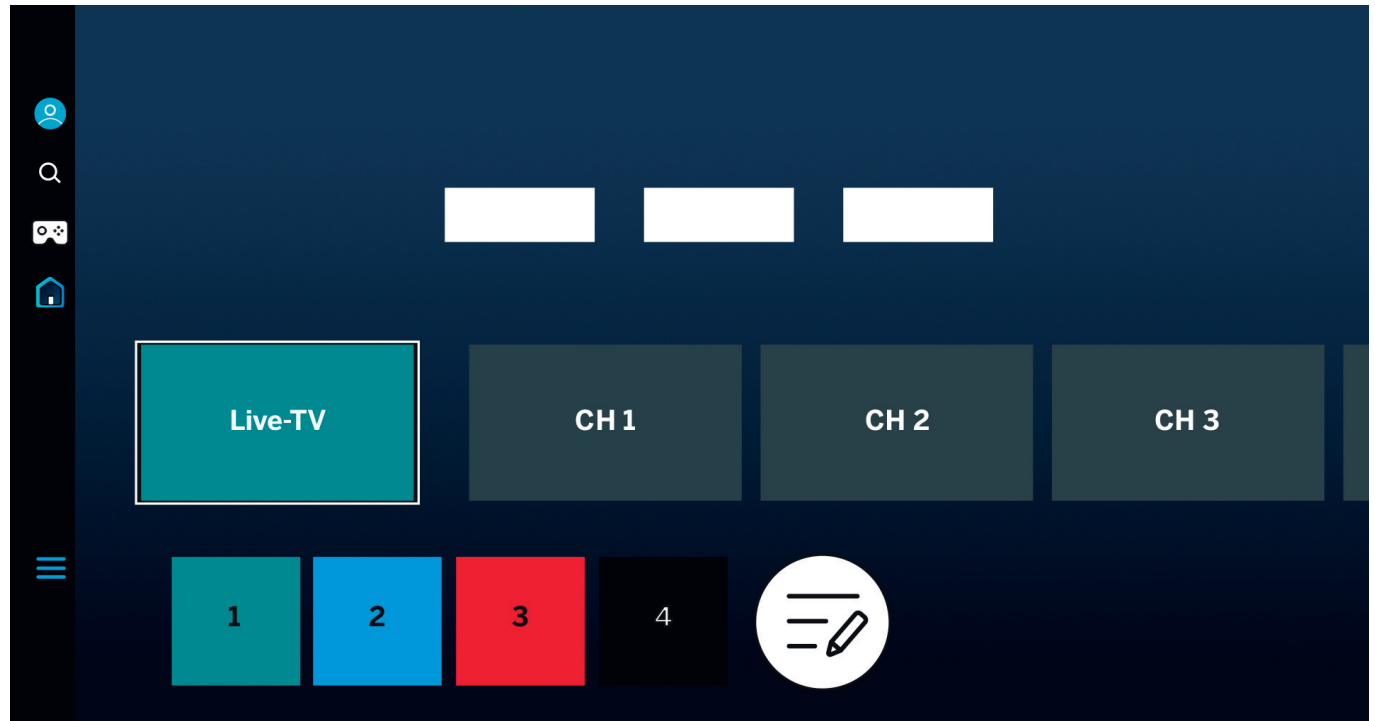

Use the directional keys  to navigate. The highlighted and enlarged tile is currently selected.

Launch installed apps, services, or live TV by pressing the select key . More settings are available on the left: User profile, search, ambient mode, gaming hub, Media, and privacy policy.

 Depending on your country and region, display and information may vary.

At a glance.

# Electronic programme guide.

The electronic programme guide (EPG) provides information about the current and future television programme. You can also use it to schedule recordings.

 Press the guide key on your remote to open the programme guide.

The following options are available to you:

 Edit channel filters.

 Show TV channel only.

 Show radio stations only.

 Edit channels.

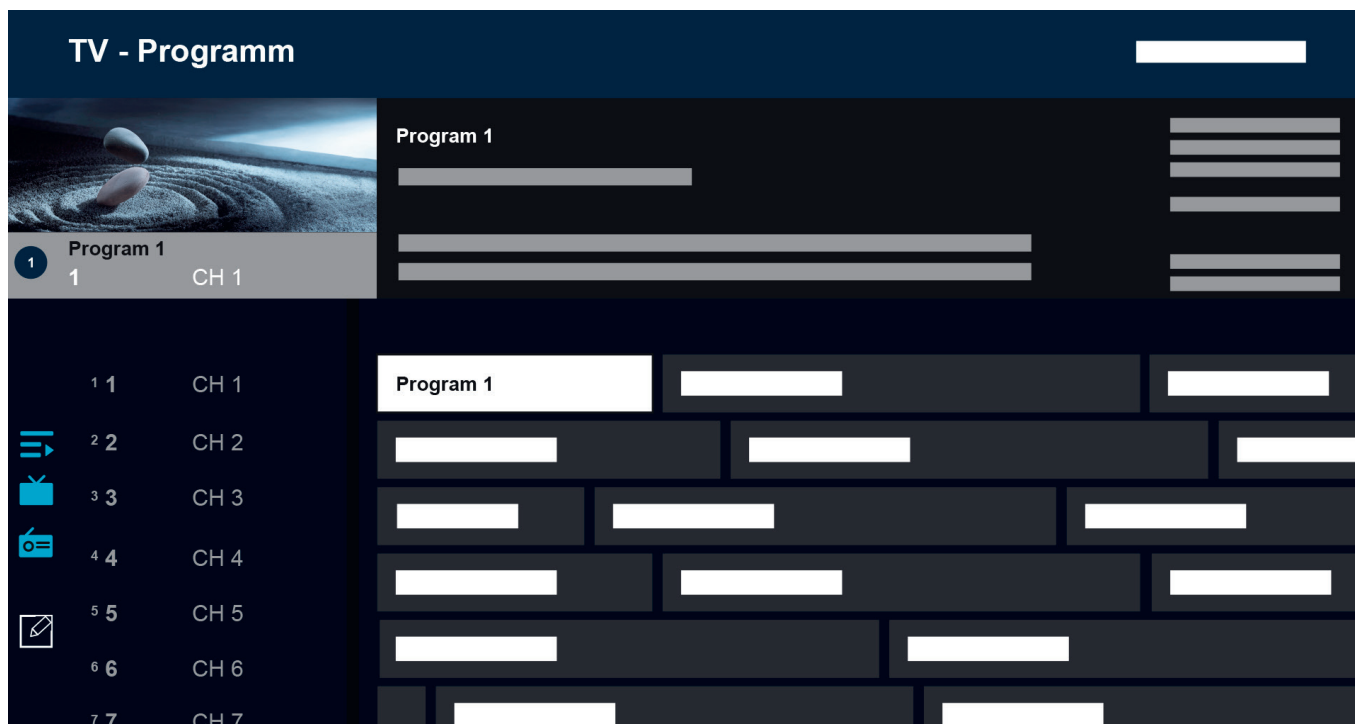

Additional features of the EPG:

- Live image preview.
- Informationen about the current programme.
- Date and time display.
- Preview of all available channels.
- Loewe remote stellar mini overview.

More info available in the Tizen OS eManual.



 Depending on your country and region, display and information may vary.

## Recording with dr+.

# Multi-recording.

Record programmes with Loewe stellar, schedule a recording or use Timeshift to watch a live TV programme later. Recordings are automatically stored on the built-in hard drive. If you like, you can also use a suitable external USB storage device.

## Instant recording.

Select a live TV programme you would like to record and press the recording key  or . Select "Recording 

## Schedule recording.

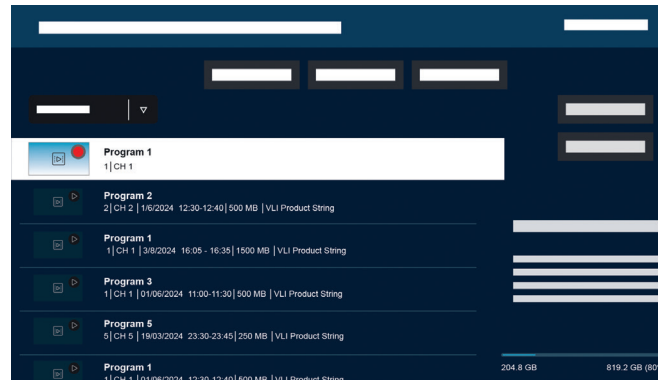

Open the EPG and pick a programme you would like to record. Confirm with  and select "Schedule recording" in the following pop-up menu to start. Manual recordings can be scheduled in the programme manager.



## Recording and programme manager.



The recording and programme manager offers an overview over past and scheduled recordings.

## Recordings.

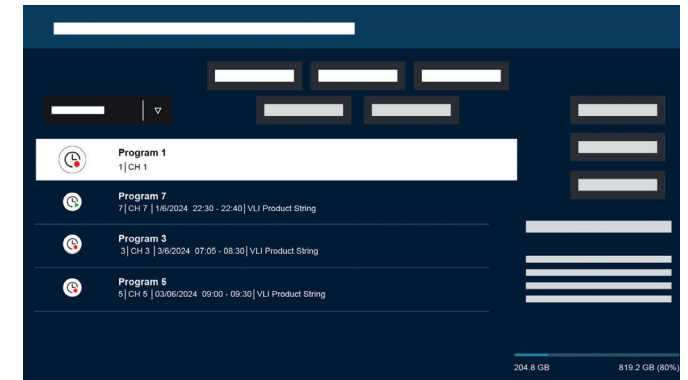
While in live TV mode, open the list of available recordings by pressing  and select . Select the desired recording with the directional keys and confirm with  to play it.



## Scheduling.

While in live TV mode, press  and select  to get an overview of all scheduled recordings. Via the button "Add recording" it is possible to schedule manual, as well as serial recordings.

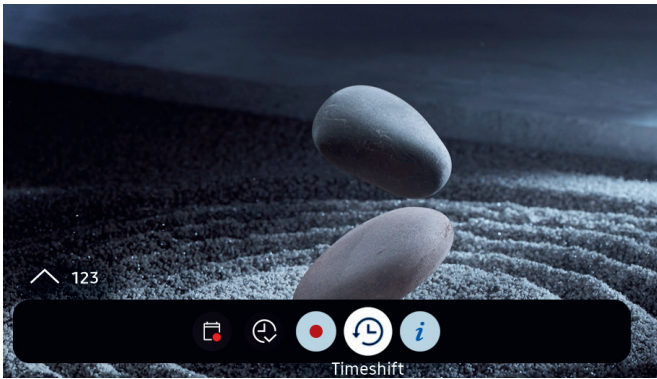

## Timeshift.

Press to activate Timeshift.

With Timeshift active, you can pause a programme and resume watching it later, or even rewatch sections.

Max. recording capacity: 90 minutes.

Press the directional key down to display the progression bar within the Timeshift menu.

Use the directional keys to navigate the Timeshift menu.

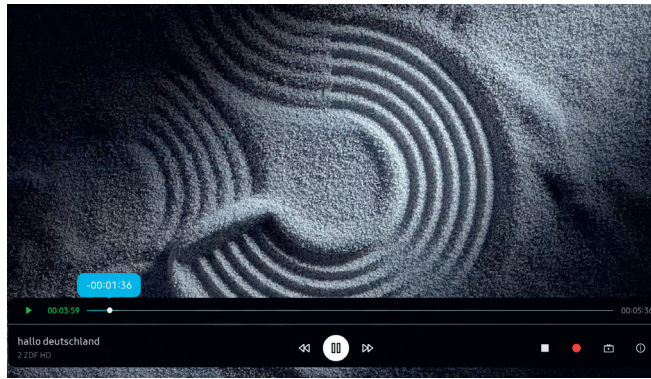

## Timeshift menu:

- Timeshift Play/pause.
- Fast forward.
- Rewind.
- Stop Timeshift.
- Start recording.
- Back to live TV. Timeshift remains active.
- Info.

Please read all safety instructions before using Timeshift, especially the section "Connected USB hard drives". Disconnecting the device from the power supply can lead to data loss.

Further information is available in the eManual, section "Before recording and using Timeshift".



A glowing reception.

# Loewe magic.light

Every Loewe stellar features an integrated Loewe magic.light. Use the discretely hidden LED band for subtle welcome and farewell illuminations or have it underline your favourite movie in a warm white tone.

Customise magic.light according to your wishes and current mood. Learn more about this feature in this section.

 Activate settings:  
Press the magic.light key and confirm with .

 Switch light band on or off.

 Adjust brightness with the directional keys.

 Adjust saturation with the programme keys.



 Adjust colour with the directional keys.





Warm white: 100% saturation  
Cold white: 0% saturation

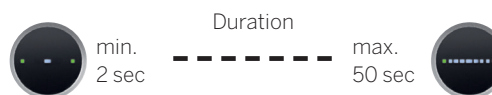

## Adjusting illumination duration.

1. Press and hold the magic.light  and the settings key  simultaneously for five seconds. The Loewe signature.ring will display a line with seven white dots. The number of dots indicates the duration of the illumination:



2. Now you can adjust the duration. The line inside the signature.ring changes, when pressing left and right .
3. Press  to save the configuration.

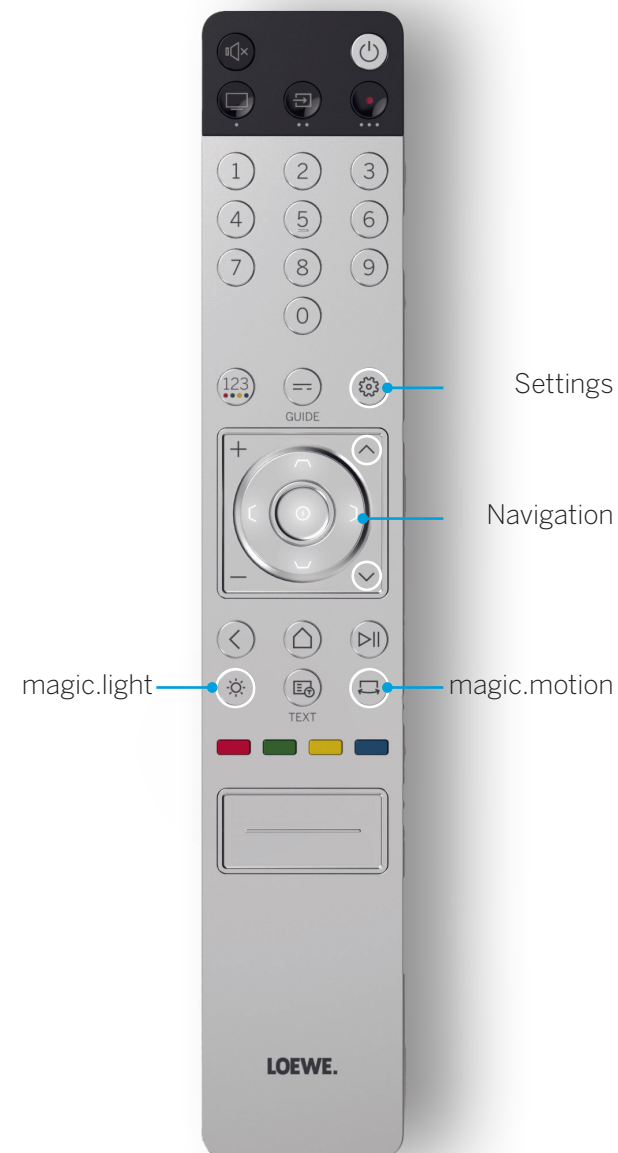

The perfect angle.

# Loewe magic.motion

Through magic.motion, it is possible to rotate the device on the motorised optional Loewe floor stand motor stellar at the push of a button.

The magic.motion key  on your Loewe remote stellar enables this feature.

---



 Press the magic.motion key.

---







 Press the directional keys to rotate the TV. Max. rotation angle: 45°

---

## Setting up rotation.

Simultaneously press the magic.motion  and the settings key  for five seconds. You will hear a short tone. Setup mode is now active.

By pressing the directional keys , you can rotate the TV in either direction.

1. Press and hold the left directional key  to turn the device all the way to the left. Press  to save this position. Now you will hear two short tones.
2. Press and hold the right directional key  to turn the device all the way to the right. Press  to save this position. Now you will hear three short tones.
3. Now press and hold the left directional key again and turn the device back to the desired power off position. Press  to save this position as well. Now you will hear four short tones.
4. Finally, press  again, to confirm that this is the default position when turning the device on and off.
5. Now you will hear a long tone. Setup mode has ended.



Obstacle recognition: magic.motion will stop automatically, when hitting an obstacle.



20 seconds without any input will cancel the set-up.

Good to know.

## Apps and technical information.

### Download the my Loewe app.

Use your smartphone to scan the QR code below and download the recommended app. "my Loewe" is the entry point into the world of Loewe and gives you access to all user manuals for your Loewe products.



### Technical information.

ou've purchased a TV with an OLED screen that meets the highest quality standards and has been checked for pixel defects. Despite the greatest care in the manufacture of the display, it cannot be guaranteed 100% for technical reasons that no subpixel errors will occur. However, as long as these effects are within the limits specified in the standard (ISO 9241-307, defect class II), they are not considered to be equipment defects within the meaning of the warranty. Organic Light Emitting Diodes are an imaging technology based on self-illuminating pixels that offer significant advantages in terms of image quality and performance. Under certain circumstances, persistent one-sided exposure to the OLED material can result in permanent and irreversible image aberrations. Such residual image problems occur when the TV displays static image content such as static images, subtitles, ticker displays, slideshows or video sequences in an infinite loop, static displays on a presentation monitor or video games. Black bars on some screen formats can also lead to residual image problems. It is important to emphasize that these residual image problems do not constitute defects in the sense of warranty. If static images are displayed for too long, the TV automatically

reduces contrast or switches to screen saving mode. The next time the user is operating the device, it immediately returns to its normal state. Under normal display conditions, there are no such residual image problems. In order to maintain the high quality of the image display long term, your Loewe OLED TV calibrates itself at regular intervals.

### Connected USB hard drives.

Disconnecting the TV from the mains during operation or an accidental interruption of the power supply (e.g. power failure) can lead to damage to the hard disk file system and thus to the loss of recorded broadcasts. Never disconnect the USB storage device from the TV. We recommend that you put the TV into standby mode before unplugging it. Loewe does not assume liability for the loss of data stored on your TV's built-in hard drive.

### Software updates.

The latest software versions can be downloaded from the Loewe website (listed below) and installed on your TV using a USB stick. If your TV is connected to the Internet, you can update it directly from the Internet. Further information on software updates can be found in the user manual, which is available for download on the Loewe website. It cannot be guaranteed that Loewe models will permanently work from the outset with all connectable peripherals.

### Digital services disclaimer.

Our TVs are "products with digital elements", whose core functions, such as TV reception via cable or satellite or playing DVDs/Blu-rays via a player connected to the TV set, can in principle also be used without these digital elements. The digital elements available on the device include, but are not limited to, apps, games, music, video services and other programs, as well as platforms that allow you to download and/or access additional apps. The services, contents and/or elements mentioned above, as well as the server platforms required for them, which they access in the background via the Internet, are offered and/or provided by third-party providers. Please note the respective end-user and/or terms and conditions of these third-party providers, which you must accept a later date, in particular when installing the TV set for the first time, but also when using third-party services. This acceptance creates a direct contractual relationship between you and the respective third-party service providers regarding the use of the respective digital elements, services and/or contents. As a TV set manufacturer, Loewe Technology GmbH has no influence on the provision of digital elements, services and contents, their quality, visual presentation, the provision of updates and, in particular, the end of life of these digital elements, services and contents. On the other hand, during the life of the TV, new digital elements, services and/or content may also be offered on the device without your regular consent. These additional digital elements, services and/or content result from, among other things, technological progress and general market requirements. However, there is no obligation to provide new digital elements, services and/or content.

# Declaration.

In particular, there is no obligation to provide a replacement or successor after the end of life of a digital element, service or content. Please refer to the respective end user and/or terms and conditions applicable to your device.



Loewe Technology GmbH confirms that its product complies with the essential requirements of Directive 2014/53/EU, as well as other relevant EU directives.

In the frequency range 5150 to 5350 Mhz, this TV may only be used indoors in the following countries:

Austria, Belgium, Bulgaria, Croatia, Cyprus, Czech Republic, Denmark, Estonia, Finland, France, Germany, Greece, Hungary, Ireland, Italy, Latvia, Lithuania, Luxembourg, Malta, Netherlands, Poland, Portugal, Romania, Slovakia, Slovenia, Spain, Sweden, United Kingdom.

Here you can find the complete declaration of conformity in the product selection:

**[www.loewe.tv/eu/en/service/support](http://www.loewe.tv/eu/en/service/support)**

# Imprint.

Loewe Technology GmbH  
Industriestraße 11  
96317 Kronach, Deutschland  
[www.loewe.tv](http://www.loewe.tv)

Registry court: Frankfurt am Main, HRB 117013  
Represented by: Aslan Khabliev

The information in this document may be subject to change without prior notice. All rights reserved, including translation, technical changes and errors.







# Loewe stellar. Made in Germany.

## Welkom.

Hartelijk dank dat u voor Loewe stellar hebt gekozen. Wij zijn heel blij om u als klant bij ons te mogen verwelkomen. Design, innovatie en geavanceerde technologie – u hebt gekozen voor een apparaat dat al deze kwaliteiten in één topproduct verenigt. Dit OLED TV-model van Loewe fascineert dankzij de modernste weergavetechnologie, krachtige hardware en een nieuwe designtaal.

### De Loewe stellar wordt met zorg gebouwd.

Elk detail van dit product weerspiegelt de toewijding en het vakmanschap waarmee Loewe en diens medewerkers zich al meer dan 100 jaar onderscheiden. Geniet van het unieke verlichtingsconcept van Loewe stellar. Met deze opmerkelijke productlijn wordt elk moment een Magic Moment. Loewe dual-channel dr+ met een triple tuner ontgrendelt een geheel nieuwe tv-ervaring - geniet van Multi View en Multi Recording in onberispelijke kwaliteit.

Voor liefhebbers van gamen biedt de stellar volledige ondersteuning voor HDMI 2.1 en Ultra HD @ 144 Hz VRR, voor een supersnelle, naadloze game-ervaring. Met ons uitgebreide aanbod van streaming-apps en VOD-diensten, op basis van het uitstekende Tizen OS, is er entertainment voor iedereen.

Lees deze instructies zorgvuldig door. Om ervoor te zorgen dat u lang van uw Loewe-product kunt genie-

ten, dient u de veiligheidsinstructies in acht te nemen die afzonderlijk zijn bijgevoegd. Als u vragen hebt of hulp nodig hebt, dan staat het team van het Loewe Customer Care Center altijd voor u klaar.



In deze sectie van de handleiding leest u belangrijke basisinformatie over de installatie van uw Loewe-tv. Na de eerste keer inschakelen leidt een intuïtieve ingebruikstellingsgids u door het installatieproces.

Op de website van Loewe kunt u bovendien een gedetailleerde digitale handleiding downloaden. Hierin staan uitgebreide beschrijvingen van de functies en kenmerken van uw nieuwe Loewe-tv.



[www.loewe.tv](http://www.loewe.tv)

### Inhoudsopgave.

Welkom.	53
Symbolen en typeplaatje.	54
Leveringsomvang.	55
Overzicht - tv.	56
Eerste stappen - Tv-installatie.	58
Overzicht - Afstandsbediening.	60
Eerste stappen - Afstandsbediening.	62
Eerste stappen - Eerste installatie.	64
Startscherm.	68
Elektronische programmagids (EPG).	69
Multi Recording.	70
Loewe magic.light	72
Loewe magic.motion	73
Apps en technische informatie.	74
Verklaring.	75
Colofon	75

Symbolen en hun betekenis.

## Symbolen en typeplaatje.

Deze gebruikershandleiding bevat diverse symbolen, waarvan de betekenis op deze pagina wordt uitgelegd. Lees deze sectie zorgvuldig door en onthoud de betekenis van de diverse symbolen goed.

Het typeplaatje bevat belangrijke informatie over het apparaat:

- Apparaatnaam
- Type apparaat
- Artikelnummer
- Serienummer



Waarschuwingen vestigen de aandacht op zaken die uw gezondheid of leven of de gezondheid of het leven van anderen in gevaar kunnen brengen. Let goed op de waarschuwingen.



Milieumededelingen bevatten informatie over milieubewust handelen of milieubewust afvoeren. Let goed op de milieu-informatie.



Algemene hints en tips in verband met het apparaat of een toepassing van het apparaat.



Elektronicemeldingen vestigen de aandacht op gevaren die, indien genegeerd, het apparaat kunnen beschadigen of uw gezondheid of leven in gevaar kunnen brengen.



Waarschuwingen voor breukgevaar geven aan dat er een risico op schade aan uw apparaat bestaat of dat letsel mogelijk is. Let goed op de waarschuwingen voor breukgevaar.

### Positie van het typeplaatje

Het label met het modelnummer en de bedrijfsspanning vindt u op de achterkant van de tv.

Voorbeeld van een typeplaatje:



#### stellar.65

Ultra HD / OLED / CI+ / DR+

Art.No. 63470 B 10 Ser.No. 00001 / 3463

CH-TYP SL950

220-240V~ 50/60Hz 450 W



**LOEWE.**

Loewe Technology GmbH  
Industriestraße 11  
D-96317 Kronach

Manufactured  
in Germany

Alles wat u nodig hebt.

## Leveringsomvang.

Controleer of alle inhoud van de verpakking en de Loewe-welkomstdoos aanwezig zijn. Als er onverhoopt iets ontbreekt, neem dan contact op met uw dealer of het Loewe Customer Care Center.

### Inhoud.

- Loewe quick start guide
- Gebruiksaanwijzing (dit document)
- Loewe stellar
- Standaard
- Netsnoer
  
- Loewe-welkomstbox
  - Loewe remote stellar
  - Loewe remote stellar mini
  - AAA-batterijen
  - Tabel met technische gegevens over de Loewe stellar
  - Veiligheidsinstructies Loewe OLED
  - Montage-instructies voor de standaard
  - Montageset voor de standaard









Voorkant.

## Overzicht - tv.



① Loewe signature.ring

Led-indicatielampje tv-status

-  Stand-by
-  TV AAN: Paneel AAN
-  TV AAN: Paneel UIT
-  Tv stand-by: OLED-Refresh
-  Opname actief
-  Timeshift actief

② Loewe stellar tafelstandaard\*

③ Loewe magic.light

④ Soundbar

⑤ OLED-scherm

⑥ Kenmerkende Loewe-vlag

\*Afhankelijk van variant en grootte.



## Achterkant.

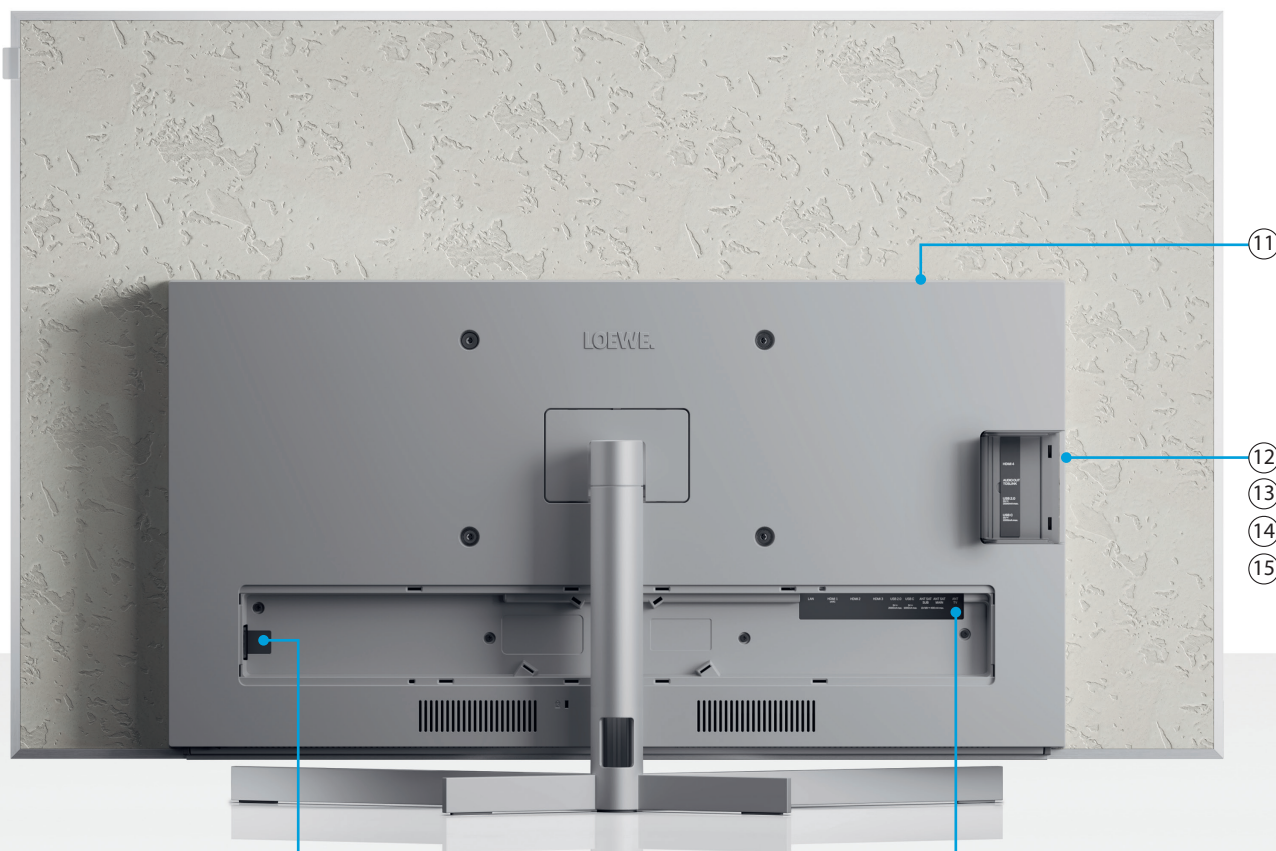

①	AC-IN	Netaansluiting - 220-240 V - 50/60Hz
②	LAN*	Netwerkverbinding RJ-45
③	HDMI 1	HDMI 2.1 met eARC Audio-OUT
④	HDMI 2	HDMI 2.1-ingang
⑤	HDMI 3	HDMI 2.1-ingang
⑥	USB-A	USB 2.0 - 5V $\overline{=}$ , 2000 mA max.
⑥	USB-A	USB 2.0 - 5V $\overline{=}$ , 2000 mA max.
⑦	USB-C	USB 3.1 - 5V $\overline{=}$ , 1000 mA max.
⑧	ANT SAT	Satelliet aansluiting - DVB-S/S2 HD
	SUB	13/18 V, 400 mA
⑨	ANT SAT	Satellietontvanger DVB-S/S2 HD
	MAIN	13/18 V, 400 mA
⑩	ANT TV	Terrestrisch/tv-antenne DVB-C/T/T2 HD
⑪	Common Interface	CI+ V1.4
⑫	HDMI 4	HDMI 2.1-ingang
⑬	Audio Out Toslink	Audio-uitgang 3.5 mm/ TOSLINK
⑭	USB-A	USB 2.0 - 5V $\overline{=}$ , 2000 mA max.
⑮	USB-C	USB 3.1 - 5V $\overline{=}$ , 1000 mA max.

\*Het gebruik van een Cat5 LAN-kabel zonder afscherming wordt aanbevolen.

Uitpakken en aansluiten.

# Eerste stappen - Tv-installatie.



## 1. De tv uit de doos halen.

Als u de tv nog niet uit de doos hebt gehaald, volg dan de eenvoudige stappen in de snelstartgids. Ga verder met stap 2 van deze handleiding nadat u de tv stevig aan de standaard hebt bevestigd.

 Let goed op de veiligheidsinstructies en technische specificaties.

 Deze informatie is noodzakelijk voor een veilige installatie en bediening van de tv.



## 2. De antennekabels aansluiten.

Sluit nu de satelliet- of antennekabel aan. De gelabelde poorten bevinden zich aan de achterkant van de tv. Om de poorten bloot te leggen, verwijdert u voorzichtig de afdekplaatjes. Deze zijn gemakkelijk te verwijderen. U hebt hier geen gereedschap voor nodig.

 Sluit de kabels eerst op de tv aan en vervolgens op het satellietstelsel of de kabelaansluiting. Gebruik de kabelgeleider op de tv en de meegeleverde Loewe-standaard.

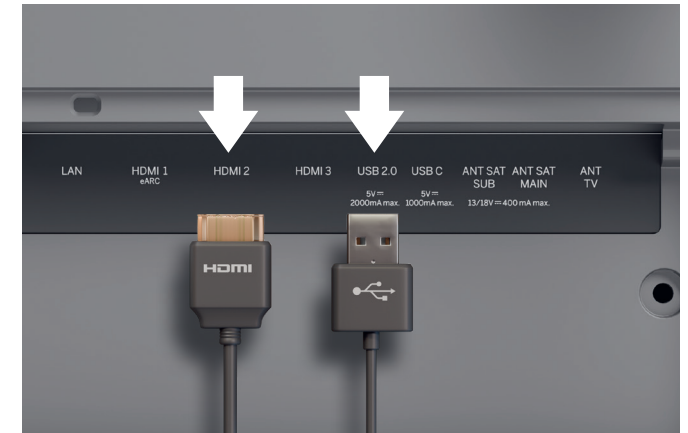

## 3. Extra apparaten aansluiten.

Extra apparaten, zoals gameconsoles of opslagapparaten, kunt u via HDMI en USB aansluiten. Details vindt u op de helppagina's van de digitale handleiding en op de Loewe website.

 Trek de stekkers van alle apparaten uit het stopcontact alvorens u deze aansluit.



#### 4. Netwerk via LAN.

U kunt de tv verbinden met een LAN-netwerk. In de onderstaande sectie "Eerste stappen - eerste installatie" leggen we uit hoe u verbinding tot stand brengt met een wifi-netwerk.

**i** Gebruik een RJ45 CAT7-kabel (10/100 Mbps) om verbinding te maken met een LAN-netwerk.



#### 5. Audio via HDMI eARC.

U kunt een Loewe klangbar of uw geluidssysteem via een HDMI-kabel aansluiten op de tv. Gebruik hiervoor de HDMI 1-poort, die HDMI 2.1 met eARC audio OUT ondersteunt.

**i** Gebruik een HDMI "ultra-high-speed" kabel met type-A connector (niet meegeleverd) voor de best mogelijke videoresolutie en eARC.

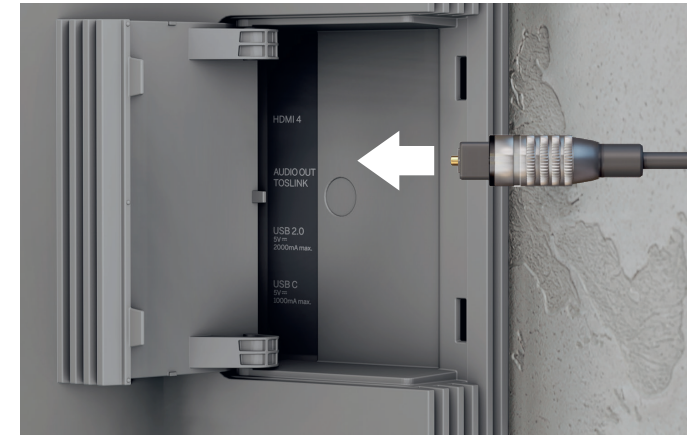

#### 6. Audio: mini-TOSLINK/analooq.

U kunt een audiosysteem via TOSLINK op de tv aansluiten. Het type aansluiting hangt af van uw audiosysteem. Sluit het audiosysteem op de tv aan via de "AUDIO OUT TOSLINK"-uitgang op de tv.

Digitaal: gebruik een optische kabel van mini-TOSLINK naar TOSLINK.

Analoog: Gebruik een adapterkabel (stereo RCA naar jack) om het audiosysteem op de tv aan te sluiten.

Twee voor één.

# Overzicht - Afstandsbediening.

## Loewe remote stellar



**i** Aanvullende functies  
Loewe magic.light  
Loewe magic.motion











	AAN/UIT	Tv IN/UITschakelen
	Dempen	Geluid dempen/geluid inschakelen.
	Tv-modus	Kort indrukken: Live TV, lang indrukken: Overschakelen naar tv-apparaat 1.
	Ingang	Kort indrukken: Apparatenlijst openen, lang indrukken: Overschakelen naar apparaat 2.
	Opnemen	Kort indrukken: Opname starten, lang indrukken: Overschakelen naar apparaat 3.
	Programma	Selecteer kanalen rechtstreeks door op de cijfertoetsen te drukken.
	123-functie	Live TV: opnamemenu, programmamanager, opname, Timeshift.
	Gids	Kort indrukken: EPG openen, lang indrukken: kanaallijst openen.
	Instellingen	Kort indrukken: instellingen openen, lang indrukken: alle instellingen openen.
	Pijltjestoetsen	wijzig het geselecteerde element of de waarde in een menu. Druk op links/rechts/omhoog/omlaag om te navigeren.
	Selecteren	het momenteel geselecteerde element selecteren/starten. Live TV: details voor het huidige programma tonen.
	Volume	het volume verhogen/verlangen.
	Kanaal	Volgende/vorige kanaal.
	Terug	Kort indrukken: terug naar het laatste menu, Live TV: vorige kanaal, lang indrukken: menu sluiten.
	Startscherm	Startscherm openen.
	Afspelen/pauzeren	media afspelen/pauzeren of de Timeshift-modus starten/pauzeren/hervatten.
	magic.light	Instellingen openen voor magic.light. Zie sectie "Loewe magic.light".
	Teletekst	Teletekst en mediatekst openen/sluiten.
	magic.motion	De besturing van magic.motion activeren. Zie sectie "Loewe magic.motion".
	Functie	Menu-afhankelijke functietoetsen.
	Apps	Sneltoetsen om apps en video-on-demand-diensten te starten.

\*optioneel

## Loewe **remote stellar mini**



 Aanvullende functie  
Audio-spraakop-  
drachten

	AAN/UIT	Tv IN/UITschakelen.
	123-functie	Cijfers invoeren en kleuren aanpassen. Live TV: opnamemenu, programmamanager, opname, Timeshift.
	Microfoon	Druk hierop om spraakopdrachten in te schakelen.
	Instellingen	Kort indrukken: instellingen openen.
	Pijltjestoetsen	wijzig het geselecteerde element of de waarde in een menu. Druk op links/rechts/omhoog/omlaag om te navigeren.
	Selecteren	het momenteel geselecteerde element selecteren/starten. Live TV: details voor het huidige programma tonen.
	Terug	Kort indrukken: terug naar het laatste menu, Live TV: vorige programma, lang indrukken: menu sluiten.
	Startscherm	Startscherm openen.
	Afspelen/pauzeren	media afspelen/pauzeren of de Timeshift-modus starten/pauzeren/hervatten.
+/-	Volume	het volume verhogen/verlangen.
^/∨	Kanaal	Volgende/vorige kanaal.
	Video On Demand (VOD)	Sneltoetsen om apps en video-on-demand-diensten te starten.



Batterijen plaatsen en vervangen.

## Eerste stappen - Afstandsbediening.

1. Open het batterijvakdeksel aan de achterkant van de afstandsbediening. Schuif het klepje van het batterijvakje omlaag en til het er vervolgens af. Het batterijvak is nu open.



2. Lijn de eerste batterij uit met de positieve pool zoals aangegeven in de afbeelding op de afstandsbediening.

 Zorg ervoor dat de aansluitingen (+ en -) correct uitgelijnd zijn.

 Controleer of de batterijen stevig vastzitten.

3. Schuif het klepje weer op de afstandsbediening om het batterijvak te sluiten.

Test vervolgens de afstandsbediening om er zeker van te zijn dat deze correct werkt. Als dit niet het geval is, herhaalt u de stappen.





 Voor beide afstandsbedieningen is het plaatsen van de batterijen identiek.

 Gebruik uitsluitend lekvrije AAA LR03-batterijen (alkali-mangaan). U hebt twee batterijen per afstandsbediening nodig.





## De Loewe stellar mini-afstandsbediening koppelen.

Als u de tv voor de eerste keer inschakelt met , dan wordt de tv automatisch verbonden met de Loewe stellar mini-afstandsbediening. Om de afstandsbediening handmatig met de tv te koppelen, richt u de afstandsbediening op de voorkant van de tv. Houd dan de toetsen  en  gelijktijdig gedurende drie seconden inge-



 Het is niet noodzakelijk om de Loewe stellar mini-afstandsbediening te koppelen.

 Houd batterijen buiten het bereik van kinderen. Leg batterijen niet in de zon en gooi ze niet in vuur.

 Voer lege batterijen op milieuvriendelijke wijze af. Raadpleeg voor meer informatie het hoofdstuk Milieu/wettelijke vermeldingen.

drukt.

## De toetseltoetsen programmeren.

Naast de directe functie bieden de tv-toets  en de toetseltoetsen  en  de mogelijkheid om met één druk op de knop andere Loewe-toestellen te bedienen. Met deze functie kunt u andere Loewe-audioapparaten, Blu-ray-spelers en set-topluidsprekers van andere fabrikanten naadloos aansturen. De punten onder elke toets symboliseren de respectievelijke functie.

 Live TV (gedurende 1 sec. indrukken),  
Modus: Loewe tv (gedurende 3 sec. indrukken)

 Ingang (gedurende 1 sec. indrukken),  
Modus: Loewe klang mr 1/3/5 (gedurende 3 sec. indrukken)

 Opnemen (gedurende 3 sec. indrukken),  
Modus: Loewe klang bar 3/5 mr (3 sec press)

## Programmeren naar andere apparaten.

Deze toetsen kunt u ook aan andere apparaten toewijzen. Als u bijvoorbeeld een Blu-ray speler of kabelont-

vanger aan één van de toetsen hebt gekoppeld, dan kunt u het volume en de mute-functie gemakkelijk vanaf de afstandsbediening bedienen. Dit maakt de bediening van uw thuisentertainmentsysteem nóg eenvoudiger en intuïtiever. Meer informatie over het programmeren van de Loewe remote stellar vindt u op de website vna Loewe.

## De ledring activeren en de helderheid aanpassen.



Houd de  toets en één van de cijfer-toetsen 1, 2, 3, 4 of 5 tegelijkertijd drie seconden lang ingedrukt om de helderheid van de leds voor de richtingstoetsen te wijzigen.

"1" komt overeen met de laagste helderheidsinstelling, "5" met de hoogste. Verander de toetsverlichting naar wens.

Snel en gemakkelijk.

## Eerste stappen - Eerste installatie.

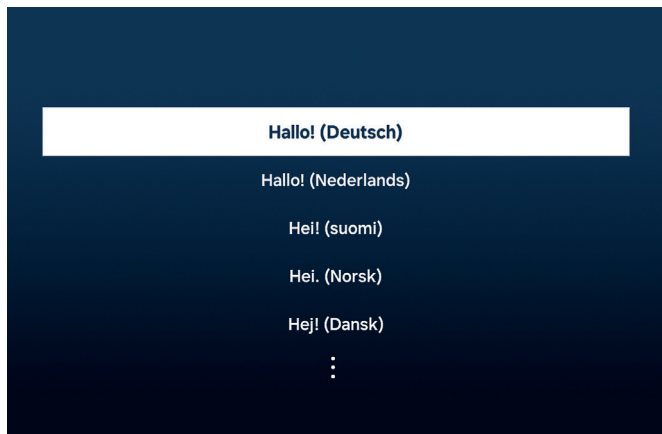

De menutaal selecteren.

Selecteer eerst de gewenste menutaal. Wijzig de taal met de richtingstoetsen . Bevestig met .



De eerste installatie starten.

De Loewe stellar omvat een handleiding voor de eerste installatie. Volg de instructies.

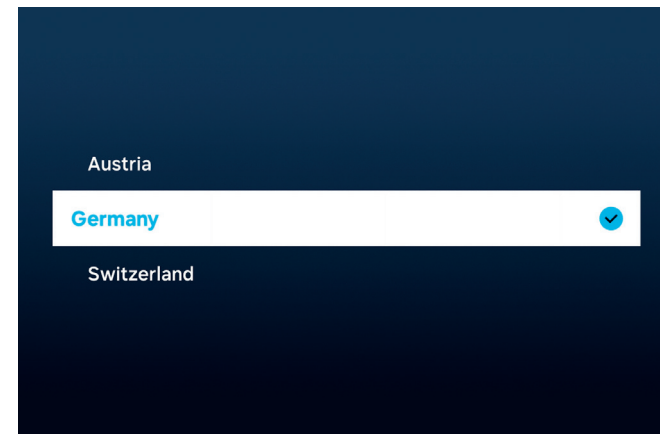

Uw land selecteren.

Selecteer nu uw land of regio met behulp van de richtingstoetsen . Bevestig met .



Let goed op de veiligheidsinstructies en technische specificaties voor deze tv.



Het uiterlijk van de gebruikersinterface kan veranderen na een software-update.

Loewe Customer Care Center  
[www.loewe.tv](http://www.loewe.tv)



Beschikbare services kunnen variëren al naar gelang de geselecteerde regio.

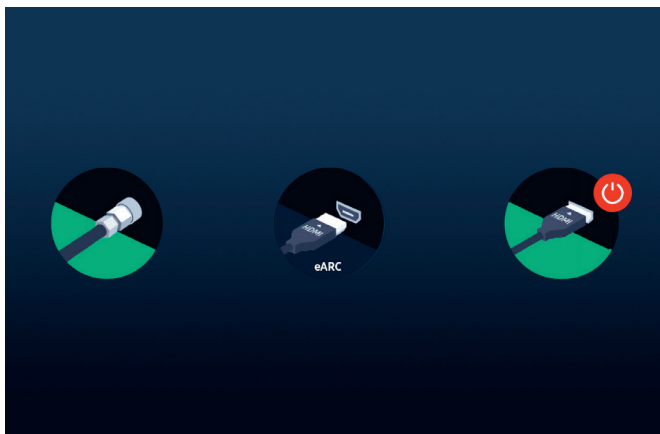

## Automatische-verbindingsherkenning.

Loewe stellar herkent automatisch alle verbonden antennes en apparaten die u via USB of HDMI hebt aangesloten.

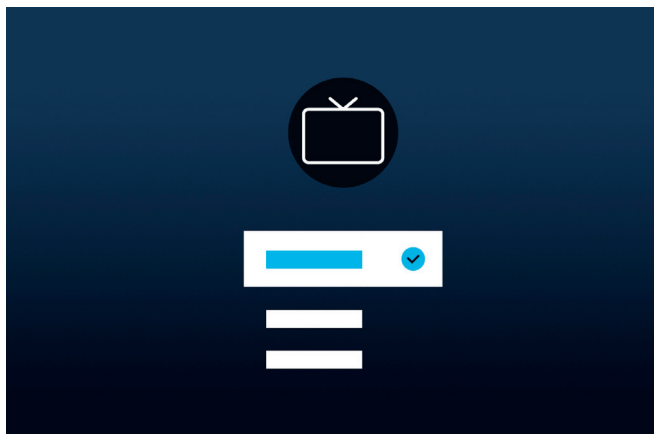

## Tv-ontvangst en programmatype.

Nadat een terrestrisch of kabelsignaal is herkend, selecteert u de tv-ontvangst en het programmatype. In de volgende stap ziet u hoe u alle beschikbare kanalen automatisch kunt opslaan.

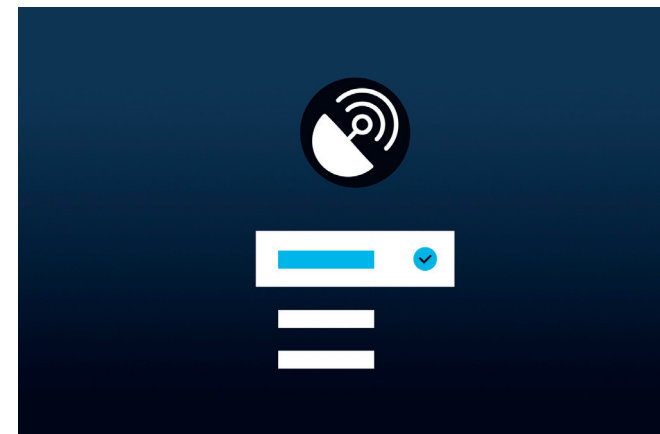

## Satellietsignaal.

Als er een satellietsignaal beschikbaar is, dan kunt u in dit menu fijnafstellingen maken.

Pas het programmatype, de satellietkeuze, de LNB, de satelliet en het zoekbereik aan. Als u SAT MAIN en SAT SUB gebruikt, dan kunt u in dit menu kiezen tussen 'Dual' of 'Main'.

 Controleer of alle apparaten ingeschakeld zijn.

Bijna klaar!

## Eerste stappen - Eerste installatie.

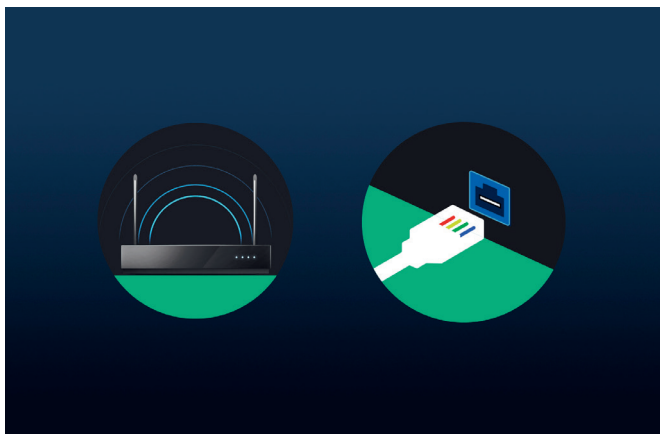

### Een netwerk selecteren.

Om een moderne smart tv optimaal te kunnen gebruiken, is een internetverbinding onmisbaar. U kunt uw Loewe tv via WLAN (draadloos) of LAN (bekabeld) met een netwerk verbinden.

**WLAN** Uitleg in de volgende stap. Houd uw WLAN-inloggegevens bij de hand.

**LAN** Sluit het ene uiteinde van de netwerkkabel aan op uw tv en het andere uiteinde op uw router.

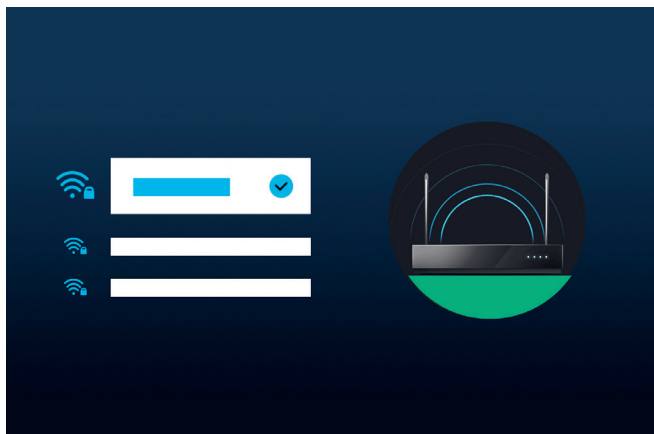

### Verbinding maken met WLAN.

Als u WLAN gebruikt, dan krijgt u nu de vraag om uw wachtwoord in te voeren. Gebruik de richtingstoetsen  en de selectietoets  om cijfers en letters te selecteren. Bevestig met .

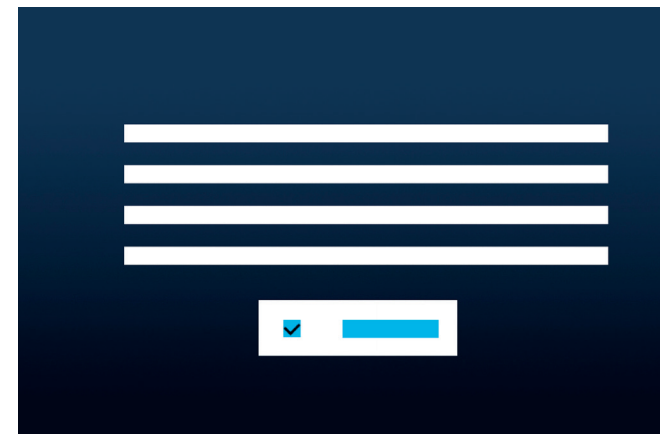

### Algemene voorwaarden, privacy-beleid

Om alle functies van het apparaat te kunnen gebruiken, dient u de algemene voorwaarden en het privacybeleid van Smart Hub te accepteren. Druk op de selectietoets  en klik op "I agree with everything" (Ik ga akkoord met alles) om dit te doen.

Als u ervoor kiest om de algemene voorwaarden en het privacybeleid niet te accepteren, dan kunnen wij de werking van sommige diensten niet garanderen.



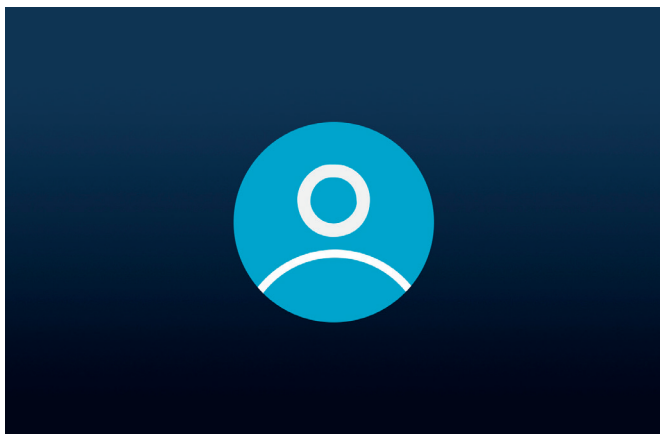

## Een gebruikersaccount aanmaken.

Optionele stap: druk op de richtingstoets  om deze stap over te slaan. Log in op een bestaand Samsung-account of maak een nieuw account aan. Met een Samsung-account profiteert u van de beste functies van uw slimme apparaat en zorgt u dat het altijd up-to-date blijft.

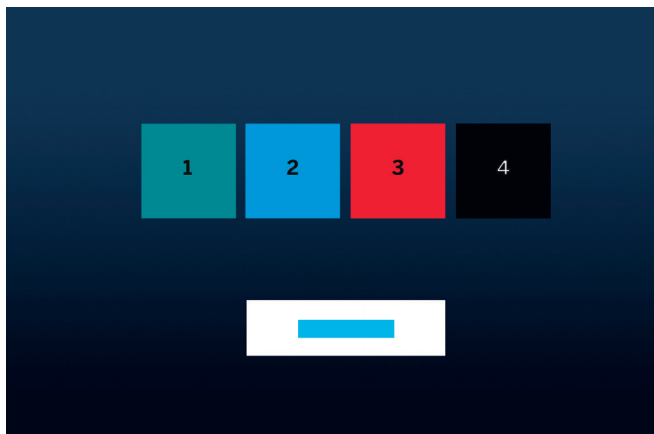

## De taakbalk personaliseren.

In deze stap kunt u apps in de taakbalk opslaan en sorteren. Sommige apps zijn al voorgeïnstalleerd. U kunt de apps later ook aanpassen in de Smart Hub.

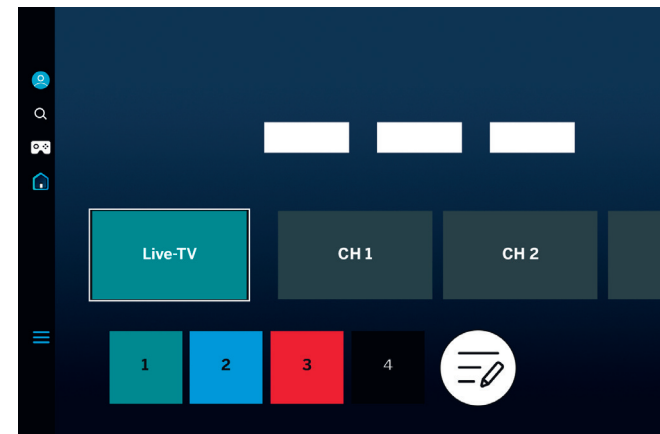

## Startscherf.

Zodra het startscherf verschijnt, is de eerste installatie voltooid. Het is tijd om met uw tv-ervaring te beginnen. Open Live TV of uw favoriete app. Wij wensen u veel plezier met uw nieuwe Loewe tv.

 Een gebruikersaccount is noodzakelijk om apps of Video-On-Demand te gebruiken.

Smart Hub.

# Startscherm.

De Smart Hub vormt het startscherm van uw tv. Van hieruit kunt u apps en diensten openen of Live TV kijken.

 druk op de Home-toets op de afstandsbediening om onmiddellijk naar dit scherm terug te keren.

De volgende opties zijn beschikbaar voor u:

 Gebruikersprofiel: gebruikersprofiel openen.

 Zoeken: kanalen, films of apps zoeken. Spraakopdrachten via de Loewe stellar mini-afstandsbediening.

 Gaming Hub: direct games streamen.

 Startscherm: de app-indeling wijzigen.

 Aangesloten apparaten  / Instellingen 

 Privacy-instellingen wijzigen.

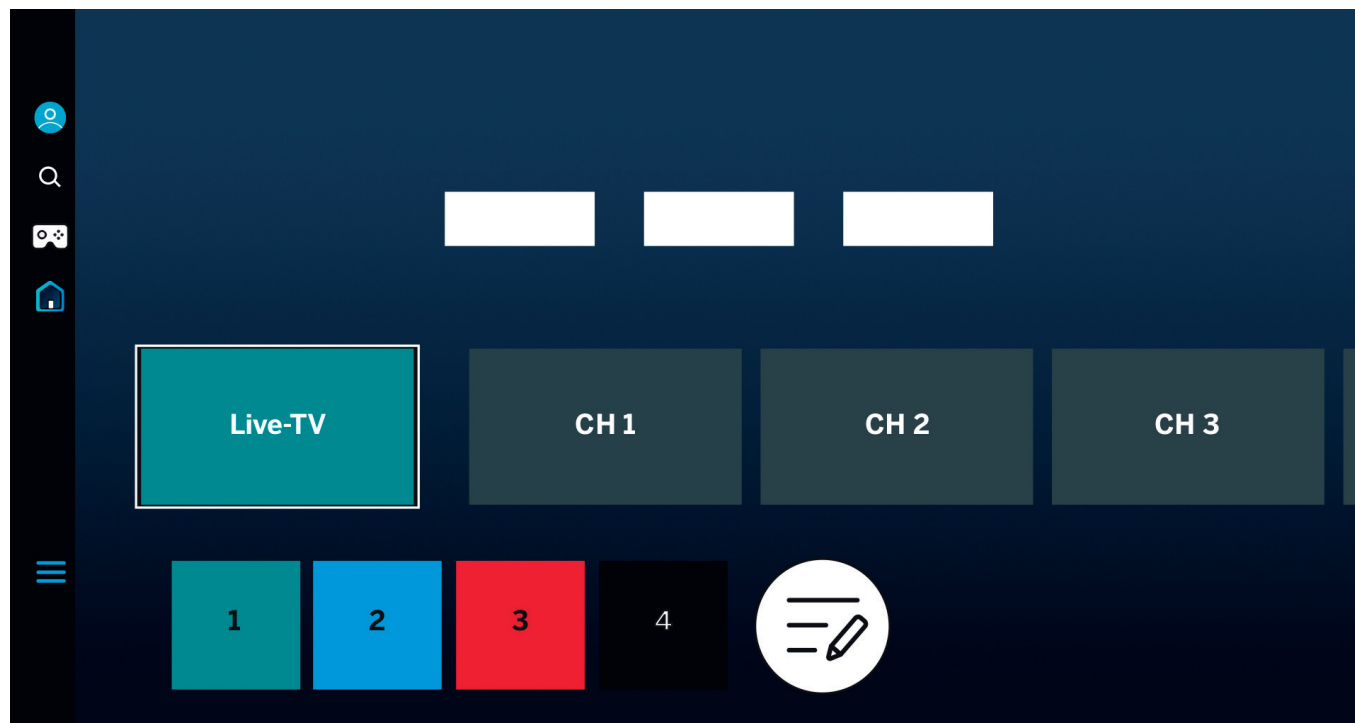

Gebruik de richtingstoetsen  om te navigeren. De gemarkeerde en vergrote tegel is momenteel geselecteerd.

Open geïnstalleerde apps, diensten of Live TV door op de selectietoets  te drukken. Aan de linkerkant vindt u meer instellingen: gebruikersprofiel, zoeken, omgevingsmodus, Gaming Hub, media en privacybeleid.

 Afhankelijk van uw land en regio kunnen het scherm en de informatie verschillen.

In één oogopslag.

## Elektronische programmagids (EPG).

De elektronische programmagids (EPG) geeft informatie over het huidige en toekomstige televisieprogramma's. U kunt de EPG ook gebruiken om opnames te plannen.

 Druk op de gids-toets op uw afstandsbediening om de programmagids te openen.

De volgende opties zijn beschikbaar voor u:

 Kanaalfilters bewerken.

 Alleen tv-kanalen tonen.

 Alleen radiozenders tonen.

 Kanalen bewerken.

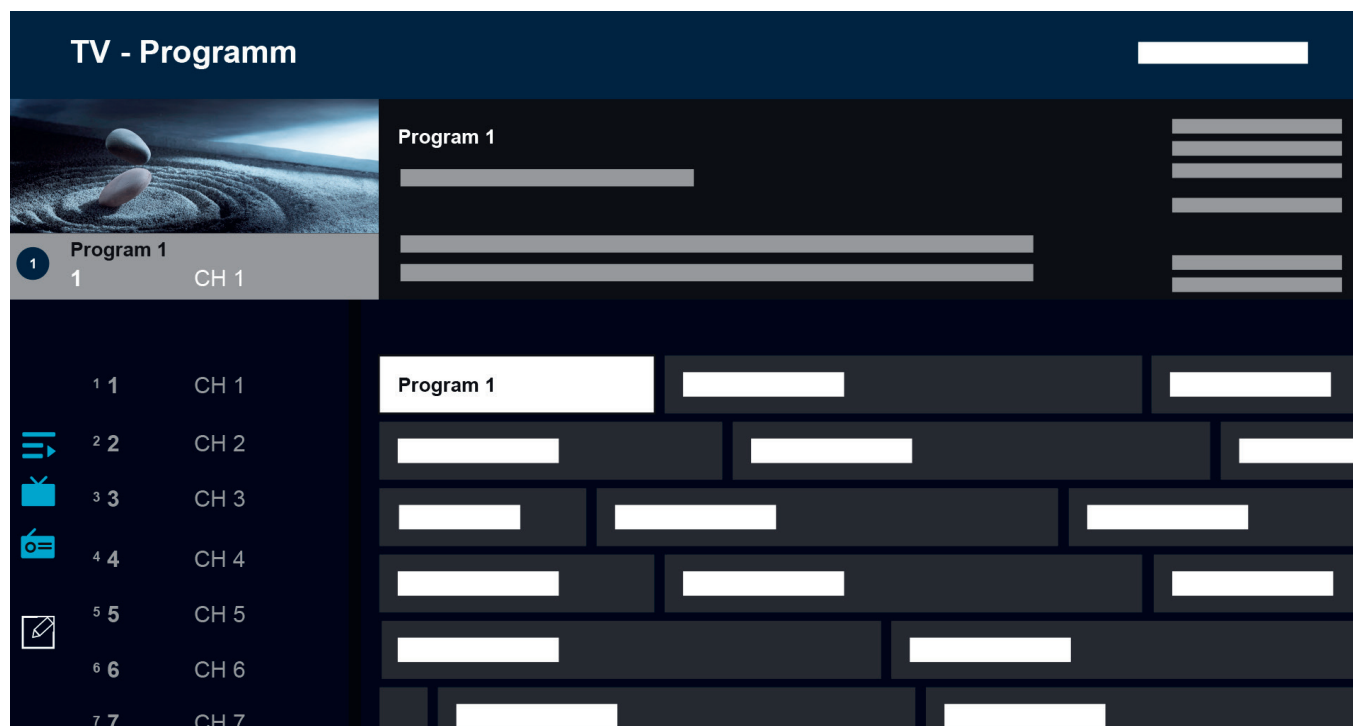

Extra functies van de EPG:

- Voorvertoning van livebeeld.
- Informatie over het huidige programma.
- Weergave van datum en tijd.
- Voorvertoning van alle beschikbare kanalen.
- Overzicht Loewe stellar mini-afstandsbediening.

Meer informatie is beschikbaar in de digitale handleiding van het Tizen OS.



 Afhankelijk van uw land en regio kunnen het scherm en de informatie verschillen.

# Opnemen met dr+.

## Multi Recording.

Neem programma's op met de Loewe stellar, plan een opname of gebruik Timeshift om een Live TV-programma later te bekijken. Opnames worden automatisch opgeslagen op de ingebouwde harde schijf. Als u wilt, kunt u ook een geschikt extern USB-opslagapparaat gebruiken.

### Direct opnemen.

Selecteer een live tv-programma dat u wilt opnemen en druk op de opnametoets  of op . Selecteer "Recording " (Opnemen) in het volgende pop-upmenu om te beginnen.

### Opname inplannen.



Open de EPG en kies het programma dat u wilt opnemen. Bevestig met  en selecteer "Schedule recording" (Opname inplannen) in het volgende pop-upmenu om te starten. U kunt handmatige opnames plannen via de programmamanager.



### Opname- en programmamanager.



De opname- en programmamanager biedt een overzicht van eerdere en geplande opnames.

### Opnemen.

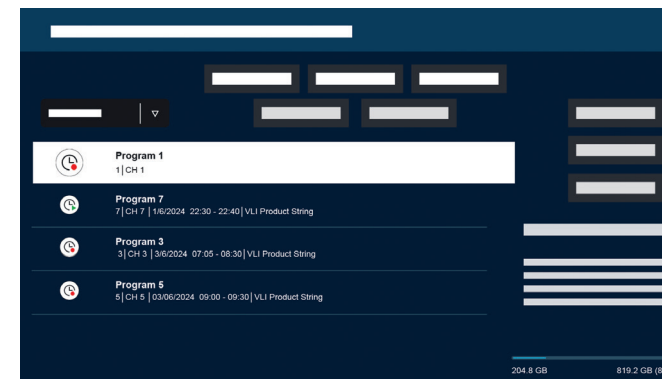
In de Live TV-modus opent u de lijst met beschikbare opnamen door op  te drukken en  te selecteren. Selecteer de gewenste opname met de richtingtoetsen en bevestig met  om deze af te spelen.



### Inplannen.

Druk in de Live TV-modus op  en selecteer  om een overzicht van alle geplande opnames te krijgen. Via de knop "Add recording" (Opname toevoegen) kunt u zowel handmatige als seriële opnames plannen.

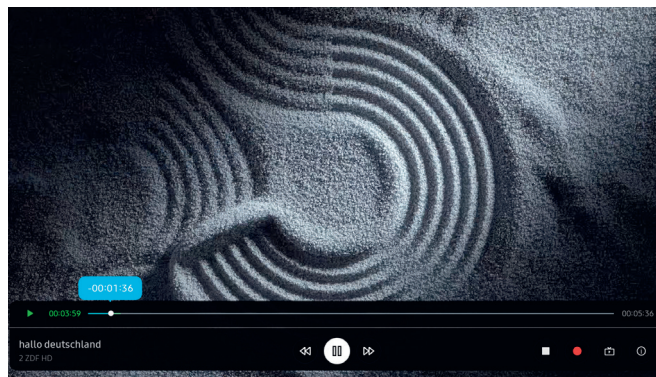
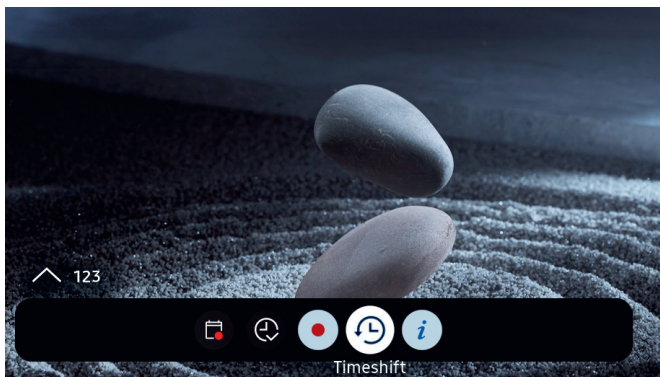

## Timeshift.

Druk op  om Timeshift te activeren.







Als Timeshift actief is, dan kunt u een programma pauzeren en later hervatten of zelfs delen van het programma opnieuw bekijken.

 Max. opnamecapaciteit: 90 minuten.

Druk op de richtingstoets omlaag  om de voortgangsbalk in het Timeshift-menu weer te geven.

Gebruik de richtingstoetsen om door het Timeshift-menu te navigeren.

## Timeshift-menu:

-  Timeshift afspelen/pauzeren.
-  Snel vooruitspoelen.
-  Terugspoelen.
-  Timeshift stoppen.
-  Opname starten.
-  Terug naar Live TV. Timeshift blijft actief.
-  Info.

Lees alle veiligheidsinstructies alvorens u Timeshift gebruikt, met name de sectie "Aangesloten USB-drives". Als u het apparaat loskoppelt van de stroomtoevoer, dan kunt u gegevens kwijtraken.

Meer informatie vindt u in de digitale handleiding in het hoofdstuk "Alvorens u gaat opnemen en Timeshift gebruikt".









Een stralende ontvangst.

# Loewe magic.light

Elke Loewe stellar heeft een geïntegreerde Loewe magic.light. Gebruik de discreet verborgen ledband voor een subtiele welkomst- en afscheidsverlichting of laat hem uw favoriete film met een warmwitte tint vergezellen.

Pas magic.light aan uw wensen en huidige stemming aan. Lees meer over deze functie in deze sectie.

-  Instellingen activeren: druk op de magic.light toets en bevestig met .
-  De lichtband in- of uitschakelen.
-  De helderheid aanpassen met de richtingstoetsen.
-  De verzadiging aanpassen met de programma-toetsen.
-  De kleur aanpassen met de richtingstoetsen.





Warm wit: 100% verzadiging  
Koud wit: 0% verzadiging



## De verlichtingsduur aanpassen.

1. Houd de magic.light  en de instellingentoets  tegelijkertijd gedurende vijf seconden ingedrukt. De Loewe signature.ring toont een lijn met zeven witte stippen. Het aantal stippen geeft de duur van de verlichting aan:



2. Nu kunt u de duur aanpassen. De lijn in de signature.ring verandert wanneer u op links en rechts  drukt.
3. Druk op  om de configuratie op te slaan.

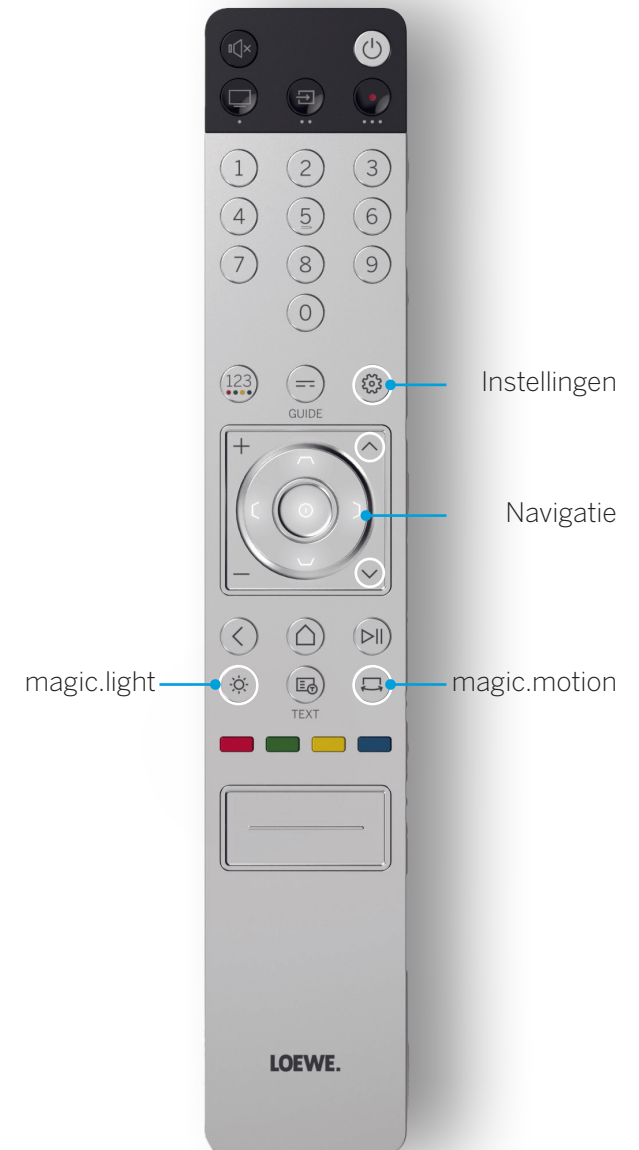

De perfecte hoek.

## Loewe magic.motion

Met magic.motion kunt u om het apparaat op de gemotoriseerde optionele Loewe-vloerstandaard met één druk op de knop draaien.

De magic.motion-toets  op uw Loewe-afstandsbediening maakt deze functie mogelijk.

---



 Druk op de magic.motion-toets.

---

 Druk op de richtingstoetsen om de tv te draaien.  
Max. draaihoek: 45°

---

### Rotatie instellen.

Houd de magic.motion  en de instellingentoets  tegelijkertijd gedurende vijf seconden ingedrukt. U hoort een korte toon. De instelmodus is nu actief.

Door op de richtingstoetsen  te drukken, kunt u de tv in beide richtingen draaien.

1. Houd de linkerrichtingstoets  ingedrukt om het apparaat helemaal naar links te draaien. Druk op  om deze positie op te slaan. U hoort nu twee korte tonen.
2. Houd de rechterraichtingstoets  ingedrukt om het apparaat helemaal naar rechts te draaien. Druk op  om deze positie op te slaan. U hoort nu drie korte tonen.
3. Houd nu de linkerrichtingstoets opnieuw ingedrukt en draai het apparaat terug naar de gewenste uitschakelpositie. Druk op  om ook deze positie op te slaan. U hoort nu vier korte tonen.
4. Druk tot slot nogmaals op  om te bevestigen dat dit de standaardpositie is bij het in- en uitschakelen van het apparaat.
5. U hoort nu een lange toon. De instelmodus is beëindigd.



Obstakelherkenning: magic.motion stopt automatisch wanneer de tv een obstakel raakt.



Na 20 seconden zonder invoer wordt de instelling geannuleerd.

Goed om te weten.

## Apps en technische informatie.

### Download de My Loewe-app.

Gebruik uw smartphone om de onderstaande QR-code te scannen en de aanbevolen app te downloaden. "my Loewe" is het toegangspunt tot de Loewe-wereld en geeft u toegang tot alle gebruiksaanwijzingen van uw Loewe-producten.



### Technische informatie.

U hebt een tv gekocht met een OLED-scherm dat aan de hoogste kwaliteitsnormen voldoet en dat uitgebreid op pixel-defecten is gecontroleerd. Ondanks de grootst mogelijke zorg bij de vervaardiging van het beeldscherm kunnen wij om technische redenen niet 100% garanderen dat er geen sub-pixelfouten optreden. Zolang deze effecten echter binnen de grenzen vallen die in de norm (ISO 9241-307, defectklasse II) zijn gespecificeerd, worden deze niet beschouwd als defecten aan de apparatuur in de zin van de garantie. Het begrip "OLED" (Organic Light Emitting Diode) staat voor een beeldtechnologie op basis van zelfverlichtende beeldpunten, die aanzienlijke voordelen biedt voor wat betreft beeldkwaliteit en performance. Onder bepaalde omstandigheden kan aanhoudende eenzijdige blootstelling aan het OLED-materiaal resulteren in permanente en onomkeerbare beeldafwijkingen. Dergelijke restbeeldproblemen treden op wanneer de tv statische beeldinhoud weergeeft. Denk hierbij bijvoorbeeld aan statische afbeeldingen, ondertitels, tickerweergaven, diavoorstellingen of videosequenties in een oneindige lus, statische weergaven op een presentatiemonitor of videogames. Zwarte balken op

sommige schermformaten kunnen ook leiden tot restbeeldproblemen. Het is belangrijk om te benadrukken dat deze restbeeldproblemen geen defecten zijn in de zin van de garantie. Als er te lang stilstaande beelden worden weergegeven, dan vermindert de tv automatisch het contrast of schakelt over naar de schermbesparingsmodus. De volgende keer dat de gebruiker het apparaat bedient, keert het onmiddellijk terug naar de normale toestand. Onder normale weergaveomstandigheden zijn er geen restbeeldproblemen. Om de hoge kwaliteit van de beeldweergave op lange termijn te behouden, kalibreert uw Loewe OLED-tv zichzelf met regelmatige tussenpozen.

### Aangesloten USB-drives.

Als u de tv tijdens het gebruik loskoppelt van het lichtnet of als de stroomtoevoer per ongeluk wordt onderbroken (bijv. stroomuitval), dan kan het bestandssysteem van de USB-drive beschadigd raken en kunnen opgenomen uitzendingen verloren gaan. Koppel de USB-drive nooit los van de tv. Wij raden u aan om de tv eerst in stand-bymodus te zetten alvorens u de stekker uit het stopcontact haalt. Loewe is niet aansprakelijk voor het verlies van gegevens die zijn opgeslagen op de ingebouwde harde schijf van uw tv.

### Software-updates.

De nieuwste softwareversies kunt u downloaden van Loewe's website (zie hieronder) en via een USB-stick op uw tv installeren. Als uw tv is verbonden met internet, dan kunt u de tv rechtstreeks vanaf het internet bijwerken. Meer informatie

over software-updates vindt u in de gebruikershandleiding, die u kunt downloaden op de website van Loewe. Wij kunnen niet garanderen dat Loewe-modellen vanaf het begin permanent werken met alle aansluitbare randapparatuur.

### Disclaimer voor digitale diensten.

Onze tv's zijn "producten met digitale elementen", waarvan de belangrijkste functies, zoals tv-ontvangst via kabel of satelliet of het afspelen van dvd's/blu-rays via een speler die op de tv is aangesloten, in principe ook zonder deze digitale elementen kunnen worden gebruikt. De digitale elementen die beschikbaar zijn op het apparaat omvatten, maar zijn niet beperkt tot, apps, games, muziek, videodiensten en andere programma's, evenals platforms waarmee u extra apps kunt downloaden en/of openen. De hierboven vermelde diensten, content en/of elementen, evenals de daarvoor vereiste serverplatforms, waartoe zij op de achtergrond via het internet toegang hebben, worden aangeboden en/of geleverd door derden. Wij vragen u om de respectievelijke eindgebruikersvoorwaarden en/of algemene voorwaarden van deze externe aanbieders, die u later dient te accepteren, in het bijzonder wanneer u de tv voor de eerste keer installeert, maar ook wanneer u diensten van derden gebruikt, aandachtig door te lezen. Door aanvaarding van deze voorwaarden ontstaat er een directe contractuele relatie tussen u en de respectievelijke externe dienstverleners met betrekking tot het gebruik van de respectievelijke digitale elementen, diensten en/of content. Loewe Technology GmbH heeft als fabrikant van tv-toestellen geen invloed op de beschikbaarstelling van digitale elementen, diensten en content, de kwaliteit ervan, visuele presentatie, de beschikbaarstelling

# Verklaring.

van updates en in het bijzonder het einde van de levensduur van deze digitale elementen, diensten en content. Anderzijds kunnen er tijdens de levensduur van de tv ook nieuwe digitale elementen, diensten en/of content op het apparaat worden aangeboden zonder uw reguliere toestemming. Deze aanvullende digitale elementen, diensten en/of content vloeien onder meer voort uit technologische vooruitgang en algemene marktvereisten. Er bestaat echter geen verplichting om nieuwe digitale elementen, diensten en/of content te leveren. In het bijzonder bestaat er geen verplichting om een vervanging of opvolger te bieden na het einde van de levensduur van een digitaal element, dienst of content. Raadpleeg de respectievelijke eindgebruikersvoorwaarden en/of algemene voorwaarden die op uw apparaat van toepassing zijn.



Loewe Technology GmbH bevestigt dat zijn product voldoet aan de essentiële vereisten van Richtlijn 2014/53/EU en aan andere relevante EU-richtlijnen.

In het frequentiebereik 5150 tot 5350 Mhz mag deze tv uitsluitend binnenshuis gebruikt worden in de volgende landen:

België, Bulgarije, Cyprus, Denemarken, Duitsland, Estland, Finland, Frankrijk, Griekenland, Hongarije, Ierland, Italië, Kroatië, Letland, Litouwen, Luxemburg, Malta, Nederland, Oostenrijk, Polen, Portugal, Roemenië, Slovenië, Slowakije, Spanje, Tsjechië, Verenigd Koninkrijk, Zweden.

U kunt de volledige conformiteitsverklaring vinden in de productselectie op:

**[www.loewe.tv/eu/en/service/support](http://www.loewe.tv/eu/en/service/support)**

# Colofon

Loewe Technology GmbH  
Industriestraße 11  
96317 Kronach, Duitsland  
[www.loewe.tv](http://www.loewe.tv)

Registratierechtbank: Frankfurt am Main, handelsregister sectie B 117013

Vertegenwoordigd door: Aslan Khabliev

De informatie in dit document kan zonder voorafgaande kennisgeving gewijzigd worden. Alle rechten voorbehouden, met inbegrip van vertalingen, technische wijzigingen en fouten.







# Loewe stellar. Fabriqué en Allemagne.

## Bienvenue.

Merci beaucoup d'avoir choisi Loewe stellar. Nous sommes ravis de vous compter parmi nos clients. Design, innovation et technologie de pointe - vous avez choisi un appareil qui réunit toutes ces qualités dans un produit haut de gamme. Ce modèle de téléviseur OLED de Loewe captive son public grâce à la technologie d'affichage la plus moderne, à un matériel performant et à un nouveau langage de conception.

Loewe stellar est fabriqué en Allemagne.

Chaque détail de ce produit est le reflet du dévouement et du savoir-faire qui distinguent Loewe et ses employés depuis plus de 100 ans. Profitez du concept d'éclairage unique du Loewe stellar et faites de chaque instant un moment magique grâce à cette remarquable ligne de produits. Le Loewe dr+ double canal avec triple tuner offre une nouvelle expérience télévisuelle. Profitez du direct et d'enregistrements multiples avec une qualité irréprochable.

Pour les amateurs de jeux, le stellar offre une prise en charge complète du HDMI 2.1 et de l'Ultra HD à 144 Hz VRR, pour une expérience de jeu super rapide et fluide. Notre gamme complète d'applications de streaming et de services de vidéo à la demande, alimentée par le système d'exploitation premium Tizen OS, garantit un divertissement pour tous.

Veuillez lire attentivement ces instructions. Pour que vous puissiez profiter longtemps de votre produit Loewe, veuillez respecter les consignes de sécurité jointes séparément. Si vous avez des questions ou si vous avez besoin d'aide, le service clientèle de Loewe est toujours à votre disposition.



Dans cette section du manuel d'utilisation, vous trouverez des informations de base importantes sur l'installation de votre téléviseur Loewe. Après la première mise en marche, un guide de mise en service intuitif vous guidera tout au long du processus d'installation.

Un manuel électronique détaillé peut être téléchargé sur le site Internet de Loewe. Il décrit en détail les fonctions et caractéristiques de votre nouveau téléviseur Loewe.



[www.loewe.tv](http://www.loewe.tv)

## Table des matières.

Bienvenue.	77
Pictogrammes et plaque signalétique.	78
Contenu de la livraison.	79
Présentation - Téléviseur.	80
Premiers pas - Installation du téléviseur.	82
Présentation - Télécommande.	84
Premiers pas - Télécommande.	86
Premiers pas - Configuration initiale.	88
Écran d'accueil.	92
Guide électronique des programmes.	93
Enregistrements multiples.	94
Loewe magic.light	96
Loewe magic.motion	97
Applications et informations techniques.	98
Déclaration.	99
Impression.	99

Les pictogrammes et leur signification.

## Pictogrammes et plaque signalétique.

Ce manuel d'utilisation comporte de nombreux pictogrammes dont la signification est expliquée sur cette page. Lisez attentivement cette section et notez leur signification.

La plaque signalétique contient des informations importantes sur l'appareil :

- Nom de l'appareil
- Type d'appareil
- Numéro de l'article
- Numéro de série



Les avertissements attirent l'attention sur des questions qui peuvent mettre en danger votre santé ou votre vie, ou la santé ou la vie d'autrui. Prêtez attention aux avertissements.



Les avis environnementaux contiennent des informations sur les actions ou les éliminations respectueuses de l'environnement. Prêtez attention aux informations relatives à l'environnement.



Conseils généraux en rapport avec l'appareil ou une application de l'appareil.



Les notices électroniques attirent l'attention sur des dangers qui, s'ils sont ignorés, peuvent endommager l'appareil ou mettre en danger votre santé ou votre vie.



Les avertissements de risque de bris indiquent que votre appareil risque d'être endommagé ou que des blessures sont possibles. Faites attention aux avertissements concernant les risques de bris.

Position de la plaque signalétique.

La plaque signalétique indiquant le numéro de modèle et la tension d'alimentation se trouve à l'arrière du téléviseur.

Exemple de plaque signalétique :



**stellar.65**

Ultra HD / OLED / CI+ / DR+

Art.No. 63470 B 10 Ser.No. 00001 / 3463

CH-TYP SL950

220-240V~ 50/60Hz 450 W



**LOEWE.**

Loewe Technology GmbH  
Industriestraße 11  
D-96317 Kronach

Manufactured  
in Germany

Tout ce dont vous avez besoin.

## Contenu de la livraison.

Assurez-vous que tout le contenu de l'emballage et du coffret de bienvenue Loewe est présent. S'il manque quelque chose, veuillez contacter votre revendeur ou le service clientèle de Loewe.

### Table des matières.

- Loewe quick start guide
- Manuel de l'utilisateur (ce document)
- Loewe stellar
- Support
- Cordon d'alimentation
  
- Coffret de bienvenue Loewe
  - Loewe remote stellar
  - Loewe remote stellar mini
  - Piles de type AAA
  - Tableau des données techniques stellar
  - Instructions de sécurité OLED de Loewe
  - Instructions d'assemblage du support
  - Kit de montage pour le support



Avant.







# Présentation - Téléviseur.



- ① Signature.ring de Loewe

---

- Voyant d'état du téléviseur

  -  Veille
  -  Téléviseur en marche : Panneau en marche
  -  Téléviseur en marche : Panneau à l'arrêt
  -  Téléviseur en veille : Rafraîchissement OLED
  -  Enregistrement actif
  -  Timeshift actif

---

- ② Support pour table Loewe stellar \*

---

- ③ Loewe magic.light

---

- ④ Barre de son

---

- ⑤ Écran OLED

---

- ⑥ Signature.flag de Loewe

\*En fonction du modèle et de la taille.



Arrière.



①	AC-IN	Prise secteur - 220-240 V - 50/60 Hz
②	Réseau local filaire*	Connexion réseau RJ-45
③	HDMI 1	HDMI 2.1 avec sortie audio eARC
④	HDMI 2	Entrée HDMI 2.1
⑤	HDMI 3	Entrée HDMI 2.1
⑥	USB-A	USB 2.0 - 5 V $\overline{\text{=}}$ , 2 000 mA maxi.
⑥	USB-A	USB 2.0 - 5 V $\overline{\text{=}}$ , 2 000 mA maxi.
⑦	USB-C	USB 3.1 - 5 V $\overline{\text{=}}$ , 1 000 mA maxi.
⑧	ANT SAT	Prise jack satellite - DVB-S/S2 HD
	SUB	13/18 V, 400 mA
⑨	ANT SAT	Réception satellite DVB-S/S2 HD
⑬	SECTEUR	13/18 V, 400 mA
⑭		
⑮		
⑩	ANT TV	Antenne TV terrestre/TV DVB-C/T/T2 HD
⑪	Common Interface	CI+ V1.4
⑫	HDMI 4	Entrée HDMI 2.1
⑬	Toslink sortie audio	Jack sortie audio 3,5 mm/ TOSLINK
⑭	USB-A	USB 2.0 - 5 V $\overline{\text{=}}$ , 2 000 mA maxi.
⑮	USB-C	USB 3.1 - 5 V $\overline{\text{=}}$ , 1 000 mA maxi.

\*L'utilisation d'un câble LAN Cat5 sans blindage est recommandée.

Déballage et connexion.

# Premiers pas - Installation du téléviseur.

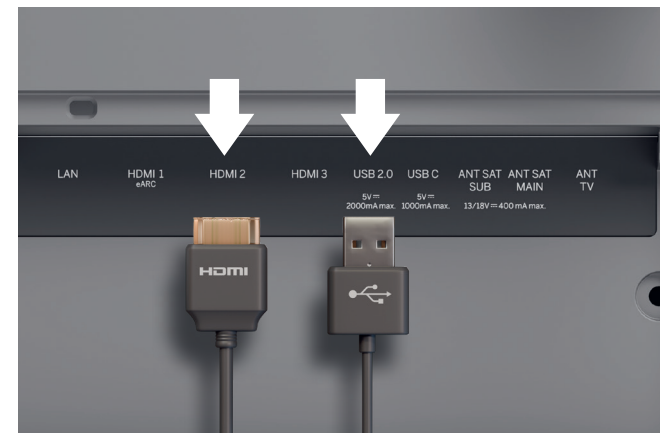

## 1. Déballage du téléviseur.

Si vous n'avez pas encore déballé votre téléviseur, suivez les étapes simples du guide de démarrage rapide. Passez à l'étape 2 de ce guide, une fois que vous avez solidement fixé le téléviseur au support.

 Respectez les consignes de sécurité et les caractéristiques techniques.

 Ces informations sont nécessaires pour installer et utiliser le téléviseur en toute sécurité.

## 2. Raccordement des câbles d'antenne.

Branchez maintenant le câble du satellite ou de l'antenne. Les ports étiquetés sont situés à l'arrière du téléviseur. Pour exposer les ports, retirez soigneusement les couvercles. Ils se retirent facilement. Aucun outil n'est nécessaire.

 Connectez d'abord les câbles au téléviseur, puis au système satellite ou à la connexion par câble. Utilisez le guide-câble sur le téléviseur et le support Loewe fourni.

## 3. Connexion d'appareils supplémentaires.

Des appareils supplémentaires, tels que des consoles de jeux ou des dispositifs de stockage, peuvent être connectés via HDMI et USB. Les détails sont disponibles sur les pages d'aide du manuel électronique et sur le site Internet de Loewe.

 Débranchez tous les appareils du réseau électrique avant de les connecter.



#### 4. Réseau via LAN.

Vous pouvez connecter le téléviseur à un réseau LAN. La connexion à un réseau Wi-Fi est expliquée dans la section « Premiers pas - configuration initiale » ci-dessous.

**i** Utilisez un câble RJ45 CAT7 (10/100 Mbps) pour vous connecter à un réseau LAN.



#### 5. Audio via HDMI eARC.

Vous pouvez raccorder une barre Loewe klang ou votre système audio au téléviseur via un câble HDMI. Pour ce faire, utilisez le port HDMI 1, qui prend en charge HDMI 2.1 avec sortie audio eARC.

**i** Utilisez un câble HDMI « ultra-haute vitesse », connecteur de type A (non fourni), pour obtenir la meilleure résolution vidéo et le meilleur eARC.

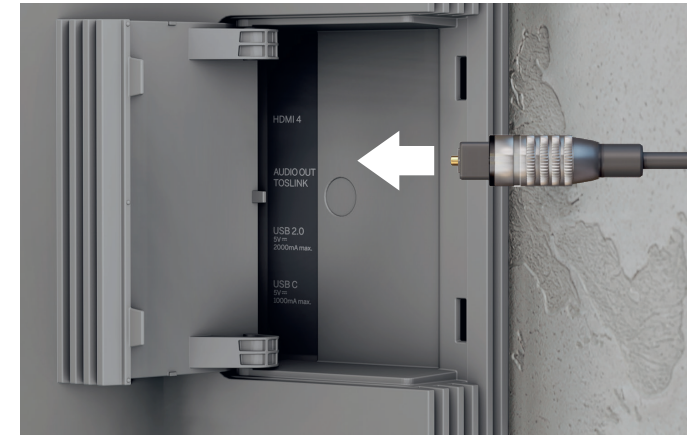

#### 6. Audio : Mini-TOSLINK/analogique.

Vous pouvez connecter un système audio via TOSLINK au téléviseur. Le type de connexion dépend de votre système audio. Connectez la sortie « AUDIO OUT TOSLINK » du téléviseur au système audio.

Numérique : Utilisez un câble optique mini-TOSLINK vers TOSLINK.

Analogique : Utilisez un câble adaptateur stéréo RCA vers jack pour connecter le système audio au téléviseur.

Deux pour le prix d'une.

# Présentation - Télécommande.

## Loewe remote stellar



Caractéristiques supplémentaires  
Loewe magic.light  
Loewe magic.motion

	MARCHE/ARRÊT	Allumer/éteindre le téléviseur
	Sourdine	Couper ou rétablir le son.
	TV-mode	Brève pression : Télévision en direct, pression longue : Passer à l'appareil 1 du téléviseur.
	Entrée	Brève pression : Ouvrir la liste des appareils, pression longue : Passer à l'appareil 2.
	Enregistrement	Brève pression : Démarrer l'enregistrement, pression longue : Passer à l'appareil 3.
	Programme	Sélectionner directement les chaînes en appuyant sur les touches numériques.
	123-Fonction	TV en direct : Menu d'enregistrement, gestionnaire de programmes, enregistrement, Timeshift.
	Guide	Brève pression : Ouvrir l'EPG, pression longue : Ouvrir la liste des chaînes.
	Paramètres	Brève pression : Ouvrir les paramètres, pression longue : Ouvrir tous les paramètres.
	Touches de direction	Modifier l'élément sélectionné ou la valeur sélectionnée dans un menu. Appuyez sur les touches gauche/droite/haut/bas pour naviguer.
	Sélectionner	Sélectionner/lancer l'élément actuellement sélectionné. TV en direct : Afficher les détails du programme en cours.
	Volume	Augmenter/diminuer le volume.
	Chaîne	Chaîne suivante/précédente.
	Retour	Brève pression : Retour au dernier menu, télévision en direct : Chaîne précédente, longue pression : Fermer le menu.
	Écran d'accueil	Ouvrir l'écran d'accueil.
	Lecture/pause	Lecture/pause d'un média ou lecture/pause/poursuite du Timeshift.
	magic.light	Ouvrir les paramètres pour magic.light. Voir la section « Magic.light de Loewe ».
	Télétexte	Ouvrir/fermer le télétexte et le médiatexte.
	magic.motion	Activer le contrôle moteur de magic.motion. Voir la section « Magic.motion de Loewe ».
	Fonction	Touches de fonction dépendant du menu.
	Applications	Touches de raccourci pour démarrer les applications et les services de vidéo à la demande.

\*facultatif



## Loewe **remote stellar mini**



Caractéristique  
supplémentaire  
Commandes vocales

	MARCHE/ARRÊT	Allumer/éteindre le téléviseur.
	123-Fonction	Saisie des chiffres et changement de couleurs. TV en direct : Menu d'enregistrement, gestionnaire de programmes, enregistrement, Timeshift.
	Microphone	Appuyez sur cette touche pour activer la commande vocale.
	Paramètres	Brève pression : Ouvrir les paramètres.
	Touches de direction	Modifier l'élément sélectionné ou la valeur sélectionnée dans un menu. Appuyez sur les touches gauche/droite/haut/bas pour naviguer.
	Sélectionner	Sélectionner/lancer l'élément actuellement sélectionné. TV en direct : Afficher les détails du programme en cours.
	Retour	Brève pression : Retour au dernier menu, télévision en direct : Programme précédent, pression longue : Fermer le menu.
	Écran d'accueil	Ouvrir l'écran d'accueil.
	Lecture/pause	Lecture/pause d'un média ou lecture/pause/poursuite du Timeshift.
	Volume	Augmenter/diminuer le volume.
	Chaîne	Chaîne suivante/précédente.
	Vidéo à la demande	Touches de raccourci pour démarrer les applications et les services de vidéo à la demande.

Insérer et changer les piles.

## Premiers pas - Télécommande.

1. Ouvrez le compartiment des piles à l'arrière de la télécommande. Faites glisser le couvercle du compartiment des piles vers le bas, puis retirez-le. Le compartiment des piles est maintenant exposé.



2. Alignez la première pile avec la borne positive comme indiqué sur l'image dans la télécommande.

 Assurez-vous que les bornes (+ et -) sont correctement alignées.

 Vérifiez que les piles sont bien maintenues.

3. Remettez le couvercle en place et fermez le compartiment des piles.

Testez maintenant la télécommande pour vous assurer qu'elle fonctionne correctement. Si ce n'est pas le cas, répétez les étapes.





 L'insertion des piles fonctionne de la même manière pour les deux télécommandes.

 Utilisez uniquement des piles AAA LR03 (alcalines au manganèse) étanches. Il faut deux piles par télécommande.





## Jumeler la télécommande Loewe stellar mini.

Lorsque vous allumez  le téléviseur pour la première fois, il se connecte automatiquement à la télécommande Loewe stellar mini. Pour jumeler manuellement la télécommande avec le téléviseur, pointez-la vers l'avant du téléviseur et appuyez simultanément sur les touches  et  pendant trois secondes.









 Il n'est pas nécessaire de jumeler la télécommande Loewe.

 Tenez les piles hors de portée des enfants. Ne placez pas les piles au soleil et ne les jetez pas au feu.

 Les piles vides doivent être éliminées dans le respect de l'environnement. Pour plus d'informations, veuillez vous référer au chapitre Environnement/Informations légales.

## Programmation des boutons de l'appareil.

Outre les fonctions directes, la touche TV  ainsi que les touches d'appareil  et  offrent également la possibilité de commander d'autres appareils Loewe par simple pression d'une touche. Cette fonction permet de commander en toute transparence d'autres appareils audio Loewe, des lecteurs Blu-ray et des haut-parleurs d'autres fabricants. Les points situés sous chaque touche symbolisent la fonction correspondante.

-  TV en direct (pression de 1 s),  
Mode : Téléviseur Loewe (pression de 3 s)
-  Entrée (pression de 1 seconde),  
Mode : Loewe klang mr 1/3/5 (pression de 3 s)
-  Recording (3 sec press),  
Mode : Loewe klang mr 3/5 (pression de 3 s)

## Programmation pour d'autres appareils.

Ces touches peuvent également être affectées à d'autres appareils. Par exemple, si un lecteur Blu-ray ou

un décodeur de chaînes du câble est jumelé à l'une des touches, vous pouvez facilement contrôler le volume et la mise en sourdine à partir de la télécommande. L'utilisation de votre système de divertissement à domicile est ainsi encore plus facile et plus intuitive. Vous trouverez de plus amples informations sur la programmation de la télécommande Loewe sur le site Internet de Loewe.

## Activer l'anneau LED et régler la luminosité.



Appuyez simultanément sur la touche  et sur l'une des touches numériques 1, 2, 3, 4 ou 5 pendant trois secondes pour modifier la luminosité des diodes des touches directionnelles.

« 1 » correspond au réglage de luminosité le plus faible, « 5 » au réglage le plus élevé. Modifiez l'éclairage des touches selon vos préférences.

Rapide et facile.

## Premiers pas - Configuration initiale.

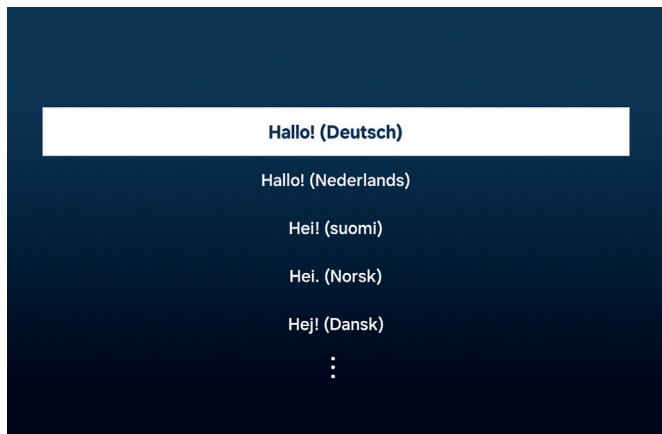

### Sélection de la langue du menu.

Tout d'abord, sélectionnez la langue du menu. Changez de langue à l'aide des touches directionnelles . Confirmez avec .



### Démarrage de la configuration initiale.

Loewe stellar propose un guide pour la configuration initiale. Suivez ses instructions.

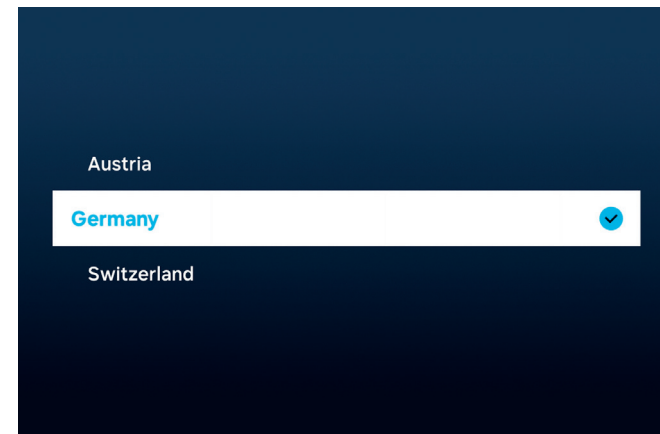

### Sélectionnez votre pays.

Maintenant, sélectionnez votre pays ou votre région à l'aide des touches directionnelles . Confirmez avec .



Respectez les consignes de sécurité et les caractéristiques techniques de ce téléviseur.



L'apparence de l'interface utilisateur peut changer après une mise à jour du logiciel.

Centre d'assistance à la clientèle  
Loewe  
[www.loewe.tv](http://www.loewe.tv)

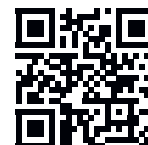

Les services disponibles peuvent varier en fonction de la région sélectionnée.



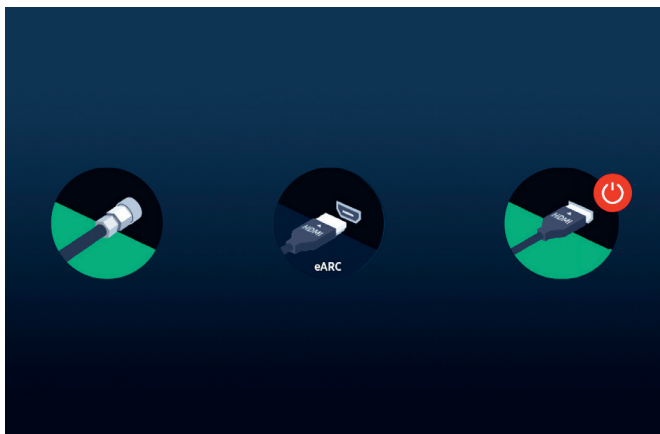

## Reconnaissance automatique des connexions.

Loewe stellar reconnaît automatiquement toutes les antennes et tous les appareils connectés via USB ou HDMI.

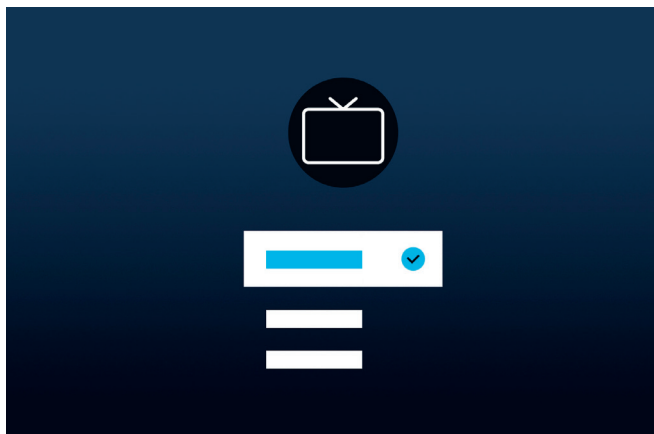

## Réception TV et type de programme.

Une fois qu'un signal terrestre ou câblé a été reconnu, sélectionnez la réception TV et le type de programme. À l'étape suivante, tous les canaux disponibles seront sauvegardés automatiquement.

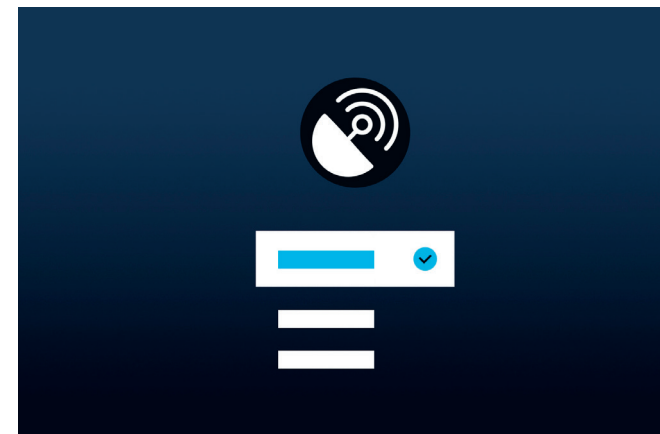

## Signal satellite.

Si un signal satellite est disponible, vous pouvez effectuer des réglages précis dans ce menu.

Régler le type de programme, la sélection du satellite, le LNB, le satellite et la plage de recherche. Lorsque vous utilisez SAT MAIN et SAT SUB, vous pouvez choisir entre dual et main dans ce menu.

 Vérifiez que tous les appareils sont allumés.

Vous avez presque terminé.

## Premiers pas - Configuration initiale.

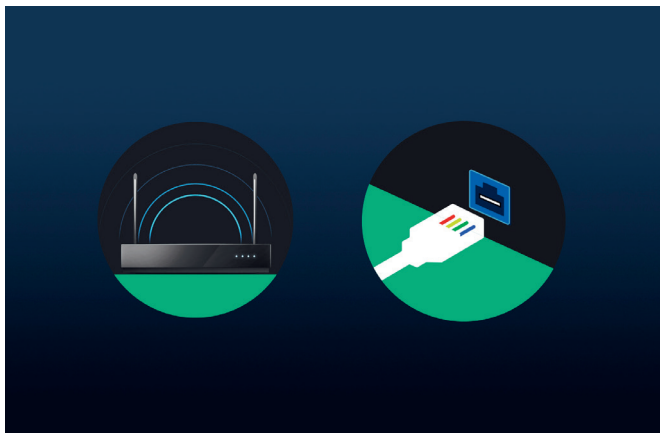

### Sélection d'un réseau.

Pour exploiter pleinement le potentiel de votre téléviseur intelligent moderne, une connexion Internet est nécessaire. Vous pouvez connecter votre téléviseur Loewe à un réseau via WLAN (sans fil) ou LAN (câblé).

Réseau local sans fil : Explication à l'étape suivante. Préparez vos informations d'identification pour le réseau local sans fil.

Réseau local filaire : Assurez-vous que l'une des extrémités du câble réseau est connectée à votre téléviseur et l'autre à votre routeur.

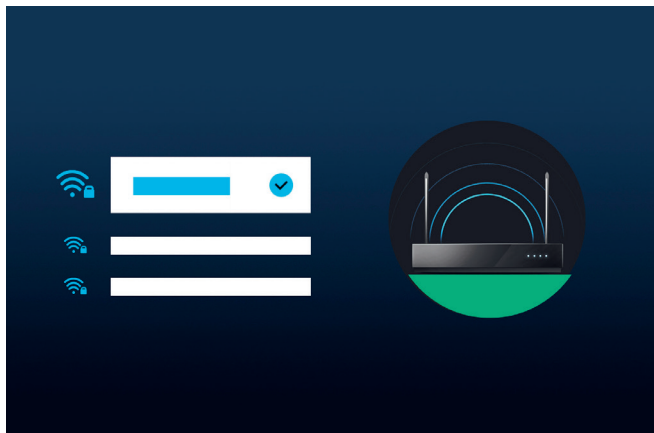

### Connexion au réseau local.

Lorsque vous utilisez le réseau local sans fil, vous êtes invité à saisir votre mot de passe. Utilisez les touches directionnelles et la touche de sélection , pour sélectionner les chiffres et les lettres. Confirmez avec .

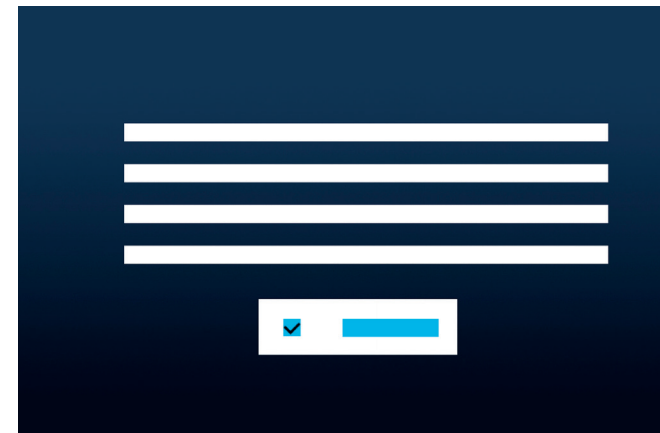

### Conditions générales d'utilisation, politique de confidentialité.

Pour utiliser toutes les fonctionnalités de l'appareil, vous devez accepter les conditions générales et la politique de confidentialité du Smart Hub. Pour ce faire, appuyez sur le bouton de sélection et cliquez sur « J'accepte tout ».

Sans acceptation des conditions générales et de la politique de confidentialité, le fonctionnement de certains services ne peut être garanti.

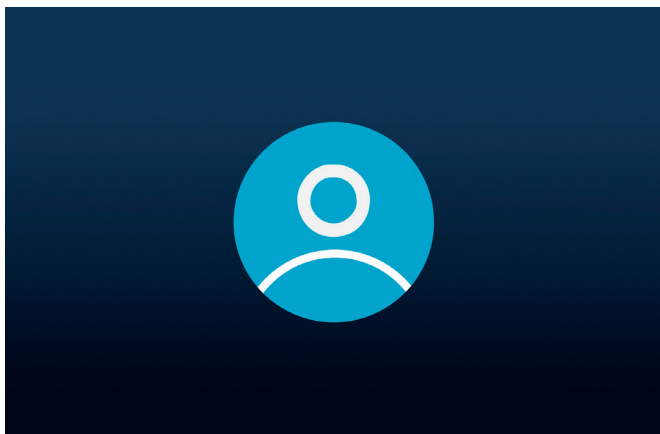

## Création d'un compte utilisateur.

Étape facultative : Appuyez sur la touche directionnelle  pour sauter cette étape. Connectez-vous à votre compte Samsung existant ou créez-en un nouveau. En utilisant un compte Samsung, vous bénéficiez des meilleures fonctionnalités de votre appareil intelligent et le gardez toujours à jour.

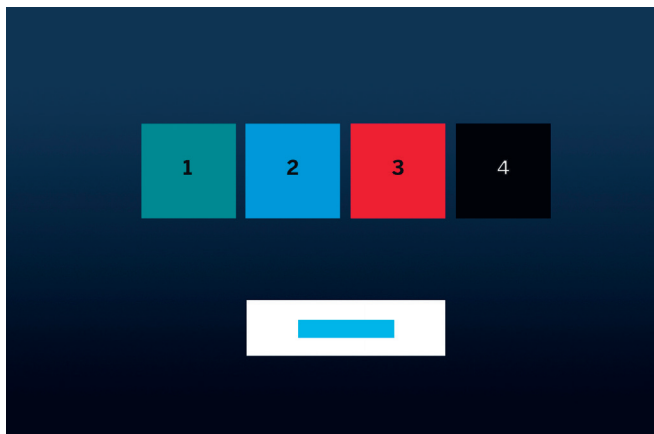

## Personnalisation de la barre des tâches.

Cette étape vous permet d'enregistrer et de trier les applications dans la barre des tâches. Certaines applications sont déjà préinstallées. Les applications peuvent également être personnalisées ultérieurement dans le Smart Hub.

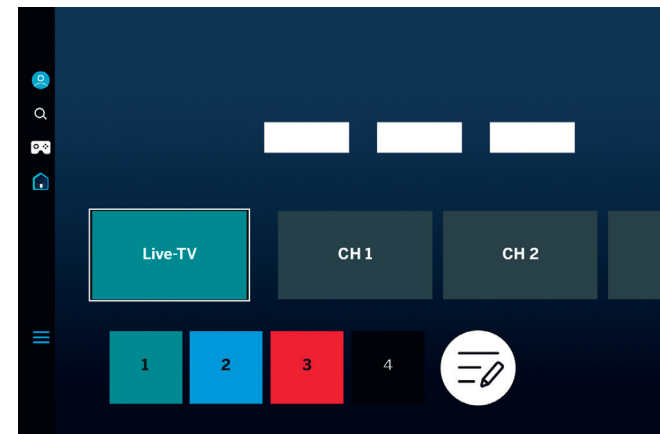

## Écran d'accueil.

Une fois que l'écran d'accueil s'affiche, la configuration initiale est terminée. Il est temps de commencer votre expérience télévisuelle. Ouvrez la télévision en direct ou votre application préférée. Nous espérons que vous apprécierez votre nouveau téléviseur Loewe.

 Un compte utilisateur est nécessaire pour utiliser les applications ou la vidéo à la demande.

Smart-Hub.

# Écran d'accueil.

Le Smart Hub est l'écran d'accueil de votre téléviseur. De là, vous pouvez lancer des applications, des services ou regarder la télévision en direct.

 Appuyez sur la touche Home de votre télécommande pour revenir immédiatement à cet écran.

Les options suivantes sont disponibles :

 Profil de l'utilisateur : Accéder au profil de l'utilisateur.

 Rechercher : Rechercher des chaînes, des films ou des applications. Commande vocale avec la télécommande Loewe stellar mini.

 Hub de jeux : Diffuser les jeux en direct.

 Écran d'accueil : Modifier la disposition des applications.

 Appareils connectés  / Paramètres 

 Modifiez les paramètres de confidentialité.

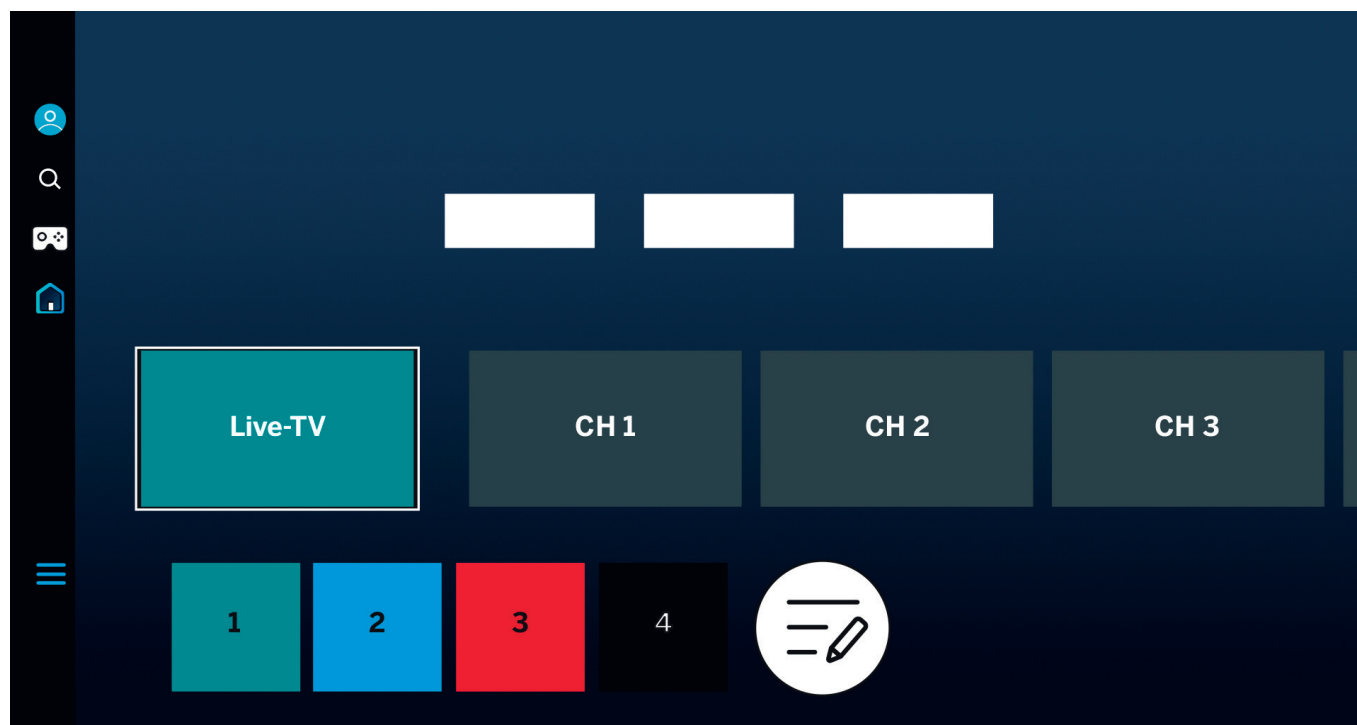

Utilisez les touches directionnelles  pour naviguer. La tuile surlignée et agrandie est actuellement sélectionnée.

Lancez les applications installées, les services ou la télévision en direct en appuyant sur la touche de sélection . D'autres paramètres sont disponibles à gauche :

Profil de l'utilisateur, recherche, mode ambiant, hub de jeux, médias et politique de confidentialité.

 L'affichage et les informations peuvent varier en fonction du pays et de la région.

D'un coup d'œil.

# Guide électronique des programmes.

Le guide électronique des programmes (GEP) fournit des informations sur le programme de télévision en cours et à venir. Vous pouvez également l'utiliser pour programmer des enregistrements.

 Appuyez sur la touche guide de votre télécommande pour ouvrir le guide des programmes.

Les options suivantes sont disponibles :

 Modifier les filtres des chaînes.

 Afficher uniquement la chaîne de télévision.

 Afficher uniquement les stations radio.

 Modifier les chaînes.

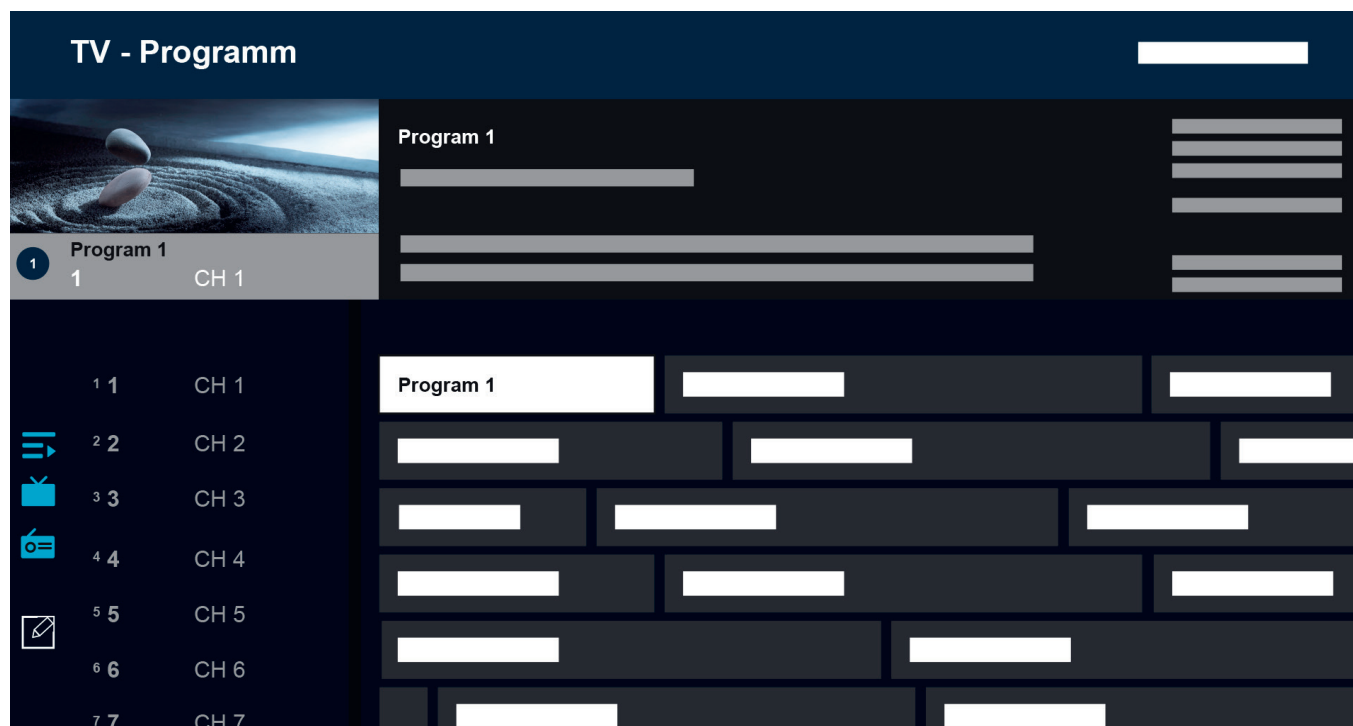

Caractéristiques supplémentaires du GEP :

- Aperçu de l'image en direct.
- Informations sur le programme en cours.
- Affichage de la date et de l'heure.
- Aperçu de toutes les chaînes disponibles.
- Présentation de la mini-télécommande Loewe stellar.

Plus d'informations sont disponibles dans le manuel électronique de Tizen OS.

 L'affichage et les informations peuvent varier en fonction du pays et de la région.





Enregistrement avec dr+.

## Enregistrements multiples.

Enregistrez des programmes avec Loewe stellar, programmez un enregistrement ou utilisez Timeshift pour regarder un programme TV en direct plus tard. Les enregistrements sont automatiquement stockés sur le disque dur intégré. Si vous le souhaitez, vous pouvez également utiliser un périphérique de stockage USB externe approprié.

### Enregistrement immédiat.

Sélectionnez un programme de télévision en direct que vous souhaitez enregistrer et appuyez sur la touche d'enregistrement  ou . Sélectionnez « Enregistrement  » dans le menu contextuel suivant pour commencer.

### Enregistrement programmé.



Ouvrez le GEP et choisissez un programme que vous souhaitez enregistrer. Confirmez avec  et sélectionnez « Enregistrement programmé » dans le menu contextuel suivant pour commencer. Les enregistrements manuels peuvent être programmés dans le gestionnaire de programmes.



### Gestionnaire d'enregistrements et de programmes.



Le gestionnaire d'enregistrements et de programmes offre une vue d'ensemble des enregistrements passés et programmés.

### Enregistrements.

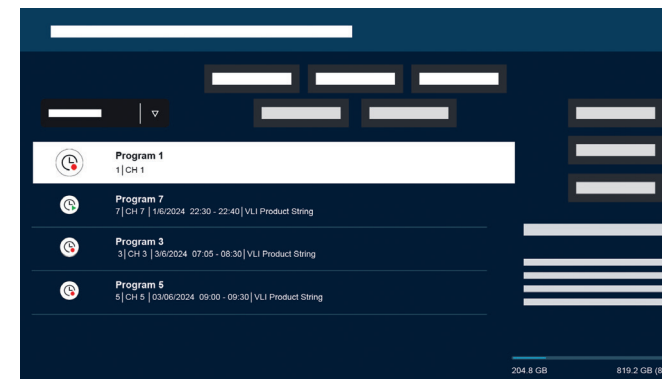
En mode TV en direct, ouvrez la liste des enregistrements disponibles en appuyant sur  et sélectionnez . Sélectionnez l'enregistrement souhaité à l'aide des touches directionnelles et validez avec  pour le lire.



### Programmation.

En mode TV en direct, appuyez  sur et sélectionnez  pour obtenir une vue d'ensemble de tous les enregistrements programmés. Le bouton « Ajouter un enregistrement » permet de programmer des enregistrements manuels ou en série.

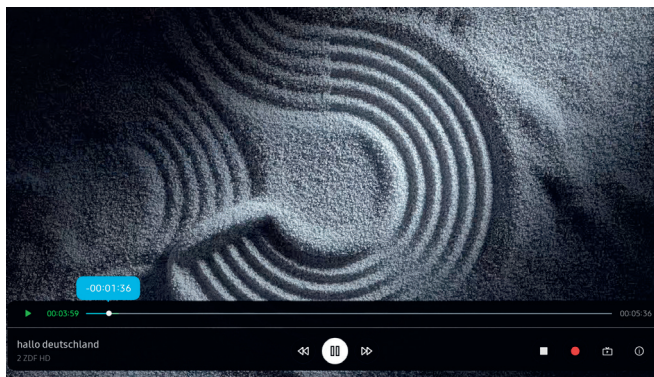
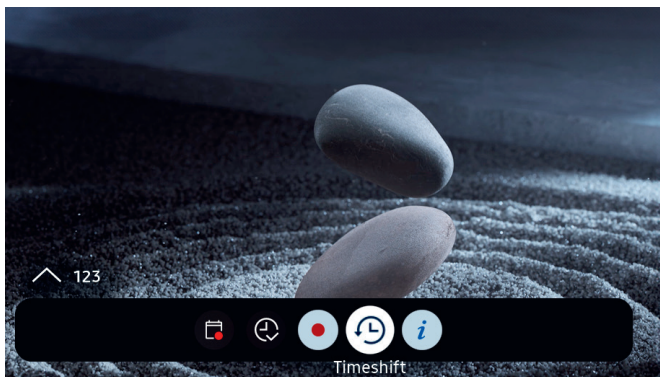

## Timeshift.

Appuyez sur  pour activer le Timeshift.







Lorsque la fonction Timeshift est activée, vous pouvez mettre un programme en pause et le regarder à nouveau plus tard, ou même regarder à nouveau certaines parties du programme.

 Capacité d'enregistrement maximale :  
90 minutes.

Appuyez sur la touche directionnelle vers le bas  pour afficher la barre de progression dans le menu Timeshift.

Utilisez les touches directionnelles pour naviguer dans le menu Timeshift.

## Menu Timeshift :

-  Lecture/pause Timeshift.
-  Avance rapide.
-  Retour en arrière.
-  Arrêt du Timeshift.
-  Démarrer l'enregistrement.
-  Retour à la télévision en direct. Le Timeshift reste actif.
-  Info.

Veillez lire toutes les consignes de sécurité avant d'utiliser Timeshift, en particulier la section « Disques durs USB connectés ». La déconnexion de l'appareil de l'alimentation électrique peut entraîner la perte de données.

De plus amples informations sont disponibles dans le manuel électronique, section « Avant d'enregistrer et d'utiliser le Timeshift ».

Une réception brillante.

# Loewe magic.light

Chaque Loewe Stellar est équipée de la fonction intégrée magic.light de Loewe. Utilisez la bande LED discrètement cachée pour des illuminations subtiles de bienvenue et d'adieu ou pour faire ressortir votre film préféré dans un ton blanc chaud.

Personnalisez magic.light en fonction de vos souhaits et de votre humeur du moment. Pour en savoir plus sur cette fonctionnalité, consultez cette section.



- Activer les paramètres : Appuyez sur la touche magic.light et confirmer avec .
- Permet d'allumer ou d'éteindre le bandeau lumineux.
- Réglez la luminosité à l'aide des touches directionnelles.
- Réglez la saturation à l'aide des touches programme.
- Réglez les couleurs à l'aide des touches directionnelles.





Blanc chaud : Saturation à 100%  
Blanc froid : Saturation à 0%



## Réglage de la durée d'éclairage.

- Appuyez simultanément sur la touche magic.light  et la touche réglages  pendant cinq secondes. La signature.ring de Loewe affichera une ligne avec sept points blancs. Le nombre de points indique la durée de l'éclairage :



- Désormais, vous pouvez ajuster la durée. La ligne à l'intérieur de la signature.ring change lorsque l'on appuie à gauche et à droite .
- Appuyez sur  pour enregistrer la configuration.

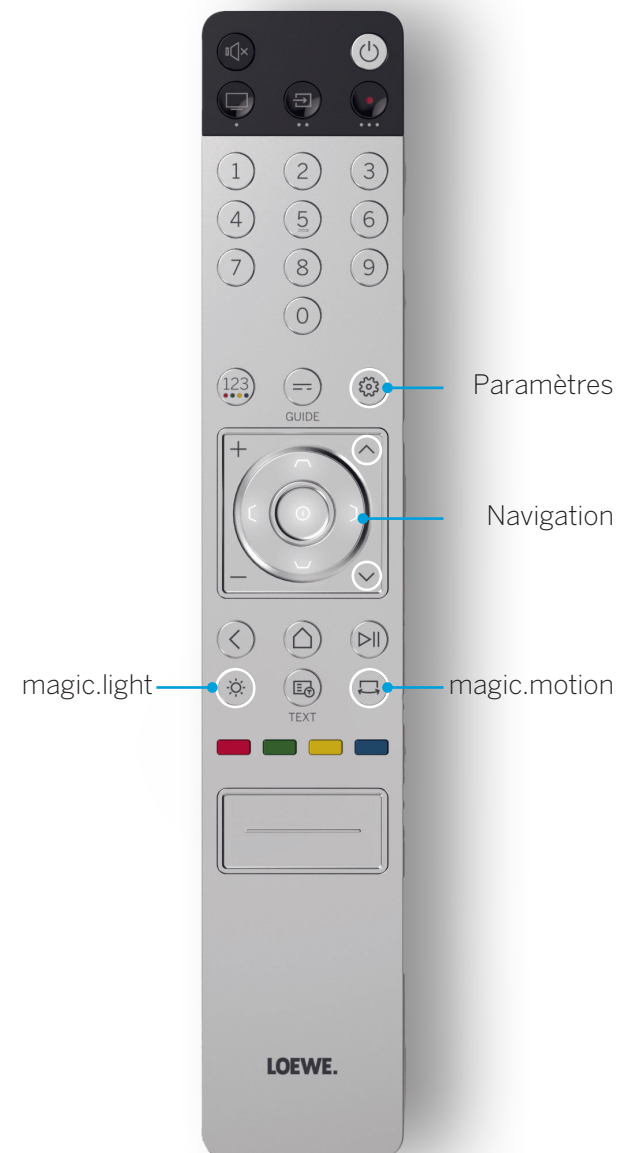

L'angle parfait.

## Loewe magic.motion

Grâce à la fonction magic.motion, il est possible de faire pivoter le téléviseur sur le socle motorisé optionnel Loewe Floor Stellar en appuyant sur un bouton.

La touche magic.motion  de votre télécommande Loewe stellar permet d'activer cette fonction.

---



 Appuyez sur la touche magic.motion.

---







 Appuyez sur les touches directionnelles pour faire pivoter le téléviseur. Angle de rotation maxi. : 45°

---

### Réglage de la rotation.

Appuyez simultanément sur la touche magic.motion  et la touche réglages  pendant cinq secondes. Vous entendrez une brève tonalité. Le mode de configuration est maintenant actif.

En appuyant sur les touches directionnelles , vous pouvez faire pivoter le téléviseur dans l'une ou l'autre direction.

1. Appuyez sur la touche directionnelle gauche  et maintenez-la enfoncée pour tourner l'appareil complètement vers la gauche. Appuyez sur  pour enregistrer cette position. Vous entendrez deux courtes tonalités.
2. Appuyez sur la touche directionnelle droite  et maintenez-la enfoncée pour tourner l'appareil complètement vers la droite. Appuyez sur  pour enregistrer cette position. Vous entendrez trois courtes tonalités.
3. Appuyez à nouveau sur la touche directionnelle gauche et maintenez-la enfoncée, puis remettez l'appareil dans la position d'arrêt souhaitée. Appuyez sur  pour enregistrer également cette position. Vous entendrez quatre courtes tonalités.
4. Pour terminer, appuyez à nouveau sur  pour confirmer qu'il s'agit de la position par défaut lors de l'allumage et de l'extinction de l'appareil.
5. Vous entendez maintenant une longue tonalité. Le mode de configuration est terminé.



Reconnaissance des obstacles : magic.motion s'arrête automatiquement lorsqu'il rencontre un obstacle.



20 secondes d'inactivité annulent la configuration.

Bon à savoir.

## Applications et informations techniques.

### Téléchargez l'application my Loewe.

Utilisez votre smartphone pour scanner le code QR ci-dessous et téléchargez l'application recommandée. « my Loewe » est votre point d'entrée dans le monde Loewe et vous donne accès à tous les manuels d'utilisation de vos produits Loewe.



### Informations techniques.

Vous avez acheté un téléviseur avec un écran OLED qui répond aux normes de qualité les plus élevées et qui a été contrôlé pour détecter les défauts de pixels. Malgré le plus grand soin apporté à la fabrication de l'écran, pour des raisons techniques, il n'est pas possible de garantir à 100 % qu'aucune erreur de sous-pixel ne se produira. Toutefois, tant que ces effets restent dans les limites spécifiées par la norme (ISO 9241-307, classe de défaut II), ils ne sont pas considérés comme des défauts de l'équipement au sens de la garantie. Les diodes électroluminescentes organiques (Organic Light Emitting Diodes - OLED) sont une technologie d'imagerie basée sur des pixels auto-éclairés qui offrent des avantages significatifs en termes de qualité d'image et de performance. Dans certaines circonstances, une exposition unilatérale persistante au matériau OLED peut entraîner des aberrations permanentes et irréversibles de l'image. Ces problèmes d'images résiduelles surviennent lorsque le téléviseur affiche un contenu statique tel que des images statiques, des sous-titres, des téléscripteurs, des diaporamas ou des séquences vidéo en boucle infinie, des affichages statiques sur un moniteur de

présentation ou des jeux vidéo. Les barres noires sur certains formats d'écran peuvent également entraîner des problèmes d'image résiduelle. Il est important de souligner que ces problèmes d'images résiduelles ne constituent pas des défauts au sens de la garantie. Si des images statiques sont affichées trop longtemps, le téléviseur réduit automatiquement le contraste ou passe en mode d'économie d'écran. La prochaine fois que l'utilisateur allume l'appareil, celui-ci revient immédiatement à son état normal. Dans des conditions d'affichage normales, il n'y a pas de problème d'image résiduelle. Afin de maintenir durablement la qualité élevée de l'affichage de l'image, votre téléviseur Loewe OLED se calibre lui-même à intervalles réguliers.

### Disques durs USB connectés.

Le fait de débrancher le téléviseur en cours de fonctionnement ou une interruption accidentelle de l'alimentation électrique (par exemple, une panne de courant) peut endommager le système de fichiers du disque dur et donc entraîner la perte des émissions enregistrées. Ne déconnectez jamais le périphérique de stockage USB du téléviseur. Nous vous recommandons de mettre le téléviseur en veille avant de le débrancher. Loewe décline toute responsabilité en cas de perte de données stockées sur le disque dur intégré du téléviseur.

### Mises à jour logicielles.

Les dernières versions du logiciel peuvent être téléchargées à partir du site Web de Loewe (voir ci-dessous) et installées sur votre téléviseur à l'aide d'une clé USB. Si votre téléviseur est

connecté à Internet, vous pouvez le mettre à jour directement à partir d'Internet. Vous trouverez de plus amples informations sur les mises à jour du logiciel dans le manuel d'utilisation, qui peut être téléchargé sur le site Internet de Loewe. Il n'est pas possible de garantir que les modèles Loewe fonctionnent en permanence avec tous les périphériques raccordables.

### Clause de non-responsabilité concernant les services numériques.

Nos téléviseurs sont des « produits avec éléments numériques », dont les fonctions principales, notamment la réception de la télévision par câble ou satellite ou la lecture de DVD/Blu-ray via un lecteur connecté au téléviseur, peuvent en principe être utilisées sans ces éléments numériques. Les éléments numériques disponibles sur l'appareil comprennent, entre autres, des applications, des jeux, de la musique, des services vidéo et d'autres programmes, ainsi que des plateformes qui vous permettent de télécharger et/ou d'accéder à des applications supplémentaires. Les services, contenus et/ou éléments mentionnés ci-dessus, ainsi que les plateformes de serveurs nécessaires, auxquels ils accèdent en arrière-plan via Internet, sont proposés et/ou fournis par des prestataires tiers. Veuillez tenir compte des conditions d'utilisation et/ou des conditions générales de ces fournisseurs tiers, que vous devrez accepter ultérieurement, notamment lors de la première installation du téléviseur, mais aussi lors de l'utilisation de services tiers. Cette acceptation crée une relation contractuelle directe entre vous et les fournisseurs de services tiers



# Déclaration.

respectifs en ce qui concerne l'utilisation des éléments, services et/ou contenus numériques respectifs. En tant que fabricant de téléviseurs, la société Loewe Technology GmbH n'a aucune influence sur la mise à disposition d'éléments numériques, de services et de contenus, leur qualité, leur présentation visuelle, la mise à disposition de mises à jour et, en particulier, la fin de vie de ces éléments numériques, services et contenus. D'autre part, pendant la durée de vie du téléviseur, de nouveaux éléments, services et/ou contenus numériques peuvent également être proposés sur l'appareil sans votre consentement habituel. Ces éléments, services et/ou contenus numériques supplémentaires résultent, entre autres, du progrès technologique et des exigences générales du marché. Toutefois, il n'y a aucune obligation de fournir de nouveaux éléments, services et/ou contenus numériques. En particulier, il n'y a aucune obligation de fournir un remplacement ou un successeur après la fin de vie d'un élément numérique, d'un service ou d'un contenu. Veuillez vous référer à l'utilisateur final et/ou aux conditions générales applicables à votre appareil.



Loewe Technology GmbH confirme que son produit est conforme aux exigences essentielles de la directive 2014/53/UE, ainsi qu'à d'autres directives européennes pertinentes.

Dans la gamme de fréquences 5150 à 5350 Mhz, ce téléviseur ne peut être utilisé qu'à l'intérieur dans les pays suivants :

Allemagne, Autriche, Belgique, Bulgarie, Chypre, Croatie, Danemark, Espagne, Estonie, Finlande, France, Grèce, Hongrie, Irlande, Italie, Lettonie, Lituanie, Luxembourg, Malte, Pays-Bas, Pologne, Portugal, République tchèque, Roumanie, Royaume-Uni, Slovaquie, Slovénie, Suède.

Vous pouvez trouver la déclaration de conformité complète dans la sélection de produit sur :

**[www.loewe.tv/eu/en/service/support](http://www.loewe.tv/eu/en/service/support)**

# Impression.

Loewe Technology GmbH  
Industriestraße 11  
96317 Kronach, Allemagne  
[www.loewe.tv](http://www.loewe.tv)

Tribunal d'enregistrement : Frankfurt am Main, HRB 117013  
Représenté par : Aslan Khabliev

Les informations contenues dans ce document peuvent être modifiées sans préavis. Tous droits réservés, y compris la traduction, les modifications techniques et les erreurs.







# Loewe stellar. Prodotto in Germania.

## Benvenuto.

Grazie mille per aver scelto Loewe stellar. Siamo eccitati di darti il benvenuto come cliente. Design, innovazione e tecnologia all'avanguardia - hai scelto un dispositivo che unisce tutte queste qualità in un unico prodotto eccellente. Questo modello di TV OLED di Loewe conquista il suo pubblico grazie alla più moderna tecnologia del display, alle prestazioni hardware e a un nuovo linguaggio di design.

Loewe stellar è prodotto in Germania.

Ogni dettaglio di questo prodotto riflette la devozione e la maestria che distinguono Loewe e i suoi dipendenti da oltre 100 anni. Goditi l'esclusivo concetto di luce di Loewe stellar e rendi magico ogni momento grazie a questa linea di prodotti eccellente. Il dual-channel dr+ di Loewe con triplo sintonizzatore rivela una nuova esperienza di TV – goditi visione e registrazione multiple con una qualità impeccabile.

Per gli appassionati del gioco, stellar offre supporto completo per HDMI 2.1 e Ultra HD @ 144 Hz VRR, per un'esperienza di gioco super veloce e senza problemi. La nostra linea completa di app di streaming e servizi VOD, alimentata dall'eccellente Tizen OS, assicura divertimento per tutti.

Ti preghiamo di leggere queste istruzioni con attenzione. Per avere la certezza di godere del prodotto Loewe

per un lungo periodo, osserva le istruzioni per la sicurezza che sono allegate separatamente. In caso di domande o se hai bisogno di aiuto, l'assistenza clienti Loewe è sempre a tua disposizione.



In questa sezione del manuale utente, troverai informazioni importanti su come installare la Loewe TV. Dopo la prima accensione, una guida intuitiva all'avvio ti guiderà attraverso il processo di configurazione.

Un eManual dettagliato è disponibile per il download dal sito web Loewe. Fornisce descrizioni complete delle funzioni e delle caratteristiche della tua nuova TV Loewe.



[www.loewe.tv](http://www.loewe.tv)

## Indice.

Benvenuto.	101
Simboli e targhetta con il tipo.	102
Contenuto della consegna.	103
Panoramica - TV.	104
Primi passi - Installazione della TV.	106
Panoramica - Telecomando.	108
Primi passi - Telecomando.	110
Primi passi - Configurazione iniziale.	112
Schermata Pagina iniziale	116
Guida elettronica ai programmi.	117
Registrazione multipla	118
Loewe magic.light	120
Loewe magic.motion	121
App e informazioni tecniche.	122
Dichiarazione.	123
Stampa.	123

Simboli e relativo significato.

## Simboli e targhetta con il tipo.

Questo manuale utente contiene numerosi simboli che sono spiegati in questa pagina. Leggi questa sezione con attenzione e annota il significato.

La targhetta con il tipo contiene informazioni importanti sul dispositivo:

- Nome del dispositivo
- Tipo di dispositivo
- Numero articolo
- Numero di serie



Le avvertenze richiamano l'attenzione su problemi che possono danneggiare la tua salute o la tua vita o quelle degli altri. Presta attenzione alle avvertenze.



Gli avvisi ambientali contengono informazioni su azioni o smaltimento rispettosi dell'ambiente. Presta attenzione alle informazioni sull'ambiente.



Suggerimenti e consigli generali in merito al dispositivo o a un'applicazione del dispositivo.



Gli avvisi elettronici richiamano l'attenzione sui pericoli che, se ignorati, potrebbero danneggiare il dispositivo o la tua salute o la tua vita.



Le avvertenze di pericolo di rottura indicano che c'è un rischio di danni al dispositivo o che sono possibili lesioni. Presta attenzione alle avvertenze di pericolo di rottura.

Posizione della targhetta con il tipo.

L'etichetta con il numero di modello e la tensione operativa si trova nella parte posteriore della TV.

Esempio di targhetta con il tipo:



**stellar.65**

Ultra HD / OLED / CI+ / DR+

Art.No. 63470 B 10 Ser.No. 00001 / 3463

CH-TYP SL950

220-240V~ 50/60Hz 450 W



**LOEWE.**

Loewe Technology GmbH  
Industriestraße 11  
D-96317 Kronach

Manufactured  
in Germany

Tutto ciò di cui hai bisogno.

## Contenuto della consegna.

Assicurati che tutto il contenuto della confezione e la box di benvenuto Loewe siano presenti. Se manca qualcosa, contatta il rivenditore o il centro assistenza clienti Loewe.

### Indice.

- Loewe quick start guide
- Manuale utente (questo documento)
- Loewe stellar
- Supporto
- Cavo di alimentazione
  
- Box di benvenuto Loewe
  - Loewe remote stellar
  - Loewe remote stellar mini
  - Batterie tipo AAA
  - Tabella dati tecnici stellar
  - Istruzioni per la sicurezza della TV OLED di Loewe
  - Istruzioni di montaggio per il supporto
  - Kit di montaggio per il supporto

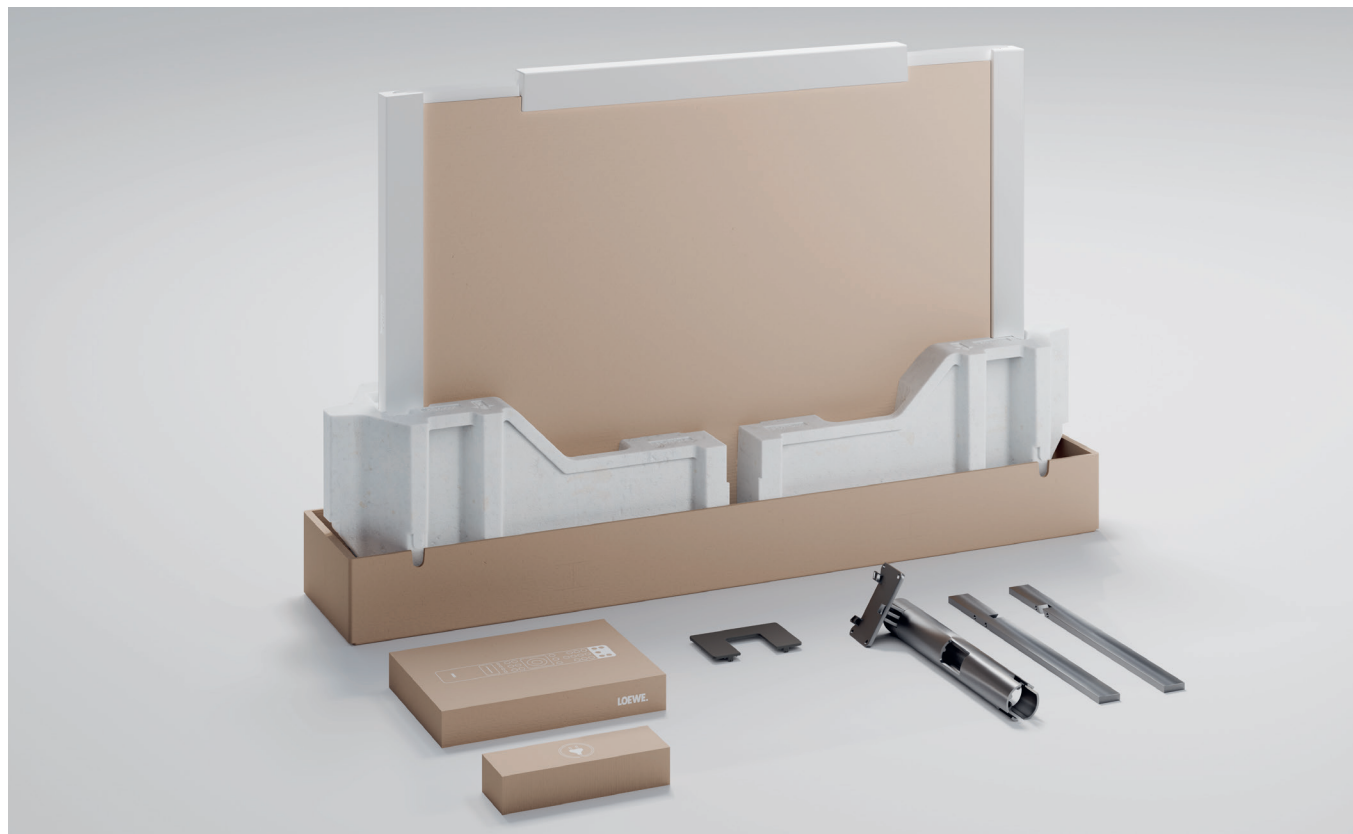



Parte anteriore.

## Panoramica - TV.



① Loewe signature.ring

### LED stato TV

- Stand-by
- TV ACCESA: Pannello ATTIVO
- TV ACCESA: Pannello DISATTIVATO
- Stand-by TV: OLED-Aggiorna
- Registrazione attiva
- Timeshift attivo

② Supporto da tavolo Loewe stellar \*

③ Loewe magic.light

④ Soundbar

⑤ Schermo OLED

⑥ Loewe signature.flag

\*A seconda del tipo e della misura.

## Parte posteriore.



①	AC-IN	Connessione di rete - 220-240 V - 50/60Hz
②	LAN*	Connessione di rete RJ-45
③	HDMI 1	HDMI 2.1 con eARC Audio-OUT
④	HDMI 2	Ingresso HDMI 2.1
⑤	HDMI 3	Ingresso HDMI 2.1
⑥	USB-A	USB 2.0 - 5V $\overline{=}$ , 2000 mA max.
⑥	USB-A	USB 2.0 - 5V $\overline{=}$ , 2000 mA max.
⑦	USB-C	USB 3.1 - 5V $\overline{=}$ , 1000 mA max.
⑧	ANT SAT	Presa satellite - DVB-S/S2 HD
	SUB	13/18V, 400mA
⑨	ANT SAT	Ricezione satellite DVB-S/S2 HD
⑬	MAIN	13/18V, 400mA
⑩	ANT TV	Terreste/Antenna TV DVB-C/T/T2 HD
⑪	Common Interface	CI+ V1.4
⑫	HDMI 4	Ingresso HDMI 2.1
⑬	Audio Out Toslink	Jack uscita audio 3,5mm/ TOSLINK
⑭	USB-A	USB 2.0 - 5V $\overline{=}$ , 2000mA max.
⑮	USB-C	USB 3.1 - 5V $\overline{=}$ , 1000 mA max.

\*Si raccomanda l'uso di un cavo LAN Cat5 senza schermatura..

Apertura della confezione e collegamento.

## Primi passi - Installazione della TV.

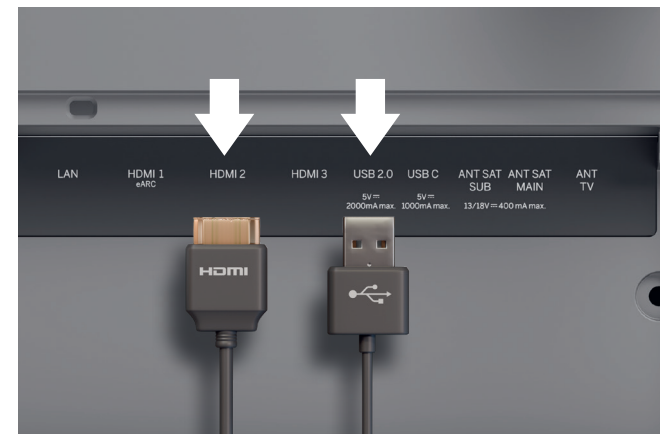

### 1. Apertura della confezione della TV.

Se non hai ancora aperto la confezione della TV, segui i passaggi semplici nella guida all'avvio rapido. Continua fino al punto 2 di questa guida dopo aver fissato in modo sicuro la TV al supporto.

### 2. Collegamento dei cavi dell'antenna.

Adesso collega il cavo del satellite o dell'antenna. Le porte con le etichette si trovano sul retro della TV. Per esporre le porte, rimuovi con attenzione le coperture. Sono facili da rimuovere. Non sono richiesti attrezzi.

### 3. Collegamento di dispositivi aggiuntivi.

I dispositivi aggiuntivi, come console di giochi o dispositivi di memoria, possono essere collegati via HDMI e USB. I dettagli sono disponibili nelle pagine di assistenza nell'eManual e nel sito web Loewe.

 Presta attenzione alle istruzioni per la sicurezza e alle specifiche tecniche.

 Queste informazioni sono necessarie per la configurazione e il funzionamento sicuri della TV.

 Per prima cosa collega i cavi alla TV, quindi al sistema satellitare o al collegamento del cavo. Usa la guida del cavo sulla TV e il supporto Loewe in dotazione.

 Scollega tutti i dispositivi dalla griglia di alimentazione prima di collegarli.



#### 4. Rete via LAN.

Puoi collegare la TV a una rete LAN. Il collegamento a una rete Wi-Fi è spiegato nella sezione che segue "Primi passi - configurazione iniziale".

**i** Usa un cavo RJ45 CAT7 (10/100 Mbps) per il collegamento a una rete LAN.

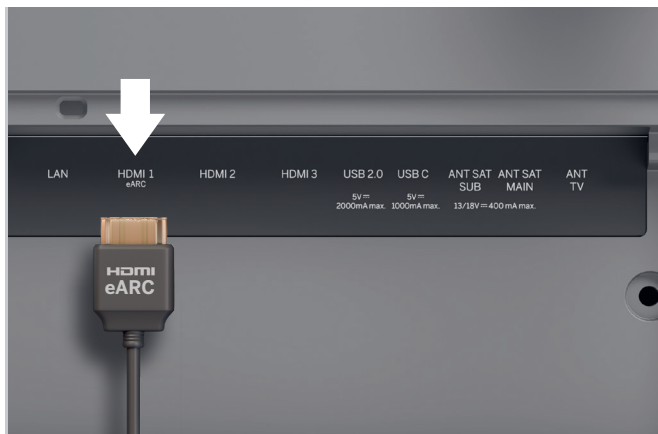

#### 5. Audio via HDMI eARC.

Puoi collegare una klang bar Loewe o il tuo sistema audio alla TV mediante un cavo HDMI. Per farlo, usa la porta HDMI 1, che supporta HDMI 2.1 con USCITA audio eARC.

**i** Usa un cavo HDMI "velocità ultra alta", connettore tipo-A (non incluso), per la massima risoluzione video e eARC.

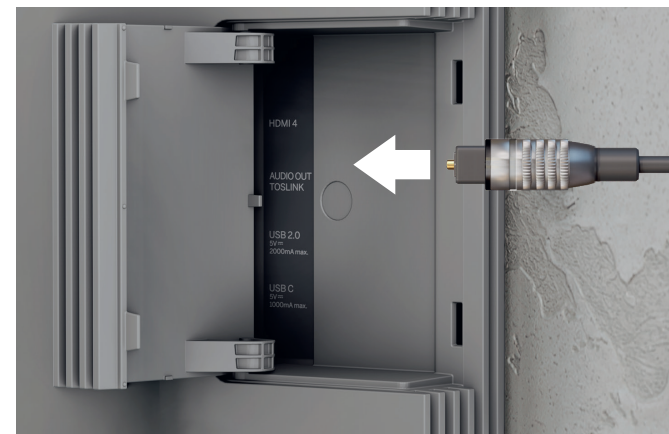

#### 6. Audio: Mini-TOSLINK/analogo.

Puoi collegare un sistema audio mediante TOSLINK alla TV. Il tipo di collegamento dipende dal sistema audio. Collega l'uscita "AUDIO OUT TOSLINK" della TV al sistema audio.

Digitale: Usa un mini-TOSLINK al cavo ottico TOSLINK.

Analogico: Collega un RCA stereo al jack del cavo adattatore per collegare il sistema audio alla TV.

Due per uno.

# Panoramica - Telecomando.

## Loewe **remote stellar**



Funzioni aggiuntive  
Loewe magic.light  
Loewe magic.motion

	ON/OFF	Accensione/spengimento della TV
	Muto	Azzerariattiva l'audio.
	Modalità TV	Pressione breve: TV in diretta, Pressione lunga: Passa dalla TV al dispositivo 1.
	Ingresso	Pressione breve: Apre la lista dei dispositivi, Pressione lunga: Passa al dispositivo 2.
	Registrazione	Pressione breve: Avvia la registrazione, Pressione lunga: Passa al dispositivo 3.
	Programma	Selezione diretta dei canali premendo i tasti numerici.
	123-Funzione	TV in diretta: Menu registrazione, gestione programmi, registrazione, timeshift.
	Guida	Pressione breve: Apre l'EPG, Pressione lunga: Apre la lista dei canali.
	Impostazioni	Pressione breve: Apre le impostazioni, Pressione lunga: Apre tutte le impostazioni.
	Direzione	Cambia l'elemento o il valore selezionati all'interno di un menu. Premi sinistra/destra/su/giù per navigare.
	Selezione	Seleziona/avvia l'elemento attualmente selezionato. TV in diretta: Mostra i dettagli del programma corrente.
	Volume	Aumenta/diminuisce il volume.
	Canale	Canale successivo/precedente.
	Indietro	Pressione breve: Torna all'ultimo menu, TV in diretta: Canale precedente, Pressione lunga: Chiude il menu.
	Schermata Pagina iniziale	Apre la schermata della pagina iniziale.
	Riproduzione/pausa	Riproduce/mette in pausa i media o avvia/mette in pausa/continua il Timeshift.
	magic.light	Apre le impostazioni per magic.light. Consulta la sezione "magic.light Loewe".
	Televideo	Apre/chiude televideo e mediatext.
	magic.motion	Attiva il controllo del motore di magic.motion. Consulta la sezione "magic.motion Loewe".
	Funzione	Menu-dipende dai tasti funzione.
	App	Tasti scorciatoia per avviare app e video per i servizi on demand.











\*opzionale



## Loewe remote stellar mini



 Funzioni aggiuntive  
Comando vocale  
audio

	ON/OFF	Accensione/spegnimento della TV.
	123-Funzione	Inserisce i numeri e cambia i colori. TV in diretta: Menu registrazione, gestione programmi, registrazione, timeshift.
	Microfono	Premi per abilitare il controllo dei comandi vocali.
	Impostazioni	Pressione breve: Apre le impostazioni.
	Direzione	Cambia l'elemento o il valore selezionati all'interno di un menu. Premi sinistra/destra/su/giù per navigare.
	Selezione	Seleziona/avvia l'elemento attualmente selezionato. TV in diretta: Mostra i dettagli del programma corrente.
	Indietro	Pressione breve: Torna all'ultimo menu, TV in diretta: Programma precedente, Pressione lunga: Chiude il menu.
	Schermata Pagina iniziale	Apre la schermata della pagina iniziale.
	Riproduzione/pausa	Riproduce/mette in pausa i media o avvia/mette in pausa/continua il Timeshift.
+/-	Volume	Aumenta/diminuisce il volume.
^/∨	Canale	Canale successivo/precedente.
	Video on demand	Tasti scorciatoia per avviare app e video per i servizi on demand.

Inserimento e sostituzione delle batterie.

## Primi passi - Telecomando.

1. Apri il vano batterie del telecomando sul retro del telecomando. Fai scorrere la copertura del vano batterie, poi sollevalo. Il vano batterie adesso è esposto.



2. Allinea la prima batteria con il terminale positivo come mostrato nell'immagine del telecomando.

 Assicurati che i terminali (+ e -) siano allineati correttamente.

 Controlla se le batterie sono in posizione in sicurezza.

3. Fai scorrere la copertura di nuovo in posizione e chiudi il vano batterie.

Adesso testa il telecomando per assicurarti che funzioni correttamente. Se non è così, ripeti i passaggi.





 L'inserimento delle batterie funziona in modo identico per entrambi i telecomandi.

 Usa solo batterie a prova di perdite AAA LR03 (alcalino-manganese). Sono necessarie due batterie per telecomando.





## Accoppiamento del telecomando Loewe stellar mini.

Quando accendi  la TV per la prima volta, si collega automaticamente al telecomando Loewe stellar mini. Per accoppiare manualmente il telecomando con la TV, puntalo sulla parte anteriore della TV e premi i tasti  e  contemporaneamente per tre secondi.





 Accoppiare il telecomando Loewe stellar non è necessario.

 Conserva le batterie fuori dalla portata dei bambini. Non sostituire le batterie al sole né buttarle nel fuoco.

 Smaltisci le batterie scariche in modo rispettoso per l'ambiente. Per ulteriori informazioni fai riferimento al capitolo Ambiente/Avvisi legali.

## Programmazione dei pulsanti del dispositivo.

Oltre alla funzione diretta, il tasto della TV  e i pulsanti del dispositivo  e  offrono anche l'opzione di azionare gli altri dispositivi Loewe con il tocco di un pulsante. Questa funzione consente un controllo senza problemi degli altri dispositivi audio Loewe, di lettori Blu-ray e altoparlanti set-top di altri fabbricanti. I punti sotto ogni tasto simboleggiano la relativa funzione.



TV in diretta (pressione 1 sec.),  
Modalità: TV Loewe (pressione 3 sec.)



Ingresso (pressione 1 sec.),  
Modalità: klang mr 1/3/5 Loewe (pressione 3 sec.)



Registrazione (pressione 3 sec.),  
Modalità: klang bar Loewe 3/5 mr (pressione 3 sec.)

## Programmazione di altri dispositivi.

Questi tasti possono anche essere assegnati ad altri dispositivi. Ad esempio, se hai un lettore Blu-ray o un ricevitore via cavo collegato a uno dei pulsanti del dispositivo, puoi controllare comodamente il volume e azze-

rare l'audio dal telecomando. Questo rende la gestione del sistema di home entertainment anche più facile e intuitiva. Maggiori informazioni su come programmare il telecomando Loewe stellar sono disponibili sul sito web Loewe.

## Attivazione anello LED e regolazione della luminosità.



Tieni premuto il tasto  e uno dei tasti numerici 1, 2, 3, 4 o 5 contemporaneamente per tre secondi per cambiare la luminosità dei LED per i tasti di direzione.

"1" corrisponde alla impostazione di luminosità più bassa, "5" a quella più alta. Cambia l'illuminazione secondo le tue preferenze.

Veloce e facile.

## Primi passi - Configurazione iniziale.

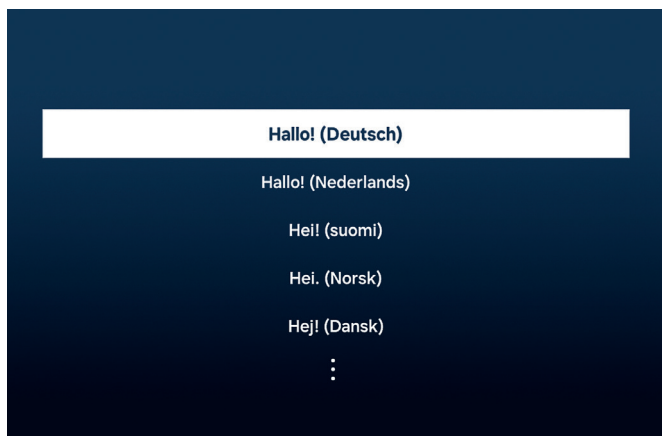

Selezione della lingua del menu.

Per prima cosa seleziona la lingua per il menu. Cambia la lingua con i tasti di direzione . Conferma con .



Avvio della configurazione iniziale.

Loewe stellar è dotato di una guida per la configurazione iniziale. Segui le istruzioni.

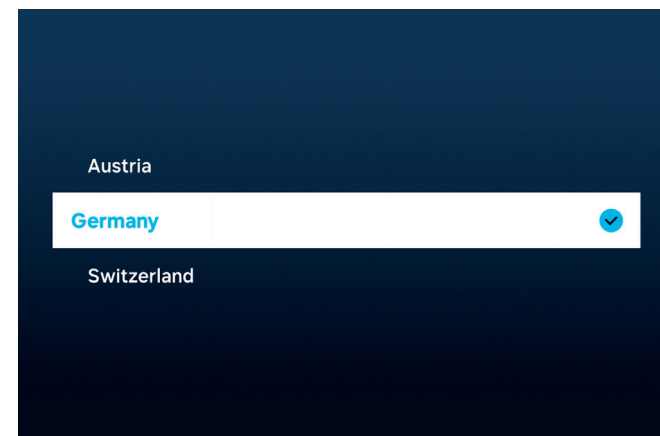

Selezione del Paese.

Adesso seleziona il Paese o la regione usando i tasti di direzione . Conferma con .



Presta attenzione alle istruzioni per la sicurezza e alle specifiche tecniche per questa TV.



La comparsa dell'interfaccia utente potrebbe cambiare dopo un aggiornamento del software.

Centro assistenza clienti Loewe  
[www.loewe.tv](http://www.loewe.tv)

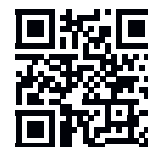

I servizi disponibili possono variare a seconda della regione selezionata.

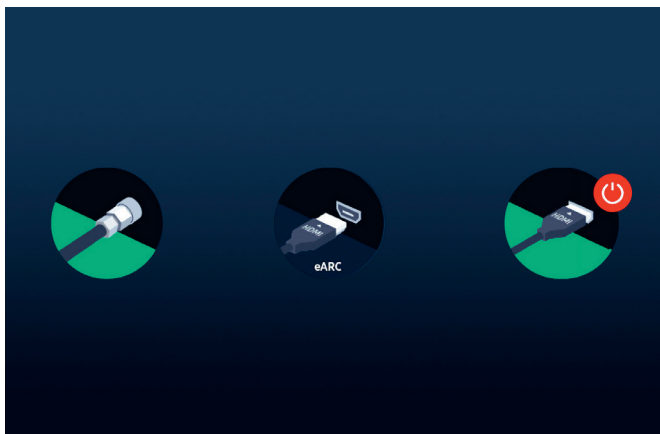

## Riconoscimento automatico dei collegamenti.

Loewe stellar riconosce automaticamente tutte le antenne e i dispositivi collegati mediante USB o HDMI.

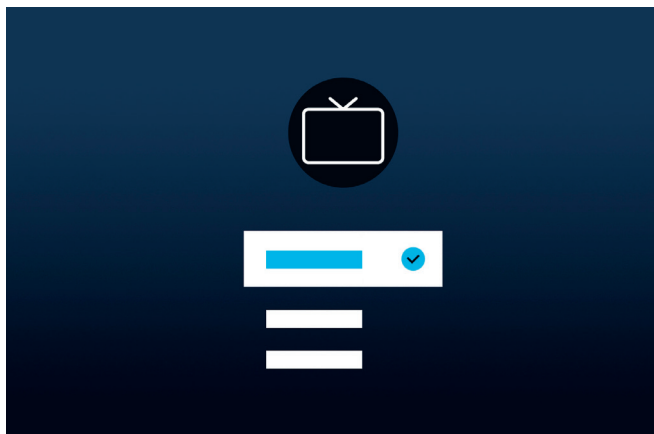

## Ricezione della TV e tipo di programma.

Dopo l'avvenuto riconoscimento di un segnale terrestre o via cavo, seleziona la ricezione della TV e il tipo di programma. Nel passaggio successivo tutti i canali disponibili saranno salvati automaticamente.

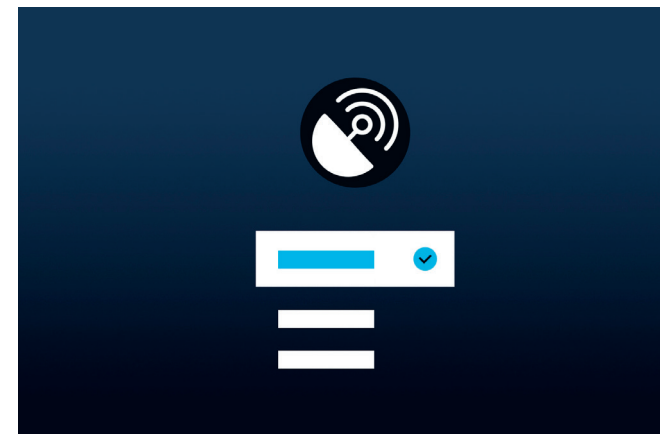

## Segnale satellitare.

Se è disponibile un segnale satellitare, puoi applicare regolazioni di precisione in questo menu.

Regola tipo di programma, selezione del satellite, LNB, portata del satellite e della ricerca. Se si usano SAT MAIN e SAT SUB, puoi scegliere tra dual o main in questo menu.

 Controlla se tutti i dispositivi sono accesi.



Siamo quasi alla fine.

## Primi passi - Configurazione iniziale.

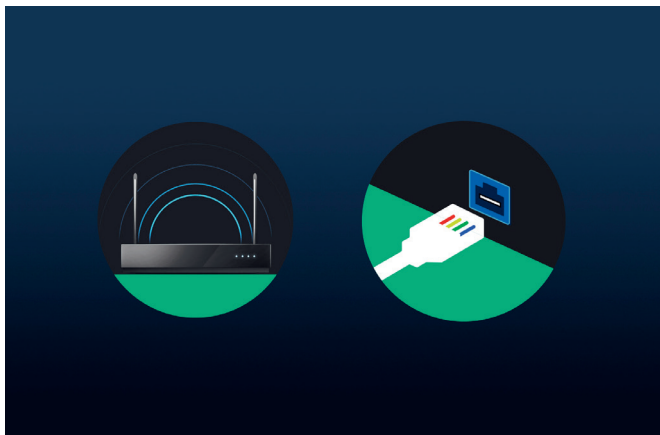

### Selezione di una rete.



Per usare una moderna smart TV secondo il suo massimo potenziale, è necessaria una connessione a Internet. Puoi collegare la TV Loewe a una rete via WLAN (wireless) o LAN (con cavo).

**WLAN** Spiegazione nel punto successivo. Tieni le credenziali WLAN a portata di mano.

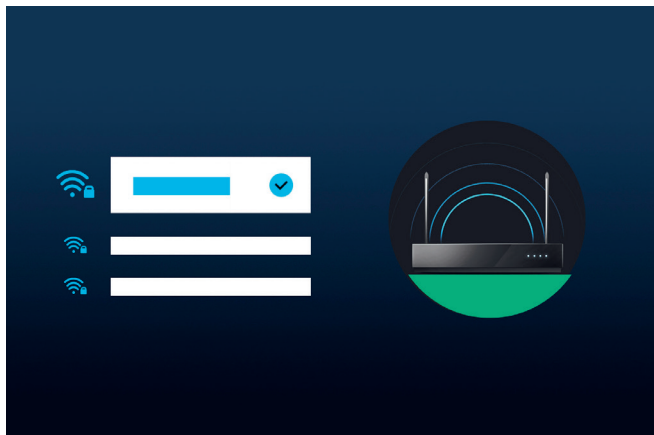
**LAN** Assicurati che una delle estremità del cavo di rete sia collegata alla TV e l'altra al router.



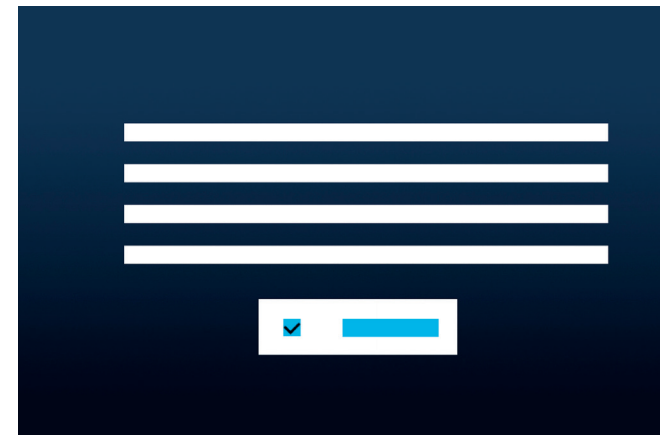

### Collegamento WLAN.

Se usi un collegamento WLAN, adesso ti viene richiesto di inserire una password. Usa i tasti di direzione  e il tasto di selezione , per selezionare numeri e lettere. Conferma con .



### Termini e condizioni, Informativa sulla privacy.

Per usare tutte le funzioni del dispositivo, devi accettare i termini e le condizioni Smart Hub e l'Informativa sulla privacy. Premi il pulsante di selezione  e fai clic su "Accetto tutto" per farlo.

 Senza accettare i termini e le condizioni e l'Informativa sulla privacy, il funzionamento di alcuni servizi non può essere garantito.

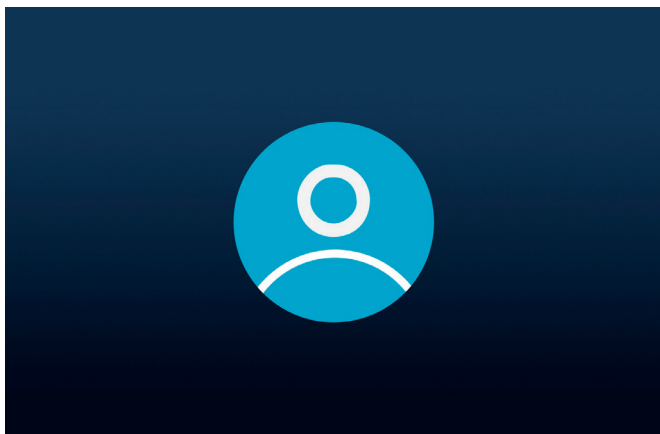

## Creazione di un account utente.

Passaggio opzionale: Premi il tasto di direzione  per saltare questo passaggio. Accedi a un account Samsung esistente o creane uno nuovo. Utilizzando un account Samsung, puoi godere delle migliori funzioni del tuo dispositivo smart e mantenerlo sempre aggiornato.

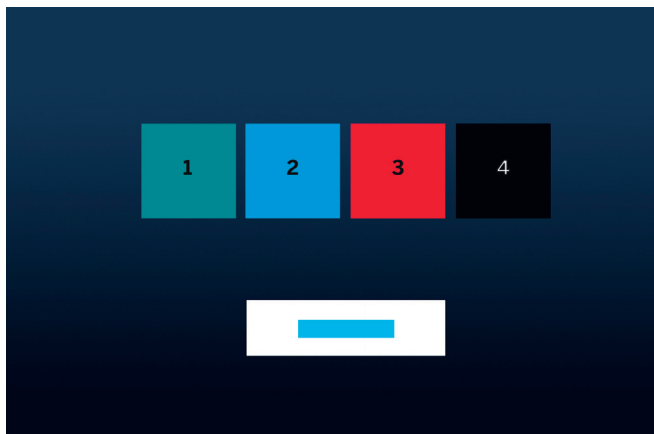

## Personalizzazione della barra delle attività.

In questo passaggio puoi salvare e riordinare le app nella barra delle attività. Alcune app sono già preinstallate. Le app possono essere personalizzate successivamente nello Smart Hub.

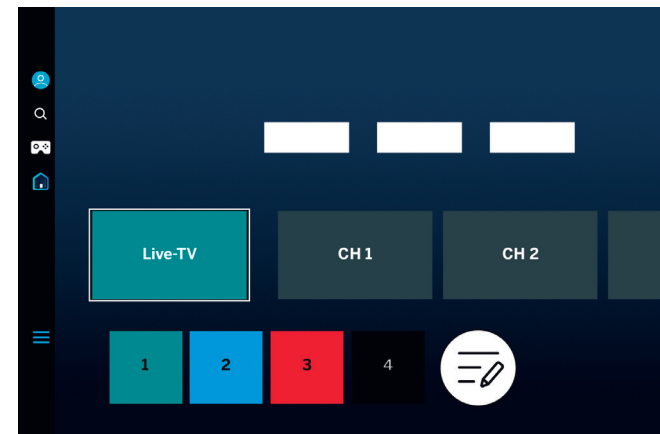

## Schermata Pagina iniziale

Quando compare la schermata della pagina iniziale, la configurazione iniziale è completa. È il momento di iniziare con l'esperienza della TV. Apri la TV o la tua app preferita. Speriamo che la nuova TV Loewe ti piacerà.

 Un account utente è necessario per usare app e video on demand.

Smart-Hub.

## Schermata Pagina iniziale

Lo smart hub è la schermata della pagina iniziale della TV. Da qui puoi lanciare app, servizi o passare nella TV in diretta.

 Premi il tasto Home del telecomando per passare immediatamente a questa schermata.

Sono disponibili le seguenti opzioni:

 Profilo utente: Accedi al profilo utente.

 Ricerca: Ricerca di canali, film e app. Comando vocale con il telecomando Loewe stellar mini.

 Hub giochi: Trasmissione diretta dei giochi.

 Schermata Pagina iniziale: Modifica dell'organizzazione delle app.

 Dispositivi collegati  / Impostazioni 

 Modifica delle impostazioni della privacy.

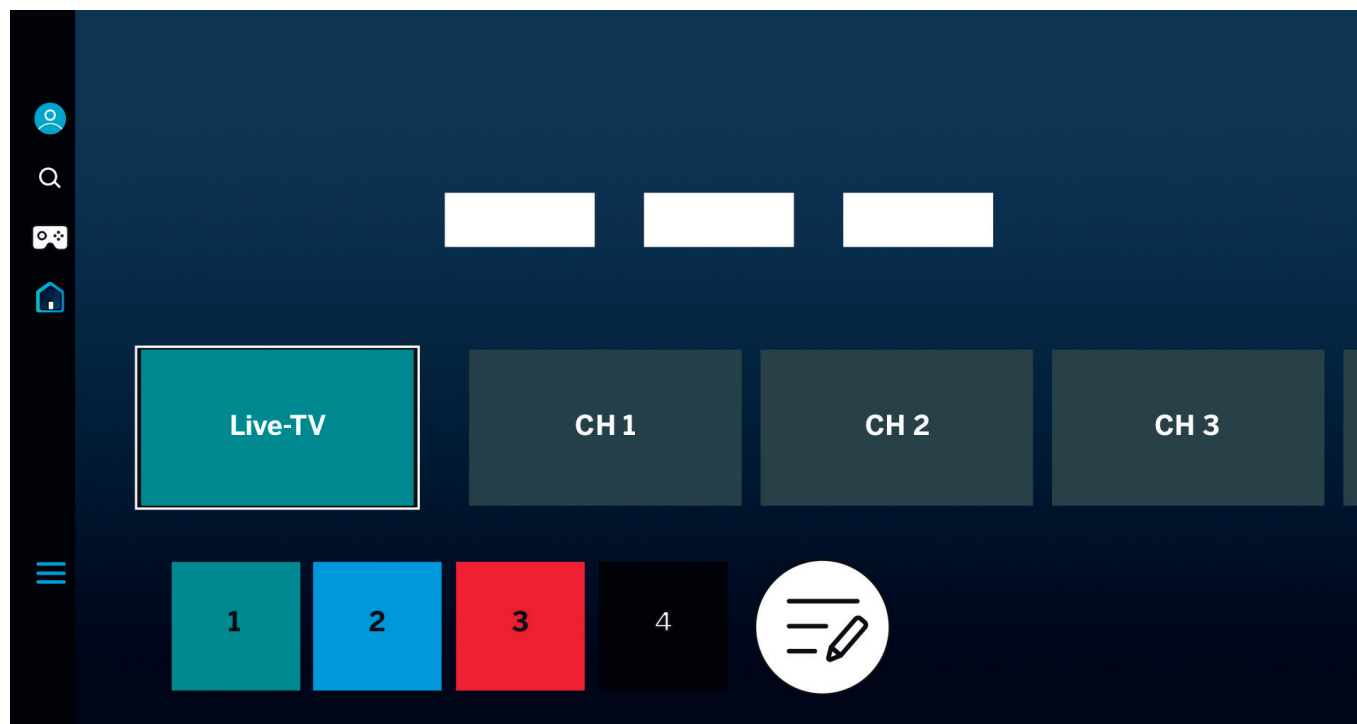

Usa i tasti di direzione  per navigare. La sezione evidenziata e ingrandita è attualmente selezionata.

Lancia le app installate, i servizi o la TV in diretta premendo il tasto di selezione . Altre impostazioni sono disponibili a sinistra: Profilo utente, ricerca, modalità Ambient, hub giochi, media e Informativa sulla privacy.

 A seconda di Paese e regione, il display e le informazioni possono variare.

Panoramica.

## Guida elettronica ai programmi.

La guida elettronica ai programmi (EPG) fornisce informazioni sul programma televisivo corrente e successivo. Puoi anche usarla per programmare le registrazioni.

 Premi il tasto della guida sul telecomando per aprire la guida ai programmi.

Sono disponibili le seguenti opzioni:

 Modifica i filtri dei canali.

 Mostra solo i canali della TV.

 Mostra solo le stazioni radio.

 Modifica i canali.

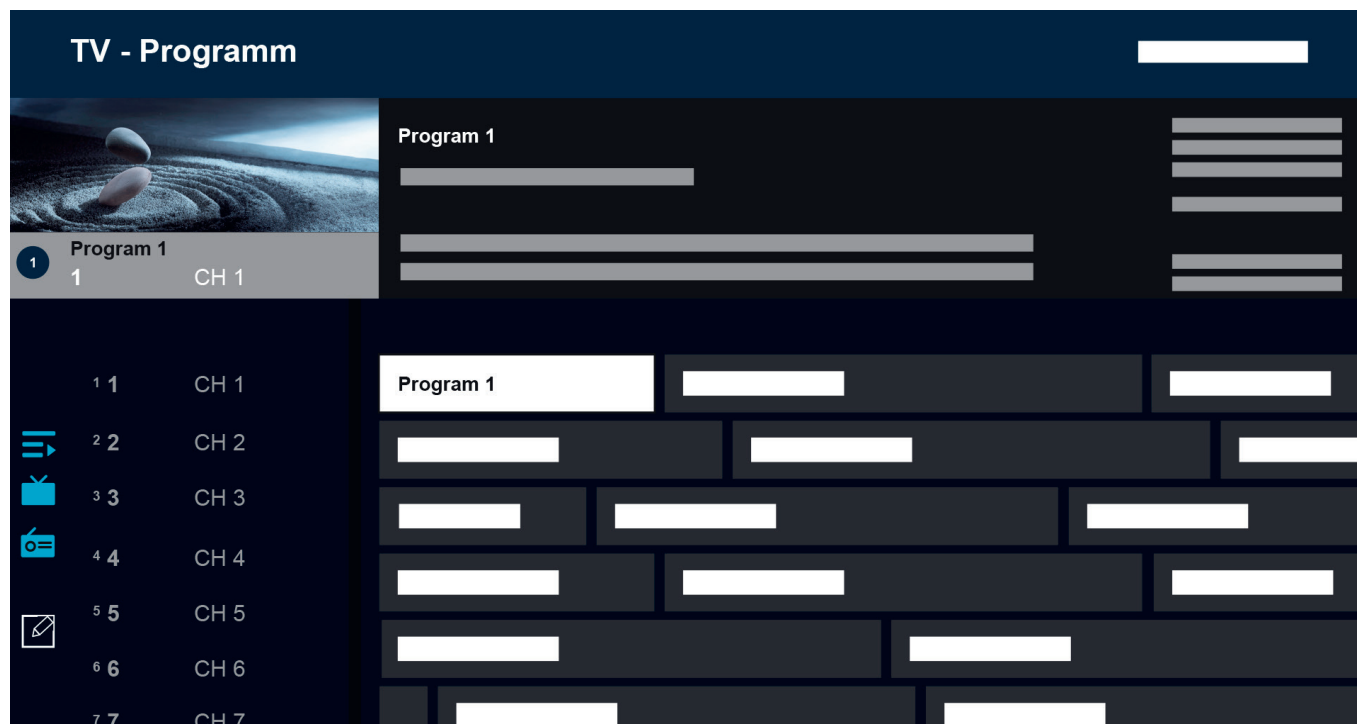

Funzioni aggiuntive della EPG:

- Anteprima immagine in diretta.
- Informazioni sul programma corrente.
- Visualizzazione di data e ora.
- Anteprima di tutti i canali disponibili.
- Panoramica telecomando Loewe stellar mini.

Altre informazioni disponibili su Tizen OS eManual.



 A seconda di Paese e regione, il display e le informazioni possono variare.

Registrazione con dr+.

## Registrazione multipla

Registra i tuoi programmi con Loewe stellar, programma una registrazione o usa il Timeshift per guardare successivamente un programma TV in diretta. Le registrazioni sono memorizzate automaticamente nel disco rigido integrato. Se preferisci, puoi anche usare un dispositivo di memoria USB esterno idoneo.

### Registrazione istantanea.

Seleziona un programma TV in diretta che desideri registrare e premi il tasto di registrazione  o . Per iniziare, seleziona "Registrazione " nel menu che segue con apertura a comparsa.

### Programmazione di una registrazione.



Apri l'EPG e scegli un programma che desideri registrare. Per iniziare, conferma con  e seleziona "Programma registrazione" nel menu che segue con apertura a comparsa. Le registrazioni manuali possono essere programmate nella gestione dei programmi.



### Registrazione e gestione dei programmi.



La registrazione e la gestione dei programmi offrono una panoramica delle ultime registrazioni e di quelle programmate.

### Registrazioni.

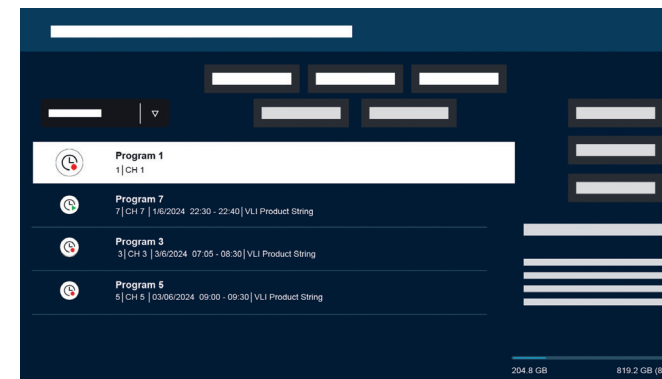
Nella modalità in diretta apri la lista delle registrazioni disponibili premendo  e seleziona . Seleziona la registrazione desiderata con i tasti di direzione e conferma con  per riprodurre.



### Programmazione.

Nella modalità in diretta premi  e seleziona  per avere una panoramica di tutte le registrazioni programmate. Con il pulsante "Aggiungi registrazione" è possibile programmare le registrazioni manuali e seriali.



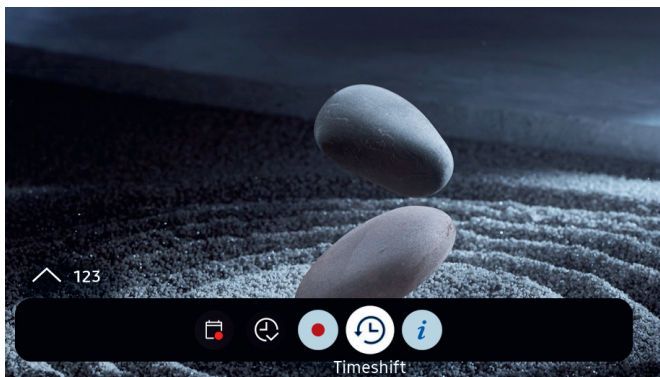

## Timeshift.

Premi  per attivare il Timeshift.

Con il Timeshift attivo puoi mettere in pausa un programma e riprendere la visione successivamente o anche riguardare intere sezioni.

 Max. capacità di registrazione: 90 minuti.

Premi il tasto di direzione verso il basso  per visualizzare la barra di avanzamento nel menu Timeshift.

Usa i tasti di direzione per navigare nel menu Timeshift.

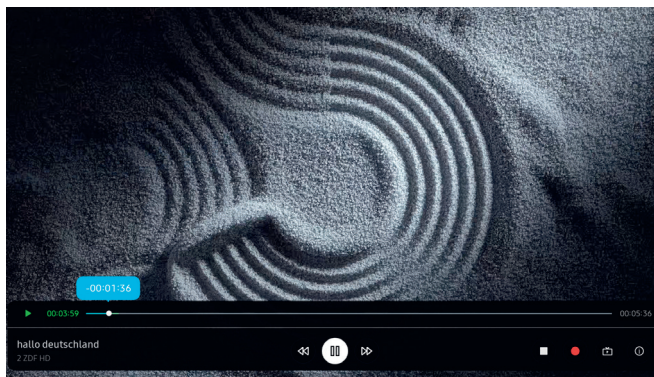

## Menu Timeshift:

-  Riproduzione / Pausa Timeshift.

---

-  Avanzamento veloce.

---

-  Riavvolgimento.

---

-  Arresto Timeshift.

---

-  Avvio registrazione.

---

-  Torna alla TV in diretta. Timeshift resta attivo.

---

-  Info.

---

Leggi tutte le istruzioni per la sicurezza prima di usare il Timeshift, soprattutto la sezione "Dischi rigidi USB collegati". Scollegare il dispositivo dall'alimentazione può comportare una perdita di dati.



Maggiori informazioni sono disponibili nell'eManual, sezione "Prima di registrare e usare il Timeshift".

Una ricezione splendente.

## Loewe magic.light

Ogni Loewe stellar è dotato di Loewe magic.light. Usa la banda LED nascosta per le illuminazioni di benvenuto e arrivederci o per sottolineare il tuo film preferito con un tono bianco caldo.

Personalizza magic.light secondo i tuoi desideri e l'umore corrente. Maggiori informazioni su questa funzione in questa sezione.

 Attivazione delle impostazioni:  
Premi il tasto magic.light e conferma con .

 Accensione o spegnimento della banda.

 Regola la luminosità con i tasti di direzione.

 Regola la saturazione con i tasti dei programmi.



 Regola il colore con i tasti di direzione.





Bianco caldo: 100% saturazione  
Bianco freddo: 0% saturazione



### Regolazione della durata dell'illuminazione.

1. Tieni premuto magic.light  e il tasto delle impostazioni  contemporaneamente per cinque secondi. Loewe signature.ring visualizza una riga con sette punti bianchi. Il numero di punti indica la durata dell'illuminazione:



2. Adesso puoi regolare la durata. La linea interna al signature.ring cambia quando si preme a sinistra e a destra .
3. Premi  per salvare la configurazione.

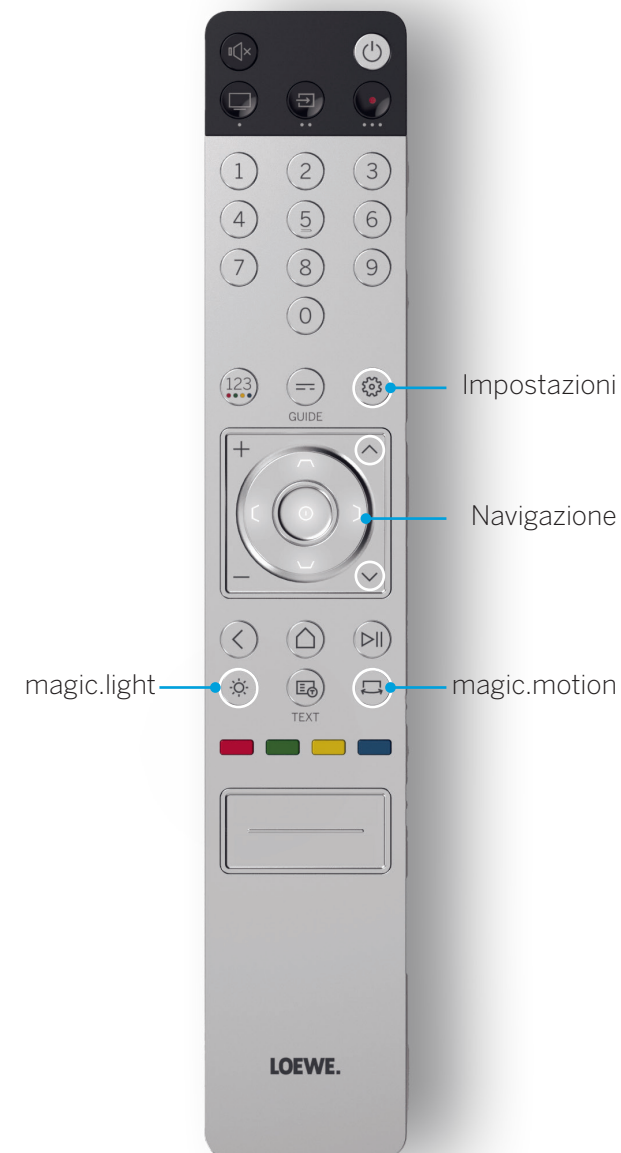

L'angolo perfetto.

## Loewe magic.motion

Con magic.motion è possibile ruotare il dispositivo grazie al supporto motorizzato opzionale Loewe con la sola spinta di un pulsante.

Il tasto magic.motion  del telecomando Loewe stellar abilita questa funzione.

---



 Premi il tasto magic.motion.

---







 Premi i tasti di direzione per ruotare la TV. Angolo di rotazione max: 45°

---

### Configurazione della rotazione.

Contemporaneamente premi il tasto magic.motion  e il tasto delle impostazioni  per cinque secondi. Si sente un breve suono. La modalità di configurazione adesso è attiva.

Premendo i tasti di direzione , è possibile ruotare la TV in entrambe le direzioni.

1. Tieni premuto il tasto di direzione  per ruotare il dispositivo completamente a sinistra. Premi  per salvare questa posizione. Adesso sentirai due brevi suoni.
2. Tieni premuto il tasto di direzione  per ruotare il dispositivo completamente a destra. Premi  per salvare questa posizione. Adesso sentirai tre brevi suoni.
3. Adesso tieni premuto di nuovo il tasto di direzione a sinistra e riporta il dispositivo alla posizione di spegnimento desiderata. Premi  per salvare anche questa posizione. Adesso sentirai quattro brevi suoni.
4. Infine, premi di nuovo , per confermare che questa è la posizione predefinita quando accendi e spegni il dispositivo.
5. Adesso sentirai un suono lungo. La modalità di configurazione ora è completa.



Riconoscimento ostacoli: magic.motion si arresta automaticamente, quando colpisce un ostacolo.



20 secondi senza alcun input annullano la configurazione.

Cose utili da conoscere.

## App e informazioni tecniche.

### Scarica l'app my Loewe.

Usa lo smartphone per scansionare il codice QR sotto e scaricare l'app raccomandata. "my Loewe" è il portale di ingresso al mondo Loewe e ti dà accesso a tutti i manuali utente per i tuoi prodotti Loewe.



### Informazioni tecniche.

Hai acquistato una TV con schermo OLED che risponde ai più elevati standard di qualità e la presenza di eventuali difetti ai pixel è stata esclusa. Nonostante la massima cura nella fabbricazione del display, non è possibile garantire al 100% per motivi tecnici che non vi siano errori ai subpixel. Tuttavia se questi effetti sono entro i limiti specificati dalla norma (ISO 9241-307, difetto classe II), non sono considerati difetti dell'apparecchio entro l'ambito della garanzia. I diodi organici a emissione di luce (OLED) sono una tecnologia delle immagini basata su pixel autoilluminanti che offrono vantaggi significativi in termini di qualità e prestazioni delle immagini. In determinati casi l'esposizione persistente monolaterale al materiale OLED può provocare aberrazioni permanenti e irreversibili dell'immagine. Tali problemi di immagine residua si verificano quando la TV visualizza un'immagine statica come sottotitoli, maxischermo, presentazioni o sequenze video in un loop infinito, visualizzazioni statiche su un monitor di presentazioni o videogiochi. Anche barre nere su alcuni formati di schermo possono portare a problemi di immagini residue. È importante sottolineare che questi problemi di immagini residue non rappresentano un difetto ai sensi della garanzia. Se le immagini statiche sono visualizzate troppo a lungo, la TV riduce automaticamente il contrasto o passa alla modalità screen saver. All'utilizzo successivo del dispositivo si torna allo stato normale. In condizioni di visualizzazione normale non ci sono

tali problemi di immagini residue. Per mantenere la qualità elevata della visualizzazione dell'immagine sul lungo termine, la TV OLED di Loewe si calibra a intervalli regolari.

### Dischi rigidi USB collegati.

Scollegare la TV dalla rete durante il funzionamento o una interruzione accidentale dell'alimentazione (ad es. mancanza di corrente) può portare a danni al sistema dei file del disco rigido e quindi alla perdita delle trasmissioni registrate. Non scollegare mai il dispositivo di memoria USB dalla TV. Raccogliamo di mettere la TV in modalità stand-by prima di scollegarla. Loewe non si assume la responsabilità della perdita di dati memorizzati nel disco rigido integrato nella TV.

### Aggiornamenti software.

Le ultime versioni software possono essere scaricate dal sito web Loewe (nell'elenco sotto) e installate sulla TV usando una chiave USB. Se la TV è collegata a Internet, puoi aggiornarla direttamente da Internet. Maggiori informazioni sugli aggiornamenti del software sono disponibili nel manuale utente che è disponibile per il download dal sito web Loewe. Non si può garantire che i modelli Loewe funzioneranno sempre dall'inizio con tutte le periferiche collegate.

### Dichiarazione di non responsabilità per i servizi digitali.

Le nostre TV sono "prodotti con elementi digitali", le cui funzioni principali, come ricezione TV via cavo o satellite o riproduzione di DVD/Blu-ray mediante un lettore collegato alla TV, possono,

in linea di principio, essere usate anche senza questi elementi digitali. Gli elementi digitali disponibili per il dispositivo includono, ma non sono limitati a, app, giochi, musica, servizi video e altri programmi, nonché piattaforme che consentono di scaricare e/o accedere ad altre app. I servizi, i contenuti e/o gli elementi menzionati sopra, nonché le piattaforme server richieste per gli stessi, a cui si accede sullo sfondo attraverso Internet, sono offerti e/o forniti da fornitori terzi. Nota l'utente finale e/o i termini e le condizioni di questi fornitori terzi, che devi accettare in un secondo momento, in particolare quando installi la TV per la prima volta ma anche quando usi i servizi di terzi. Questa accettazione crea una relazione contrattuale diretta tra te e quel fornitore terzo di servizi in merito all'uso dei rispettivi elementi digitali, servizi e/o contenuti. In qualità di fabbricante della TV, Loewe Technology GmbH non ha influenza sulla fornitura di elementi digitali, servizi e contenuti, sulla loro qualità, sulla presentazione visiva, sulla fornitura di aggiornamenti e, in particolare, sulla fine del servizio di questi elementi digitali, servizi e contenuti. D'altra parte, durante la vita della TV, i nuovi elementi digitali, i servizi e/o i contenuti possono anche essere offerti sul dispositivo senza il tuo consenso regolare. Questi elementi digitali, servizi e/o contenuti aggiuntivi derivano, tra l'altro, da progressi tecnologici e requisiti generali del mercato. Tuttavia non c'è alcun obbligo di fornire nuovi elementi digitali, servizi e/o contenuti. In particolare non c'è obbligo di fornire un ricambio o un successore dopo la fine del servizio di un elemento digitale, un servizio o un contenuto. Ti preghiamo di rivedere i termini e le condizioni dell'utente finale applicabili a un determinato dispositivo.

## Dichiarazione.



Loewe Technology GmbH conferma che questo prodotto è conforme ai requisiti essenziali della Direttiva 2014/53/UE, così come alle altre direttive UE pertinenti.

Nella gamma di frequenza da 5150 a 5350 Mhz questa TV può essere usata solo all'interno nei seguenti Paesi:

Austria, Belgio, Bulgaria, Croazia, Cipro, Repubblica Ceca, Danimarca, Estonia, Finlandia, Francia, Germania, Grecia, Ungheria, Irlanda, Italia, Lettonia, Lituania, Lussemburgo, Malta, Paesi Bassi, Polonia, Portogallo, Romania, Slovacchia, Slovenia, Spagna, Svezia, Regno Unito.

Qui puoi trovare la dichiarazione di conformità completa nella selezione del prodotto:

**[www.loewe.tv/eu/en/service/support](http://www.loewe.tv/eu/en/service/support)**

## Stampa.

Loewe Technology GmbH,  
Industriestraße 11  
96317 Kronach, Deutschland  
[www.loewe.tv](http://www.loewe.tv)

Tribunale del Registro: Frankfurt am Main, HRB 117013  
Rappresentante: Aslan Khabliev

Le informazioni contenute in questo documento possono essere sottoposte a modifica senza preavviso. Tutti i diritti riservati, incluso traduzione, modifiche tecniche ed errori.







# Loewe stellar. Made in Germany.

## Bienvenido.

Muchas gracias por elegir Loewe stellar. Nos complace darle la bienvenida como cliente. Diseño, innovación y tecnología punta: ha elegido un aparato que reúne todas estas cualidades en un producto de primera calidad. Este modelo de televisor OLED de Loewe cautiva a su público por la tecnología de pantalla más moderna, un hardware de alto rendimiento y un nuevo lenguaje de diseño.

### Loewe stellar se fabrica en Alemania.

Cada detalle de este producto refleja la dedicación y la artesanía que distinguen Loewe y a sus empleados durante más de 100 años. Disfrute del exclusivo concepto de iluminación de Loewe stellar y convierta cada instante con esta extraordinaria línea de productos en un momento mágico. La función dr+ de canal doble de Loewe con triple sintonizador brinda una nueva experiencia televisiva: disfrute de multivisión y multigrabación con una calidad impecable.

Para los entusiastas de los juegos, stellar ofrece compatibilidad total con HDMI 2.1 y Ultra HD a 144 Hz VRR, para disfrutar de una experiencia de juego superrápida y sin interrupciones. Nuestra amplia gama de aplicaciones de streaming y servicios de vídeo a la carta, basados en el sistema operativo Tizen, garantiza entretenimiento para todos.

Lea atentamente estas instrucciones. Para disfrutar durante mucho tiempo de su producto Loewe, tenga en cuenta las instrucciones de seguridad que se adjuntan por separado. Si tiene alguna duda o necesita ayuda, el Servicio de atención al cliente de Loewe está siempre a su disposición.



En esta sección del manual de usuario encontrará información básica sobre cómo instalar su televisor Loewe. Tras encenderlo por primera vez, una intuitiva guía de puesta en marcha le guiará por el proceso de configuración.

En la página web de Loewe puede descargarse un manual electrónico completo. En él se describen detalladamente las funciones y características de su nuevo televisor Loewe.

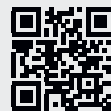

[www.loewe.tv](http://www.loewe.tv)

### Índice.

Bienvenido	125
Símbolos y placa de características.	126
Paquete de entrega.	127
Descripción general del televisor.	128
Primeros pasos: instalación del televisor.	130
Descripción general - Mando a distancia.	132
Primeros pasos - Mando a distancia.	134
Primeros pasos - Configuración inicial.	136
Pantalla de inicio.	140
Guía electrónica de programas.	141
Multigrabación.	142
Loewe magic.light	144
Loewe magic.motion	145
Aplicaciones e información técnica.	146
Declaración.	147
Impresión.	147

Símbolos y su significado.

## Símbolos y placa de características.

Este manual de usuario contiene numerosos símbolos, cuyo significado se explica en esta página. Lea atentamente esta sección y tenga en cuenta su significado.

La placa de características contiene información importante sobre el aparato:

- Nombre del aparato
- Tipo de aparato
- Número de artículo
- Número de serie



Las advertencias llaman la atención sobre cuestiones que pueden poner en peligro su salud o su vida, o la salud o la vida de otras personas. Presta atención a las advertencias.



Los avisos medioambientales contienen información sobre acciones o eliminación respetuosa con el medio ambiente. Preste atención a la información medioambiental.



Sugerencias y consejos generales en relación con el aparato o una aplicación de este.



Los avisos electrónicos llaman la atención sobre peligros que, de ignorarse, podrían dañar el aparato o poner en peligro su salud o su vida.



Las advertencias de peligro de rotura indican que existe riesgo de daños en el aparato o de lesiones. Preste atención a las advertencias de peligro de rotura.

### Ubicación de la placa de características

El adhesivo con el número de modelo y la tensión de funcionamiento se encuentra en la parte posterior del televisor.

Ejemplo de placa de características:



**stellar.65**

Ultra HD / OLED / CI+ / DR+

Art.No. 63470 B 10 Ser.No. 00001 / 3463

CH-TYP SL950

220-240V~ 50/60Hz 450 W



**LOEWE.**

Loewe Technology GmbH  
Industriestraße 11  
D-96317 Kronach

Manufactured  
in Germany

Todo lo que necesita.

## Paquete de entrega.

Asegúrese de que todo el contenido del embalaje y la caja de bienvenida de Loewe están presentes. Si falta algún componente, póngase en contacto con su distribuidor o con el Centro de atención al cliente de Loewe.

### Índice.

- Loewe quick start guide
- Manual de instrucciones (este documento)
- Loewe stellar
- Soporte
- Cable de alimentación
  
- Caja de bienvenida Loewe
  - Loewe remote stellar
  - Loewe remote stellar mini
  - Pilas tipo AAA
  - Tabla de datos técnicos de stellar
  - Instrucciones de seguridad de Loewe OLED
  - Instrucciones de montaje del soporte
  - Kit de montaje para el soporte



Parte frontal.

## Descripción general del televisor.



① Loewe signature.ring

LED de estado del televisor

- En espera
- Televisor encendido: panel encendido
- Televisor encendido: panel apagado
- Televisor en espera: actualizar OLED
- Grabación activa
- Reproducción en diferido activa

② Soporte de mesa Loewe stellar\*

③ Loewe magic.light

④ Barra de sonido

⑤ Pantalla OLED

⑥ Loewe signature.flag

\*En función del modelo y el tamaño.



## Parte posterior.



①	AC-IN	Alimentación: 220-240 V - 50/60 Hz
②	LAN*	Conexión a la red RJ-45
③	HDMI 1	HDMI 2.1 con salida de audio eARC
④	HDMI 2	Entrada HDMI 2.1
⑤	HDMI 3	Entrada HDMI 2.1
⑥	USB-A	USB 2.0 - 5V $\overline{=}$ , 2000 mA máx.
⑦	USB-C	USB 3.1 - 5V $\overline{=}$ , 1000 mA máx.
⑧	ANT SAT	Toma de satélite - DVB-S/S2 HD
	SUB	13/18V, 400 mA
⑨	ANT SAT	Recepción por satélite DVB-S/S2 HD
	MAIN	13/18V, 400 mA
⑩	ANT TV	Antena terrestre/televisor DVB-C/T/T2 HD
⑪	Common Interface	CI+ V1.4
⑫	HDMI 4	Entrada HDMI 2.1
⑬	Salida de audio Toslink	Toma de salida de audio de 3,5 mm/ TOSLINK
⑭	USB-A	USB 2.0 - 5V $\overline{=}$ , 2000 mA máx.
⑮	USB-C	USB 3.1 - 5V $\overline{=}$ , 1000 mA máx.

\*Se recomienda utilizar un cable LAN Cat5 sin blindaje..

Desembalaje y conexión.

# Primeros pasos: instalación del televisor.



## 1. Desembalaje del televisor.

Si aún no ha extraído el televisor de la caja, siga los sencillos pasos de la guía de inicio rápido. Continúe con el paso 2 de esta guía, una vez que haya fijado bien el televisor al soporte.

 Preste atención a las instrucciones de seguridad y a las especificaciones técnicas.

 Esta información es necesaria para la instalación y el funcionamiento seguros del televisor.



## 2. Conexión de los cables de antena.

Conecte el cable del satélite o de la antena. Los puertos etiquetados se encuentran en la parte posterior del televisor. Para exponer los puertos, retire con cuidado las tapas. Las tapas son fáciles de quitar. No se necesitan herramientas.

 Conecte primero los cables al televisor y, a continuación, al sistema de satélite o a la conexión por cable. Utilice la guía de cables del televisor y el soporte Loewe suministrados.

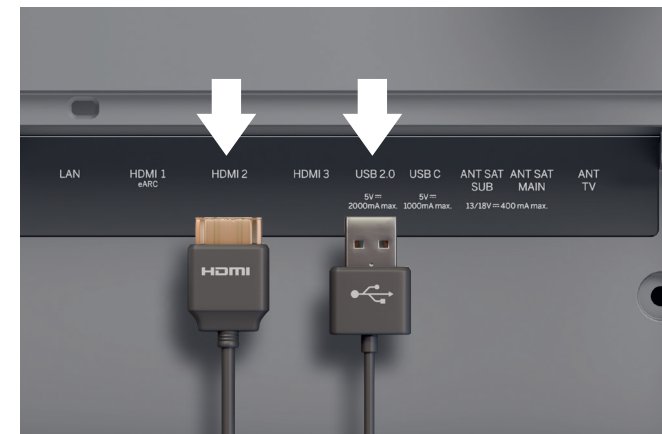

## 3. Conexión de aparatos adicionales.

Se pueden conectar aparatos adicionales, como videoconsolas o aparatos de almacenamiento, a través de las conexiones HDMI y USB. Encontrará más detalles en las páginas de ayuda del manual electrónico y en la página web de Loewe.

 Desenchufe todos los aparatos de la red eléctrica antes de conectarlos.



#### 4. Conexión a la red a través de LAN.

Puede conectar el televisor a una red LAN. La conexión a una red Wi-Fi se explica en la sección "Primeros pasos - Configuración inicial".

**i** Utilice un cable RJ45 CAT7 (10/100 Mbps) para conectarse a una red LAN.



#### 5. Audio a través de HDMI eARC.

Puede conectar una barra klang Loewe o su sistema de sonido al televisor mediante un cable HDMI. Para ello, utilice el puerto HDMI 1, que admite HDMI 2.1 con salida de audio eARC.

**i** Utilice un cable HDMI de "ultraalta velocidad", un conector de tipo A (no incluido), para obtener la máxima resolución de vídeo y eARC.

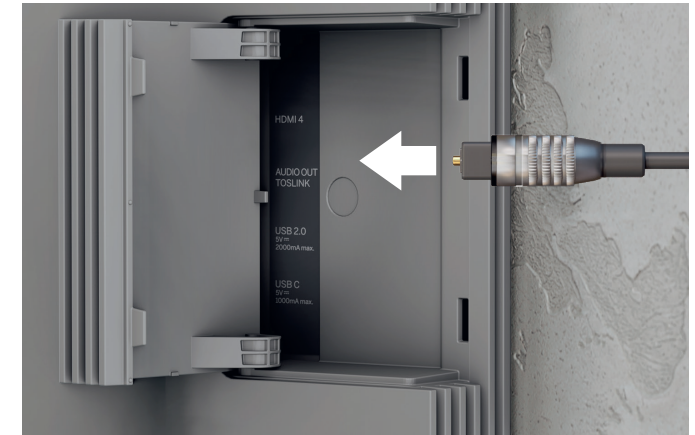

#### 6. Audio: mini TOSLINK/analógico.

Puede conectar un sistema de audio a través de TOSLINK al televisor. El tipo de conexión depende de su sistema de audio. Conecte la salida "AUDIO OUT TOSLINK" del televisor al sistema de audio.

Digital: utilice un cable óptico mini TOSLINK a TOSLINK.

Analógico: utilice un cable adaptador de RCA estéreo a conector para conectar el sistema de audio al televisor.

Dos por uno.

## Descripción general - Mando a distancia.

### Loewe **remote stellar**



Características adicionales

Loewe magic.light













Loewe magic.motion

	Encender/apagar	Encender/apagar el televisor
	Silenciar	Silenciar/activar sonido.
	Modo del televisor	Pulsar: televisión en directo; mantener pulsado: permite cambiar al aparato 1.
	Entrada	Pulsar: permite abrir la lista de aparatos; mantener pulsado: permite cambiar al aparato 2.
	Grabación	Pulsar: permite iniciar la grabación; mantener pulsado: permite cambiar al aparato 3.
	Programa	Permite seleccionar los canales directamente pulsando las teclas numéricas.
	Función 123	Televisión en directo: menú de grabación, gestor de programas, grabación, reproducción en diferido.
	Guía	Pulsar: permite abrir EPG; mantener pulsado: permite abrir la lista de canales.
	Ajustes	Pulsar: permite abrir ajustes; mantener pulsado: permite abrir todos los ajustes.
	Dirección	Permite cambiar el elemento o valor seleccionado dentro de un menú. Pulse izquierda/derecha/arriba/abajo para navegar.
	Selección	Permite seleccionar/iniciar el elemento actualmente seleccionado. Televisión en directo: permite mostrar los detalles del programa actual.
	Volumen	Permite aumentar o reducir el volumen.
	Canal	permite avanzar o retroceder de canal.
	Volver	Pulsar: permite volver al último menú; televisión en directo: permite retroceder de canal; mantener pulsado: permite cerrar el menú.
	Pantalla de inicio	Permite abrir la pantalla de inicio.
	Reproducir/poner en pausa	Permite reproducir/pausar medios o iniciar/pausar/continuar reproducción en diferido.
	magic.light	Permite abrir ajustes de magic.light. Vea la sección "Loewe magic.light".
	Teletexto	Permite abrir/cerrar el teletexto y el mediatexto.
	magic.motion	Permite activar el control motor de magic.motion. Véase la sección "Loewe magic.motion".
	Función	Teclas de función dependientes del menú.
	Aplicaciones	Teclas de acceso directo para iniciar aplicaciones y servicios de vídeo a la carta.

## Loewe **remote stellar mini**



 Característica adicional  
Comando de voz de audio

	Encender/apagar	Permite encender/apagar el televisor.
	Función 123	Permite introducir números y cambiar colores. Televisión en directo: menú de grabación, gestor de programas, grabación, reproducción en diferido.
	Micrófono	Permite pulsar para activar el control por voz.
	Ajustes	Pulsar: permite abrir ajustes.
	Dirección	Permite cambiar el elemento o valor seleccionado dentro de un menú. Pulse izquierda/derecha/arriba/abajo para navegar.
	Selección	Permite seleccionar/iniciar el elemento actualmente seleccionado. Televisión en directo: permite mostrar los detalles del programa actual.
	Volver	Pulsar: permite volver al último menú; televisión en directo: permite retroceder al programa; mantener pulsado: permite cerrar el menú.
	Pantalla de inicio	Permite abrir la pantalla de inicio.
	Reproducir/poner en pausa	Permite reproducir/pausar medios o iniciar/pausar/continuar reproducción en diferido.
	Volumen	Permite aumentar o reducir el volumen.
	Canal	permite avanzar o retroceder de canal.
	Vídeo a la carta	Teclas de acceso directo para iniciar aplicaciones y servicios de vídeo a la carta.



Inserción y cambio de las pilas.

## Primeros pasos - Mando a distancia.

1. Abra el compartimento de las pilas situado en la parte posterior del mando a distancia. Deslice hacia abajo la tapa del compartimento de las pilas y retírela. El compartimento de las pilas queda al descubierto.

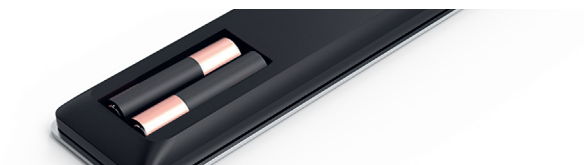

2. Alinee la primera pila con el borne positivo como se muestra en la imagen del mando a distancia.

 Asegúrese de que los terminales (+ y -) están correctamente alineados.

 Compruebe que las pilas están bien sujetas.

3. Vuelva a colocar la tapa y cierre el compartimento de las pilas.

Ahora, pruebe el mando a distancia para asegurarse de que funciona correctamente. Si no es así, repita los pasos.





 La inserción de las pilas funciona de forma idéntica para ambos mandos a distancia.

 Utilice exclusivamente pilas AAA LR03 (alcalinas de manganeso) estancas. Se necesitan dos pilas por mando a distancia.





## Emparejamiento del Loewe remote stellar mini.

Al encender el televisor  por primera vez, se conecta automáticamente al mando Loewe remote stellar mini. Para emparejar manualmente el mando a distancia con el televisor, diríjalo hacia la parte frontal del aparato y pulse simultáneamente las teclas  y  durante tres segundos.





 No es necesario emparejar el mando Loewe remote stellar.

 Mantenga las pilas fuera del alcance de los niños. No exponga las pilas al sol ni las arroje al fuego.

 Deseche las pilas vacías de forma respetuosa con el medio ambiente. Para obtener más información, consulte el capítulo Medio ambiente/aviso legal.

## Programación de los botones del aparato.

Además de la función directa, la tecla  del televisor y las teclas  y  del aparato ofrecen también la posibilidad de manejar otros aparatos Loewe con solo pulsar un botón. Esta función permite controlar sin problemas otros aparatos de audio Loewe, reproductores Blu-ray y altavoces de otros fabricantes. Los puntos debajo de cada tecla simbolizan la función respectiva.

 Televisión en directo (pulsar 1 segundo),  
Modo: televisión Loewe (pulsar 3 segundos)

 Entrada (pulsar un segundo),  
Modo: Loewe klang mr 1/3/5 (pulsar 3 segundos)

 Grabar (pulsar 3 segundos),  
Modo: Loewe klang bar 3/5 mr (pulsar 3 segundos)

## Programación de otros aparatos.

Estas teclas también pueden asignarse a otros aparatos. Por ejemplo, si tiene un reproductor Blu-ray o un receptor por cable vinculado a uno de los botones de aparato, puede controlar cómodamente el volumen y

el silencio desde el mando a distancia. Esto hace que el manejo de su sistema de entretenimiento doméstico sea aún más fácil e intuitivo. Encontrará más información sobre la programación del mando a distancia stellar Loewe en la página web de Loewe.

## Activación del anillo LED y ajuste del brillo.



Mantenga pulsada la tecla  y una de las teclas numéricas 1, 2, 3, 4 o 5 al mismo tiempo durante 3 segundos para cambiar el brillo de los LED de las teclas de dirección.

"1" corresponde al ajuste de brillo más bajo, "5" al más alto. Cambie la iluminación de las teclas a su gusto.

Rápido y sencillo.

## Primeros pasos - Configuración inicial.

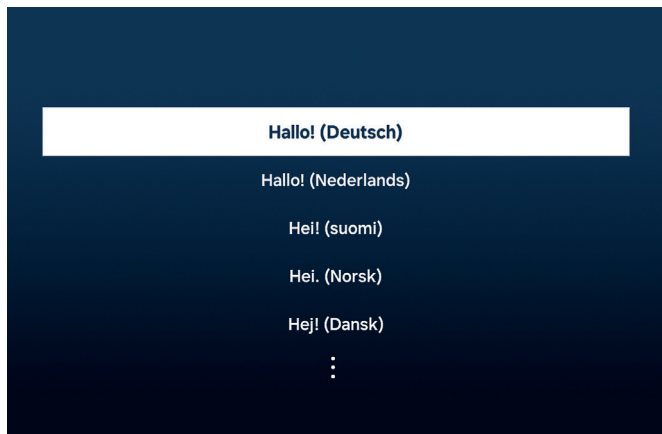

### Seleccione el idioma del menú.

En primer lugar, selecciona el idioma del menú. Cambie el idioma con las teclas de dirección . Confirme con .



### Inicie la configuración inicial.

Loewe stellar incluye una guía para la configuración inicial. Siga sus instrucciones.

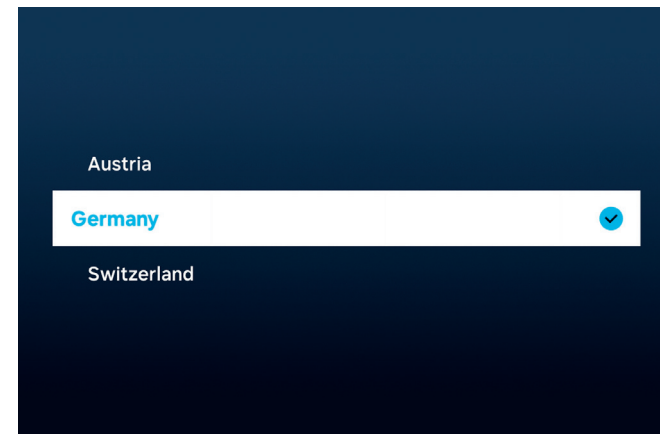

### Selección de su país.

Seleccione ahora su país o región con las teclas de dirección . Confirme con .



Preste atención a las instrucciones de seguridad y a las especificaciones técnicas de este televisor.



La apariencia de la interfaz de usuario puede cambiar tras una actualización de software.

Centro de atención al cliente de  
Loewe  
[www.loewe.tv](http://www.loewe.tv)



Los servicios disponibles pueden variar en función de la región seleccionada.

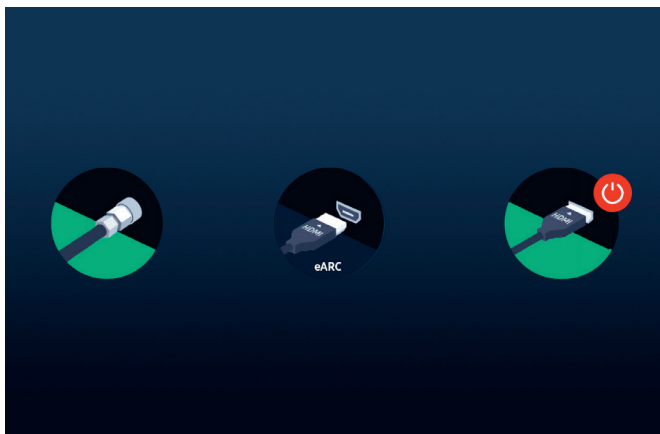

## Reconocimiento automático de la conexión.

Loewe stellar reconoce automáticamente todas las antenas conectadas y los aparatos conectados a través de USB o HDMI.

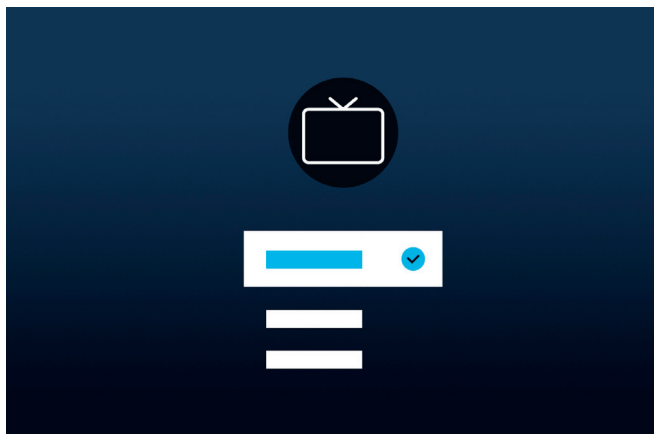

## Recepción del televisor y tipo de programa.

Una vez reconocida la señal terrestre o por cable, seleccione el tipo de recepción del televisor y de programa. En el siguiente paso se guardarán automáticamente todos los canales disponibles.

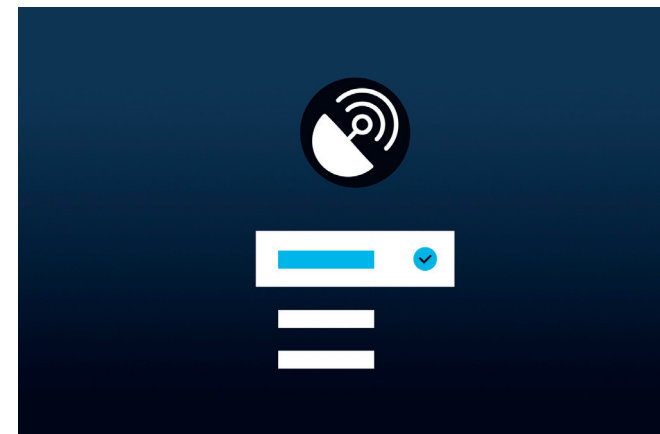

## Señal de satélite.

Si hay señal de satélite disponible, puede realizar ajustes adicionales en este menú.

Ajuste el tipo de programa, la selección de satélite, el LNB, el satélite y la gama de búsqueda. Si utiliza SAT MAIN y SAT SUB, puede elegir entre dual o principal en este menú.



Compruebe si todos los aparatos están encendidos.

Ya casi ha terminado.

## Primeros pasos - Configuración inicial.

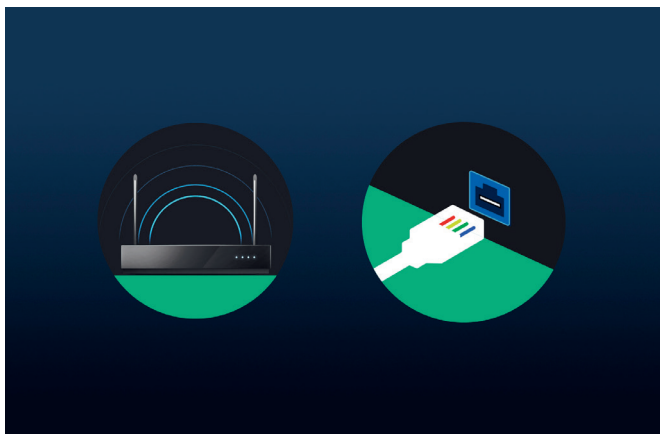

### Seleccione una red.



Para aprovechar al máximo un televisor inteligente moderno, se necesita una conexión a Internet. Puede conectar su televisor Loewe a una red mediante WLAN (inalámbrica) o LAN (por cable).

**WLAN** Explicación en el paso siguiente. Tenga preparadas sus credenciales WLAN.

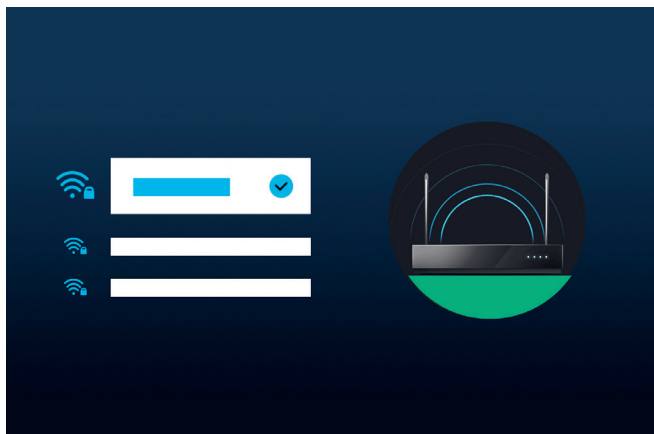
**LAN** Asegúrese de que un extremo del cable de red está conectado al televisor y el otro al enrutador.



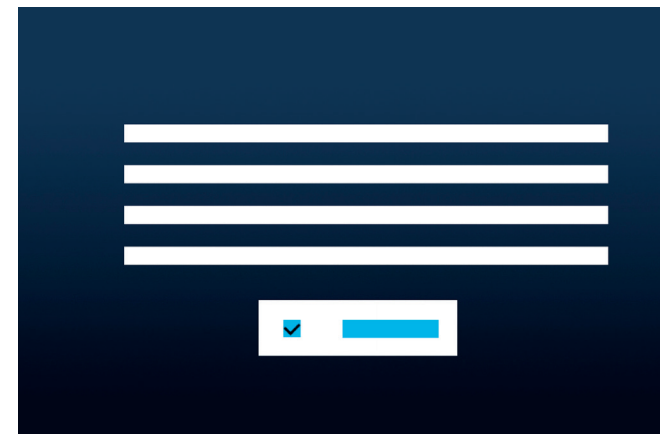

### Conexión a WLAN.

Cuando utilice la WLAN, se le pedirá que introduzca su contraseña. Utilice las teclas de dirección  y la tecla de selección , para seleccionar números y letras. Confirme con .



### Condiciones generales, política de privacidad.

Para utilizar todas las funciones del aparato, debe aceptar los términos y condiciones, y la política de privacidad de Smart Hub. Para ello, pulse el botón de selección  y haga clic en "Estoy de acuerdo con todo".

 Sin la aceptación de las condiciones y la política de privacidad, no se puede garantizar el funcionamiento de algunos servicios.



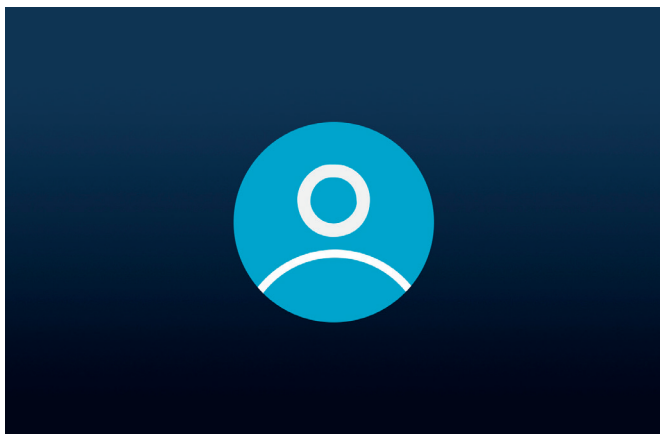

## Creación de una cuenta de usuario.

Paso opcional: pulse la tecla de dirección  para saltar este paso. Acceda a una cuenta Samsung existente o crea una nueva. El uso de una cuenta Samsung le permite beneficiarse de las mejores funciones de su aparato inteligente y lo mantiene siempre actualizado.

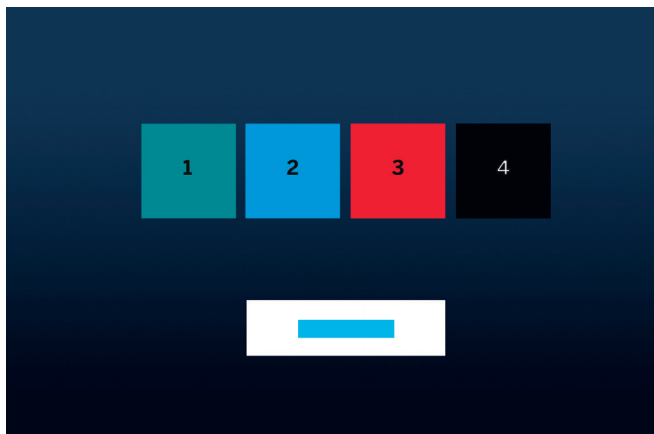

## Personalización de la barra de tareas.

En este paso puede guardar y ordenar las aplicaciones en la barra de tareas. Algunas aplicaciones ya vienen preinstaladas. Las aplicaciones también se pueden personalizar posteriormente en el Smart Hub.

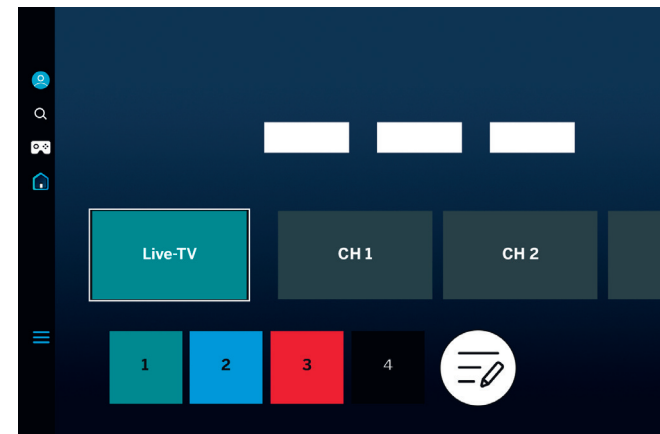

## Pantalla de inicio.

Una vez que aparezca la pantalla de inicio, se habrá completado la configuración inicial. Es hora de empezar su experiencia televisiva. Abra la televisión en directo o su aplicación favorita. Esperamos que disfrute de su nuevo televisor Loewe.

 Se necesita una cuenta de usuario para utilizar las aplicaciones o el vídeo a la carta.

Smart-Hub.

## Pantalla de inicio.

El Smart Hub es la pantalla de inicio de su televisor. Desde aquí puede iniciar aplicaciones, servicios o sumergirse en la televisión en directo.

 Pula la tecla de inicio del mando a distancia para volver inmediatamente a esta pantalla.

Tiene a su disposición las siguientes opciones:

 Perfil del usuario: permite acceder al perfil de usuario.

 Buscar: permite buscar canales, películas o aplicaciones. Control por voz con el Loewe remote stellar mini.

 Gaming-Hub: permite transmitir juegos directamente.

 Pantalla de inicio: permite cambiar la disposición de las aplicaciones.

 Aparatos conectados /Ajustes 

 Permite cambiar los ajustes de privacidad

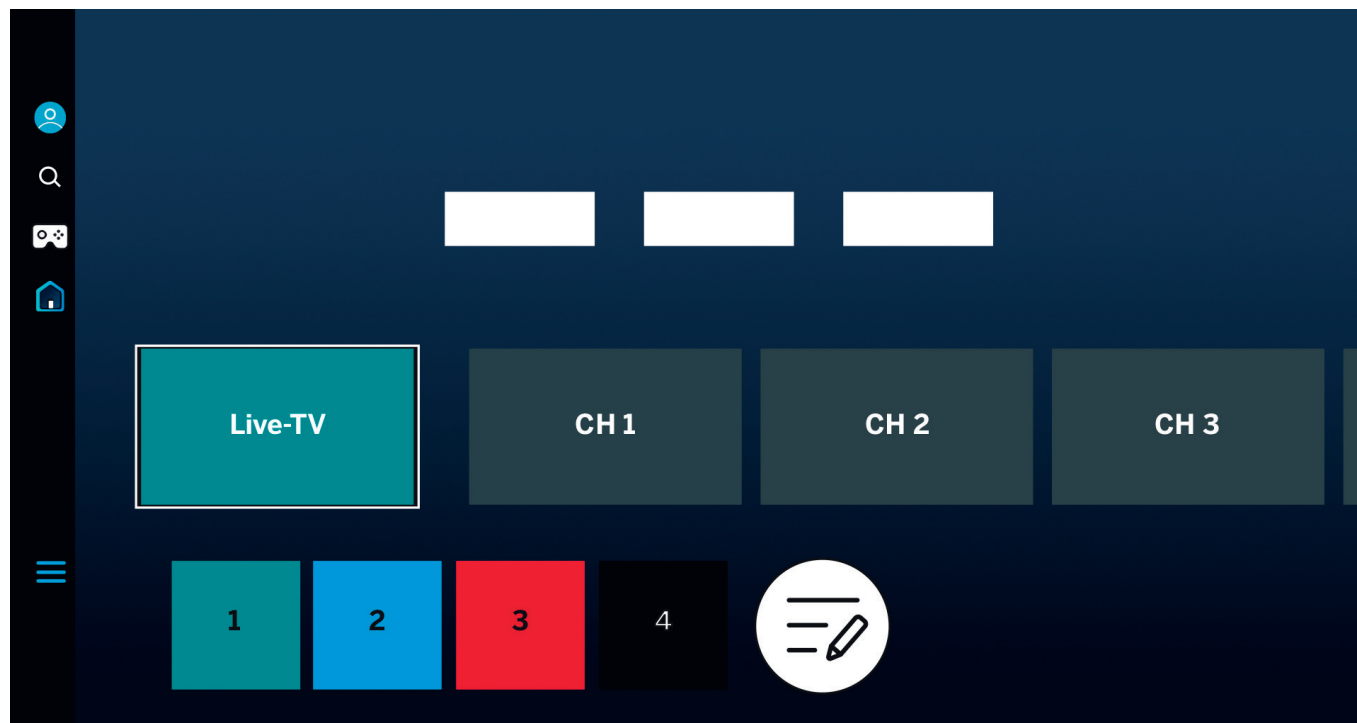

Permite utilizar las teclas de dirección  para navegar. Se selecciona la ficha resaltada y ampliada.

Inicie las aplicaciones instaladas, los servicios o el televisor en directo instalados pulsando la tecla de selección . A la izquierda se incluyen más opciones de configuración: perfil de usuario, búsqueda, modo ambiente, centro de juegos, medios y política de privacidad.

 La visualización y la información pueden variar según el país y la región.

De un vistazo.

# Guía electrónica de programas.

La guía electrónica de programas (EPG) proporciona información sobre la programación televisiva actual y futura. También puede utilizarla para programar grabaciones.

 Pulse la tecla guía del mando a distancia para abrir la guía de programación.

Tiene a su disposición las siguientes opciones:

 Editar filtros de canal.

 Mostrar solo canal de televisión.

 Mostrar solo emisoras de radio.

 Editar canales.

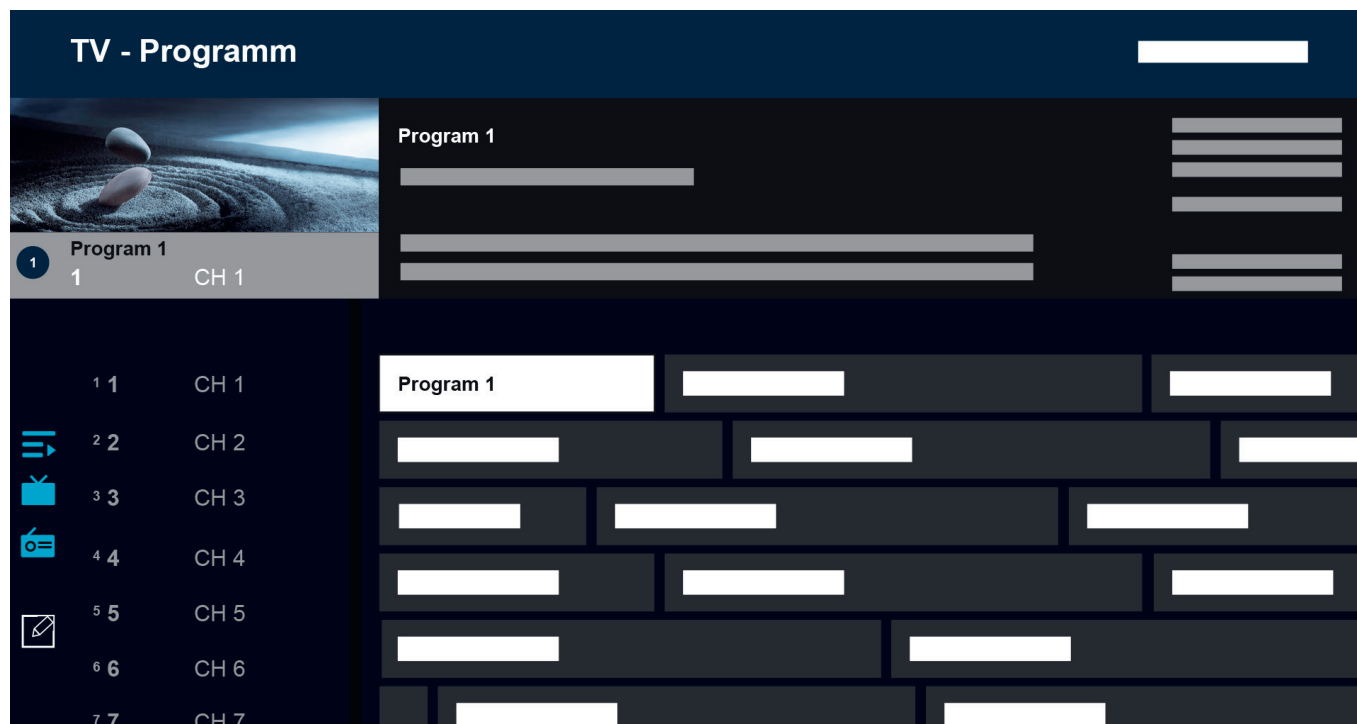

Características adicionales de la EPG:

- Previsualización de imágenes en directo.
- Información sobre el programa actual.
- Visualización de fecha y hora.
- Previsualización de todos los canales disponibles.
- Descripción general del mando Loewe remote stellar mini.

Más información disponible en el manual electrónico del sistema operativo Tizen.

 La visualización y la información pueden variar según el país y la región.

## Grabación con dr+.

# Multigrabación.

Grabe programas con Loewe stellar, programe una grabación o utilice la reproducción en diferido para ver un programa de televisión en directo más tarde. Las grabaciones se almacenan automáticamente en el disco duro integrado. Si lo desea, también puede utilizar un aparato de almacenamiento USB externo adecuado.

## Grabación instantánea.

Seleccione un programa de televisión en directo que desee grabar y pulse la tecla de grabación (●) o (123). Seleccione "Grabación (●)" en el siguiente menú emergente para comenzar.

## Programación de grabaciones.

Abra la EPG y seleccione el programa que desea grabar. Confirme con (●) y seleccione "Programar grabación" en el siguiente menú emergente para comenzar. Las grabaciones manuales pueden programarse en el gestor de programas.



## Responsable de grabación y programación.

El gestor de grabaciones y programas ofrece una visión general de las grabaciones pasadas y previstas.

## Grabaciones.

En el modo de televisión en directo, abra la lista de grabaciones disponibles pulsando (123) y seleccionando (●). Seleccione la grabación deseada con las teclas de dirección y confirme con (●) para reproducirla.

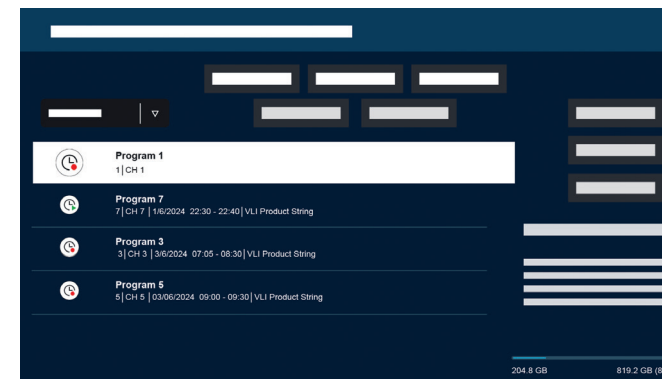

## Programación.

En el modo de televisión en directo, pulse (123) y seleccione (●) para obtener una vista general de todas las grabaciones programadas. El botón "Añadir grabación" permite programar grabaciones manuales y en serie.

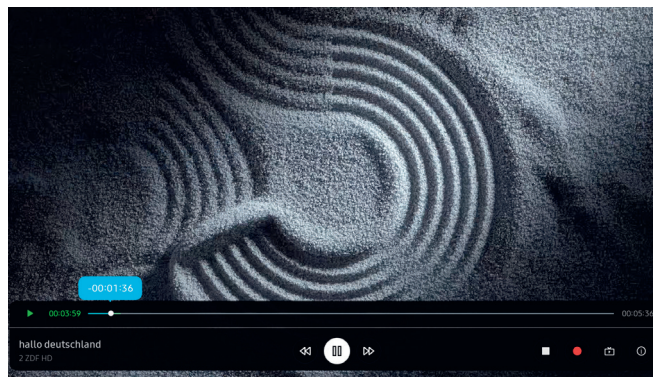
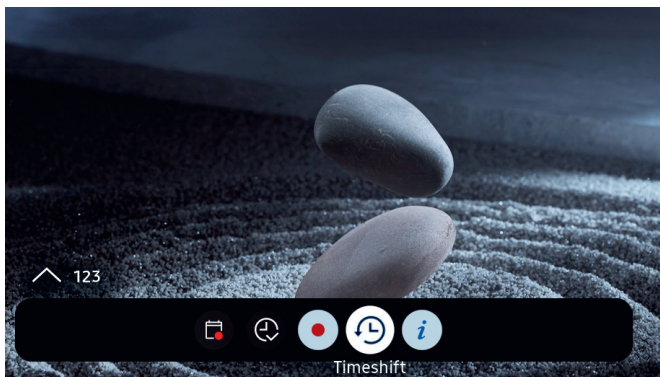

## Reproducción en diferido.

Pulse  para activar la reproducción en diferido.

Con la función de reproducción en diferido activa, puede poner en pausa un programa y reanudarlo más tarde, o incluso volver a ver secciones.

 Capacidad máxima de grabación: 90 minutos.

Pulse la tecla de dirección hacia abajo  para mostrar la barra de progreso en el menú de reproducción en diferido.

Utilice las teclas de dirección para navegar por el menú de reproducción en diferido.

## Menú de reproducción en diferido:

-  Reproducir/poner en pausa la reproducción en diferido.

---

-  Avance rápido.

---

-  Rebobinar.

---

-  Detener reproducción en diferido.

---

-  Iniciar grabación.

---

-  Volver a la televisión en directo. La reproducción en diferido permanece activa.

---

-  Información

Lea todas las instrucciones de seguridad antes de utilizar la función de reproducción en diferido, especialmente la sección "Discos duros USB conectados". Desconectar el aparato de la fuente de alimentación puede provocar la pérdida de datos.

Encontrará más información en el manual electrónico, apartado "Antes de grabar y utilizar la reproducción en diferido".





Una recepción brillante.

# Loewe magic.light

Cada Loewe stellar cuenta con una Loewe magic.light integrada. Utilice la banda LED discretamente oculta acentuar sutilmente la bienvenida y la despedida, o permita que subraye su película favorita en un cálido tono blanco.

Personalice magic.light en función de su gusto y estado de ánimo. Más información sobre esta función en esta sección.

 Activar los ajustes:  
Pulse la tecla magic.light y confirme con .

 Encienda o apague la banda luminosa.

 Ajuste el brillo con las teclas de dirección

 Ajuste la saturación con las teclas de programa.



 Ajuste el color con las teclas de dirección.





Blanco cálido: 100 % de saturación  
Blanco frío: 0 % de saturación

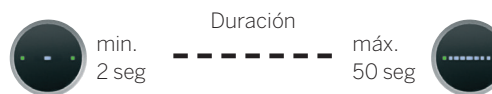

## Ajuste de la duración de la iluminación.

1. Mantenga pulsada la tecla magic.light  y la tecla de configuración  simultáneamente durante cinco segundos. La firma Loewe.ring mostrará una línea con siete puntos blancos. El número de puntos indica la duración de la iluminación:



2. Ahora puede ajustar la duración. La línea dentro de la firma.ring cambia al pulsar izquierda y derecha .
3. Pulse  para guardar la configuración.

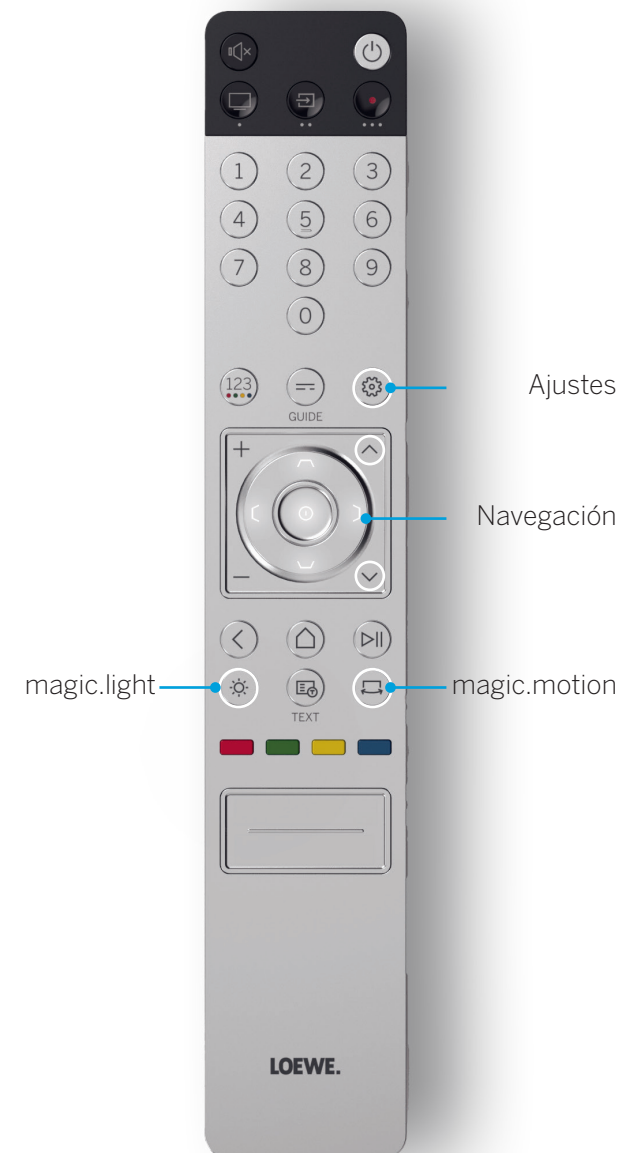

El ángulo perfecto.

## Loewe magic.motion

Gracias a magic.motion, es posible girar el aparato sobre el soporte de suelo motorizado opcional Loewe con solo pulsar un botón.

La tecla magic.motion  de su Loewe remote stellar activa esta función.

---



 Pulsa la tecla magic.motion.

---







 Pulse las teclas de dirección para girar el televisor. Ángulo de giro máx: 45°

---

### Configuración de la rotación.

Pulse simultáneamente la tecla magic.motion  y la tecla de configuración  durante 5 segundos. Oirá un tono corto. El modo de configuración está activo.

Pulsando las teclas de dirección , puede girar el televisor en cualquier dirección.

1. Mantenga pulsada la tecla de dirección izquierda  para girar el aparato hacia la izquierda. Pulse  para guardar esta posición. Oirá dos tonos cortos.
2. Mantenga pulsada la tecla de dirección derecha  para girar el aparato hacia la derecha. Pulse  para guardar esta posición. Oirá tres tonos cortos.
3. Mantenga pulsada de nuevo la tecla de dirección izquierda y vuelva a colocar el aparato en la posición de apagado deseada. Pulse  para guardar también esta posición. Oirá cuatro tonos cortos.
4. Por último, pulse  de nuevo, para confirmar que esta es la posición por defecto al encender y apagar el aparato.
5. A continuación oirá un tono largo. El modo de configuración ha finalizado.



Reconocimiento de obstáculos: magic.motion se detendrá automáticamente al chocar contra un obstáculo.



20 segundos sin ninguna entrada cancelarán la configuración.

Es bueno saberlo.

## Aplicaciones e información técnica.

### Descargue la aplicación my Loewe.

Utilice su smartphone para escanear el código QR que aparece a continuación y descargue la aplicación recomendada. "mi Loewe" es el punto de entrada al mundo Loewe y brinda acceso a todos los manuales de usuario de sus productos Loewe



### Información técnica.

Ha comprado un televisor con pantalla OLED que cumple las normas de calidad más estrictas y ha sido sometido a un control de píxeles. A pesar del máximo cuidado en la fabricación de la pantalla, no se puede garantizar completamente, por razones técnicas, que no se produzcan errores de subpíxel. Sin embargo, mientras estos efectos se encuentren dentro de los límites especificados en la norma (ISO 9241-307, clase de defecto II), no se consideran defectos del equipo en el sentido de la garantía. Los diodos orgánicos emisores de luz son una tecnología de imagen basada en píxeles autoiluminados que ofrecen importantes ventajas en términos de calidad de imagen y rendimiento. En determinadas circunstancias, la exposición unilateral persistente al material OLED puede provocar aberraciones permanentes e irreversibles de la imagen. Estos problemas de imagen residual se producen cuando el televisor muestra contenidos de imagen estática, como imágenes estáticas, subtítulos, teletipos, pases de diapositivas o secuencias de vídeo en bucle infinito, pantallas estáticas en un monitor de presentación o videojuegos. Las barras negras en algunos formatos de pantalla también pueden provocar pro-

blemas de imagen residual. Es importante subrayar que estos problemas residuales de imagen no constituyen defectos en el sentido de la garantía. Si se muestran imágenes estáticas durante demasiado tiempo, el televisor reduce automáticamente el contraste o pasa al modo de ahorro de pantalla. La próxima vez que el usuario utilice el aparato, este volverá inmediatamente a su estado normal. En condiciones normales de visualización, no hay problemas de imagen residual. Para mantener la alta calidad de la imagen a largo plazo, su televisor Loewe OLED se calibra a intervalos regulares.

### Discos duros USB conectados.

La desconexión del televisor de la red eléctrica durante el funcionamiento o una interrupción accidental del suministro eléctrico (por ejemplo, un corte de corriente) pueden provocar daños en el sistema de archivos del disco duro y, por tanto, la pérdida de las emisiones grabadas. No desconecte nunca el dispositivo de almacenamiento USB del televisor. Le recomendamos que ponga el televisor en modo de espera antes de extraerlo. Loewe no se hace responsable de la pérdida de datos almacenados en el disco duro integrado de su televisor.

### Actualizaciones del software

Las últimas versiones de software pueden descargarse de la página web de Loewe (abajo indicada) e instalarse en su televisor mediante una memoria USB. Si su televisor está conectado a Internet, puede actualizarlo directamente en línea. Encontrará más información sobre las actualizaciones de software en el manual de usuario, disponible para su descarga en

la página web de Loewe. No se puede garantizar que los modelos Loewe funcionen permanentemente desde el principio con todos los periféricos conectables.

### Cláusula de exención de responsabilidad de los servicios digitales.

Nuestros televisores son "productos con elementos digitales", cuyas funciones principales, como la recepción de televisión por cable o satélite o la reproducción de DVD/Blu-ray a través de un reproductor conectado al televisor, en principio también pueden utilizarse sin estos elementos digitales. Los elementos digitales disponibles en el aparato incluyen, entre otros, aplicaciones, juegos, música, servicios de vídeo y otros programas, así como plataformas que permiten descargar o acceder a aplicaciones adicionales. Los servicios, contenidos o elementos anteriormente mencionados, así como las plataformas de servidor necesarias para estos, a las que acceden en segundo plano a través de Internet, son ofrecidos o prestados por terceros. Tenga en cuenta las respectivas condiciones de uso o términos y condiciones de estos proveedores, que deberá aceptar posteriormente, en particular al instalar el televisor por primera vez, pero también al utilizar servicios de estos. Esta aceptación crea una relación contractual directa entre usted y los respectivos proveedores de servicios en relación con el uso de sus elementos digitales, servicios o contenidos. Como fabricante de televisores, Loewe Technology GmbH no tiene ninguna influencia sobre la puesta a disposición de elementos, servicios y contenidos digitales, así como sobre su calidad, presentación visual, puesta a disposición de actualizaciones y, en particular, el fin de la vida útil de estos

## Declaración.

elementos, servicios y contenidos digitales. Por otro lado, durante la vida útil del televisor, también pueden ofrecerse nuevos elementos digitales, servicios o contenidos en el aparato sin su consentimiento habitual. Estos elementos, servicios o contenidos digitales adicionales son el resultado, entre otras cosas, del progreso tecnológico y de las exigencias generales del mercado. Sin embargo, no existe ninguna obligación de proporcionar nuevos elementos, servicios o contenidos digitales. En particular, no existe ninguna obligación de proporcionar un sustituto o sucesor tras el fin de la vida útil de un elemento, servicio o contenido digital. Consulte los términos y condiciones aplicables a su aparato.



Loewe Technology GmbH confirma que su producto cumple los requisitos esenciales de la Directiva 2014/53/UE, así como otras directivas pertinentes de la UE.

En la gama de frecuencias de 5150 a 5350 Mhz, este televisor solo puede utilizarse en interiores en los siguientes países:

Alemania, Austria, Bélgica, Bulgaria, Chipre, Croacia, Dinamarca, Eslovaquia, Eslovenia, España, Estonia, Finlandia, Francia, Grecia, Hungría, Irlanda, Italia, Letonia, Lituania, Luxemburgo, Malta, Países Bajos, Polonia, Portugal, Reino Unido, República Checa, Rumanía y Suecia.

Aquí encontrará la declaración de conformidad completa en la selección de productos:

**[www.loewe.tv/eu/en/service/support](http://www.loewe.tv/eu/en/service/support)**

## Impresión.

Loewe Technology GmbH  
Industriestraße 11  
96317 Kronach, Alemania  
[www.loewe.tv](http://www.loewe.tv)

Tribunal de registro: Fráncfort del Meno, HRB 117013  
Representado por: Aslan Khabliev

La información contenida en este documento puede estar sujeta a cambios sin previo aviso. Reservados todos los derechos, incluidos los de traducción, modificaciones técnicas y errores.







Loewe stellar. Produzido na Alemanha.

## Bem-vindo(a).

Obrigado por ter escolhido a Loewe stellar. Alegremo-nos por tê-lo(a) como cliente. Design, inovação e tecnologia de ponta - escolheu um equipamento que reúne todas estas qualidades num produto sublime. Este modelo de TV OLED produzido pela Loewe cativa os seus espectadores através da tecnologia de monitor mais avançada, equipamentos de alto desempenho e uma nova linguagem de design.

Assim nasce um produto Loewe stellar.

Cada detalhe deste produto reflete a dedicação e a perícia que distingue a Loewe e os seus funcionários há mais de 100 anos. Desfrute do conceito único de iluminação da Loewe stellar e torne cada momento com esta linha de produto notável um momento mágico. A tecnologia dr+ de canal duplo da Loewe com um sintonizador triplo abre uma nova experiência de TV - desfrute da possibilidade oferecida pela função Multi View e de gravações múltiplas com uma qualidade irrepreensível.

Para os entusiastas de gaming, a stellar oferece compatibilidade total com HDMI 2.1 e Ultra HD @ 144 Hz VRR, proporcionando uma experiência de gaming super-rápida e imersiva. A nossa gama completa de apps de streaming e serviços de VOD, suportada pelo sistema operativo Tizen, assegura entretenimento para todos. Leia atentamente estas instruções. Para garantir que

usufrui plenamente do seu produto Loewe por um período duradouro, consulte as instruções de segurança anexadas em separado. Se tiver alguma questão ou se precisar de ajuda, a assistência ao cliente Loewe está sempre à sua disposição.



Nesta secção do manual do utilizador, irá encontrar informação essencial importante sobre como instalar a sua TV Loewe. Depois de ligar o televisor pela primeira vez, será acompanhado por um assistente de instalação intuitivo durante o processo de configuração.

Está disponível para download um manual eletrónico no site da Loewe. Este oferece descrições completas sobre as funções e funcionalidades da sua nova TV Loewe.



[www.loewe.tv](http://www.loewe.tv)

## Índice.

Bem-vindo(a)	149
Símbolos e chapa de tipo.	150
Conteúdo da embalagem.	151
Vistas gerais - TV.	152
Primeiros passos - instalação da TV.	154
Vista geral - Telecomando	156
Primeiros passos - Telecomando	158
Primeiros passos - Configuração inicial	160
Página inicial	164
Guia de programação	165
Gravações múltiplas	166
Loewe magic.light	168
Loewe magic.motion	169
Apps e informação técnica	170
Declaração	171
Edição	171

Símbolos e os seus significados.

## Símbolos e chapa de tipo.

Este manual do utilizador apresenta diversos símbolos, cujos significados são explicados nesta página. Leia atentamente esta seção e retenha os seus significados.

A chapa de tipo contém informação importante sobre o equipamento:

- Nome do equipamento
- Tipo de equipamento
- Número do artigo
- Número de série



Advertências que alertam sobre aspetos que podem constituir um perigo de vida ou para a saúde. Respeite todas as advertências.



Avisos ambientais que contêm informação sobre as ações ambientais corretas e a eliminação de uma forma ecologicamente responsável. Respeite toda a informação ambiental.



Sugestões e conselhos genéricos no âmbito do equipamento ou de uma aplicação do equipamento.



Avisos sobre sistemas elétricos/eletrónicos que alertam sobre perigos que, se ignorados, podem danificar o equipamento ou constituir um perigo de vida ou para a saúde.



Advertências que alertam sobre o risco de quebra que pode danificar o equipamento ou qualquer lesões físicas. Repeite todas as advertências sobre o risco de quebra.

Posição da chapa de tipo.

Na traseira do televisor, encontra-se o rótulo com o número do modelo e as tensões de alimentação.

Exemplo da chapa de tipo:



**stellar.65**

Ultra HD / OLED / CI+ / DR+

Art.No. 63470 B 10 Ser.No. 00001 / 3463

CH-TYP SL950

220-240V~ 50/60Hz 450 W



**LOEWE.**

Loewe Technology GmbH  
Industriestraße 11  
D-96317 Kronach

Manufactured  
in Germany

Tudo o que precisa.

## Conteúdo da embalagem.

Confirme que a embalagem contém todos os elementos, assim como a caixa de boas-vindas da Loewe. Se faltar algum elemento, contacte o vendedor do produto ou o centro de apoio ao cliente da Loewe.

### Conteúdos:

- Loewe quick start guide
- Manual do utilizador (este documento)
- Loewe stellar
- Suporte
- Cabo de alimentação
  
- Caixa de boas-vindas da Loewe
  - Loewe remote stellar
  - Loewe remote stellar mini
  - Pilhas do tipo AAA
  - Tabela de dados técnicos stellar
  - Instruções de segurança do OLED Loewe
  - Instruções de montagem do suporte
  - Kit de instalação para o suporte



Frente.

## Vistas gerais - TV.



① Anel de insígnia Loewe

LED de estado da TV

- Standby (espera)
- TV ligada: Ecrã ligado
- TV ligada: Ecrã desligado
- TV em espera: Atualização OLED
- Gravador ativo
- Timeshift ativo

② Suporte de mesa Loewe stellar \*

③ Loewe magic.light

④ Barra de som

⑤ Ecrã OLED

⑥ Insígnia Loewe

\*Dependendo da versão e do tamanho.

## Traseira.



①	Entrada AC	Ligação elétrica - 220-240 V - 50/60 Hz
②	LAN*	Ligação de rede RJ-45
③	HDMI 1	HDMI 2.1 com Saída áudio eARC
④	HDMI 2	Entrada HDMI 2.1
⑤	HDMI 3	Entrada HDMI 2.1
⑥	USB	USB 2.0 - 5V $\overline{=}$ , máx. 2000 mA
⑥	USB	USB 2.0 - 5V $\overline{=}$ , máx. 2000 mA
⑦	USB	USB 3.1 - 5V $\overline{=}$ , máx. 1000 mA
⑧	ANT SAT	Ficha de satélite - DVB-S/S2 HD
	SUB	13/18 V, 400 mA
⑨	ANT SAT	Receção de satélite DVB-S/S2 HD
⑬	PRINCIPAL	13/18 V, 400 mA
⑩	ANT TV	Antena terrestre/TV DVB-C/T/T2 HD
⑪	Common Interface	CI+ V1.4
⑫	HDMI 4	Entrada HDMI 2.1
⑬	Saída de áudio Toslink	Ficha de saída de áudio 3,5 mm/ TOSLINK
⑭	USB-A	USB 2.0 - 5V $\overline{=}$ , máx. 2000 mA
⑮	USB	USB 3.1 - 5V $\overline{=}$ , máx. 1000 mA

\*Recomenda-se a utilização de um cabo LAN Cat5 sem blindagem..



Desembalar e ligação.

## Primeiros passos - instalação da TV.



### 1. Desembalar o seu televisor.

Se ainda não retirou o seu televisor da embalagem, observe os passos simples indicados no guia de início rápido. Avance para o passo 2 neste guia, depois de ter instalado firmemente o televisor no respetivo suporte.

 Respeite as instruções de segurança e as especificações técnicas.

 Esta informação é necessária para garantir a segurança na configuração e utilização do seu televisor.



### 2. Ligar os cabos de antena.

Comece por ligar o cabo da antena ou do satélite. Na traseira do televisor, irá encontrar as entradas devidamente rotuladas. Para descobrir as entradas, levante cuidadosamente as tampas. Estas são de fácil remoção. Não são necessárias ferramentas.

 Comece por ligar os cabos ao televisor e, depois, o sistema de satélite ou a ligação por cabo. Utilize a guia do cabo no televisor e no suporte fornecido.

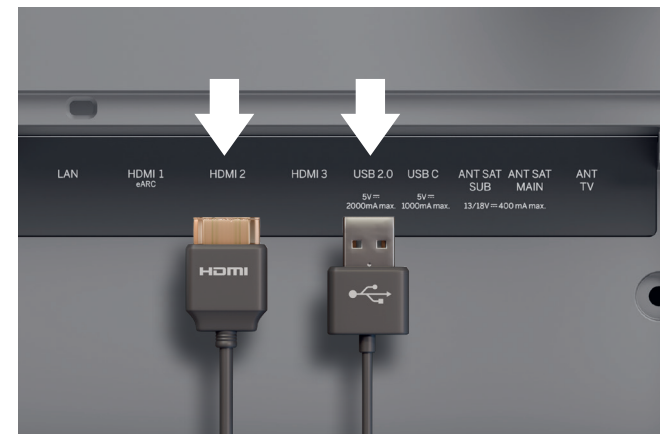

### 3. Ligar dispositivos adicionais.

Podem ser ligados dispositivos adicionais, como consolas de jogos ou dispositivos de armazenamento, através de HDMI e USB. Pode encontrar informação detalhada nas páginas de ajuda no manual eletrónico ou no site da Loewe.

 Antes de ligar qualquer dispositivo, desligue-o da tomada elétrica.



#### 4. Ligação de rede por cabo LAN.

Pode ligar o seu televisor a uma rede por cabo LAN. A ligação a uma rede por Wi-Fi é explicada na secção "Primeiros passos - configuração inicial" abaixo.

**i** Utilize um cabo RJ45 CAT7 (10/100 Mbps) para estabelecer a ligação a uma rede LAN.

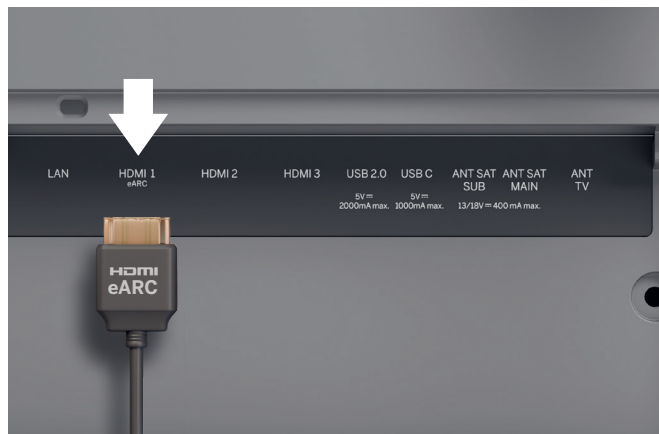

#### 5. Áudio por HDMI eARC.

Pode ligar o seu televisor a um sistema de som ou uma barra de som Loewe klang bar através de um cabo HDMI. Para tal, utilize a porta HDMI 1, a qual suporta HDMI 2.1 com saída de áudio eARC.

**i** Utilize um cabo HDMI de "ultra-alta-velocidade", com conector do tipo A (não incluído), para obter o melhor desempenho de resolução de vídeo e eARC.

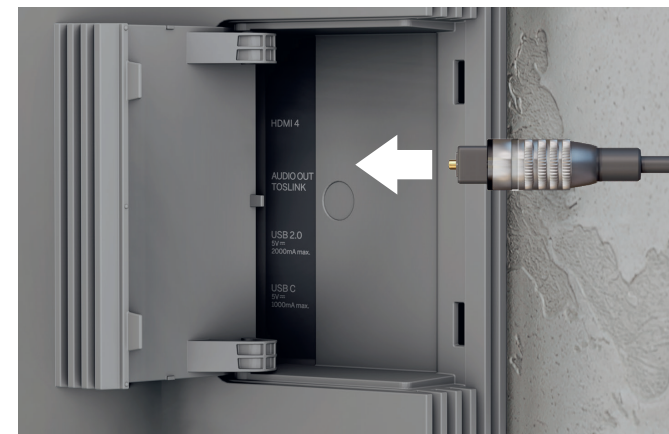

#### 6. Áudio: Mini-TOSLINK/analógico.

Pode ligar um sistema de áudio através da ligação TOSLINK ao televisor. O tipo de ligação depende do seu sistema de áudio. Ligue o sistema de áudio à saída "AUDIO OUT TOSLINK" no televisor.

Digital: Utilize um cabo ótico mini-TOSLINK para TOSLINK.

Analógico: Utilize um cabo adaptador ficha jack para RCA estéreo para ligar o sistema de áudio ao televisor.

Dois por um.

## Vista geral - Telecomando.

### Loewe **remote stellar**



Funcionalidades adicionais  
Loewe magic.light  
Loewe magic.motion

	Ligar/desligar	Liga ou desliga o televisor
	Silenciar	Silencia ou reativa o som.
	Modo da TV	Pressão breve: TV em direto. Pressão longa: Comuta para o dispositivo 1 TV.
	Entrada	Pressão breve: Abre a lista de dispositivos. Pressão longa: Comuta para o dispositivo 2.
	Gravação	Pressão breve: Inicia a gravação. Pressão longa: Comuta para o dispositivo 3.
	Programa	Permite seleccionar os canais directamente através das teclas numéricas.
	Função 123	TV em direto: Menu de gravação, gestor de programas, gravação, Timeshift.
	Guia	Pressão breve: Abre o guia de programação. Pressão longa: Abre a lista de canais.
	Definições	Pressão breve: Abre as definições. Pressão longa: Abre todas as definições.
	Setas	Permite mudar o elemento seleccionado ou um valor dentro de um menu. Prima para a esquerda/direita/cima/baixo para navegar entre os elementos.
	Selecionar	Seleciona/inicia o elemento seleccionado. TV em direto: Mostra a informação sobre o programa atual.
	Volume	Aumenta/diminui o volume.
	Canal	Canal seguinte/anterior.
	Retroceder	Pressão breve: Regressa ao menu anterior, TV em direto: Canal anterior. Pressão longa: Fechar o menu.
	Página inicial	Abre a página inicial.
	Reproduzir/pausa	Reproduz/pausa média ou iniciar/pausa/continuar Timeshift.
	magic.light	Abre as definições da função magic.light. Consulte a secção "Loewe magic.light".
	Teletexto	Abre ou fecha o teletexto.
	magic.motion	Ativa o comando do motor da função magic.motion. Consulte a secção "Loewe magic.motion".
	Função	Teclas de função conforme o menu.
	Apps	Teclas de atalho para iniciar apps e serviços de videoclube.

\*opcional

## Loewe **remote stellar mini**



Funcionalidade adicional  
Comando por voz de áudio

Ligar/desligar	Liga ou desliga o televisor.	
Função 123	Introduzir números e alterar cores. TV em direto: Menu de gravação, gestor de programas, gravação, Timeshift.	
Microfone	Prima para ativar o comando por voz.	
Definições	Pressão breve: Abre as definições.	
Setas	Permite mudar o elemento selecionado ou um valor dentro de um menu. Prima para a esquerda/direita/cima/baixo para navegar entre os elementos.	
Selecionar	Seleciona/inicia o elemento selecionado. TV em direto: Mostra a informação sobre o programa atual.	
Retroceder	Pressão breve: Regressa ao menu anterior, TV em direto: Programa anterior. Pressão longa: Fechar o menu.	
Página inicial	Abre a página inicial.	
Reproduzir/pausa	Reproduz/pausa média ou iniciar/pausa/continuar Timeshift.	
+/-	Volume	Aumenta/diminui o volume.
^/∨	Canal	Canal seguinte/anterior.
Videoclube	Teclas de atalho para iniciar apps e serviços de videoclube.	

Instalar e substituir as pilhas.

## Primeiros passos - Telecomando.

1. Abra o compartimento das pilhas na parte traseira do telecomando. Faça deslizar a tampa do compartimento das pilhas para baixo e, depois, levante-a para fora. O compartimento das pilhas fica assim aberto.

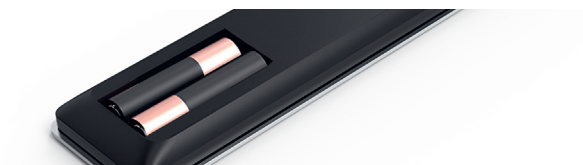

2. Alinhe a primeira pilha com o terminal positivo no telecomando, conforme ilustrado na imagem.

 Assegure-se de que os terminais (+ e -) estão alinhados corretamente.

 Verifique se as pilhas ficam bem instaladas.

3. Instale a tampa fazendo-a deslizar novamente para fechar o compartimento das pilhas.

Ensaie o funcionamento do telecomando. Se não estiver a funcionar, repita os passos acima.





 A instalação das pilhas é idêntica em ambos os telecomandos.

 Utilize apenas pilhas AAA LR03 (alcalinas de manganês) à prova de fugas. São necessárias duas pilhas por telecomando.







## Emparelhar com o telecomando Loewe stellar mini.

Quando liga  no televisor pela primeira vez, este liga-se automaticamente ao telecomando Loewe stellar mini. Para emparelhar manualmente o comando com o televisor, aponte-o para a parte frontal do televisor e prima ao mesmo tempo as teclas  e  durante três segundos.





 Não é necessário emparelhar o telecomando Loewe stellar.

 Mantenha as pilhas fora do alcance de crianças. Não deixe as pilhas expostas à luz solar nem as exponha ao fogo.

 Elimine as pilhas usadas num ecoponto. Para obter mais informações, consulte os avisos legais/ambientais.

## Programar os botões de dispositivo.

Para além da funcionalidade direta, a tecla da TV  e as teclas de dispositivo  e  também permitem o comando de outros dispositivos Loewe. Esta funcionalidade possibilita o comando direto de outros dispositivos de áudio da Loewe, leitores de Blu-ray e altifalantes de outros fabricantes. Os pontos debaixo de cada tecla indicam a respetiva função.

 TV em direto (premir 1 s),  
Modo: Loewe TV (premir 3 s)

 Entrada (premir 1 s),  
Modo: Loewe klang mr 1/3/5 (premir 3 s)

 Gravação (premir 3 s),  
Modo: Loewe klang bar 3/5 mr (premir 3 s)

## Programar outros dispositivos

Estas teclas também podem ser atribuídas para outros dispositivos. Por exemplo, se tiver um leitor Blu-ray ou um sintonizador por cabo associado a um dos botões de dispositivo, pode controlar o volume ou silenciar o som através do telecomando. Esta funcionalidade

torna o controlo do seu sistema de entretenimento ainda mais fácil. Pode encontrar mais informação sobre como programar o telecomando Loewe stellar no site da Loewe.

## Ativar o anel LED ajustar o brilho.

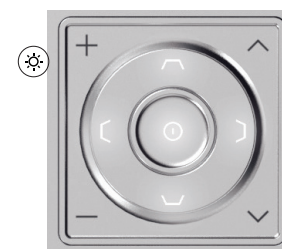

Prima continuamente a tecla  e, em simultâneo, uma das teclas numéricas 1, 2, 3, 4 ou 5 durante 3 segundos para mudar o brilho dos LED das teclas de seta.



O valor da tecla "1" corresponde à definição de brilho mais baixo, enquanto que o "5" ao valor mais alto. Mude a iluminação das teclas segundo a sua preferência.

Fácil e rápido.

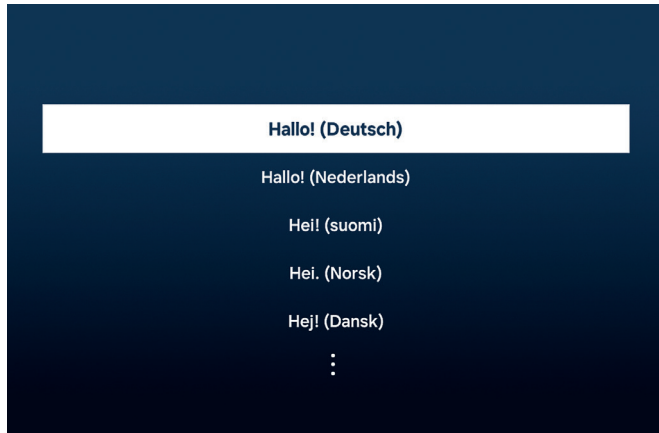
## Primeiros passos - Configuração inicial.



Selecionar o seu idioma para os menus.

Comece por escolher o idioma para os menus. Mude o idioma com as teclas de seta . Confirme com a tecla .



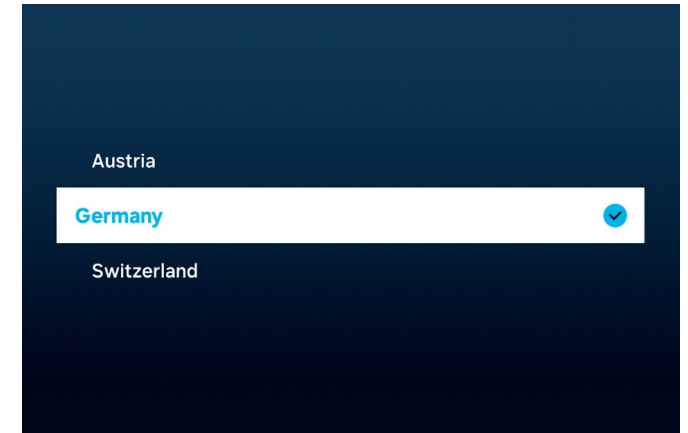

Começar a configuração inicial.

O equipamento Loewe stellar dispõe de um guia para a configuração inicial. Siga as instruções indicadas.



Selecionar o seu país.

Depois, escolha o seu país ou região através das teclas de setas . Confirme com a tecla .



Tenha atenção às instruções de segurança e às especificações técnicas deste televisor.



O aspeto da interface do utilizador pode mudar depois de uma atualização de software.

Centro de Apoio ao Cliente da Loewe  
[www.loewe.tv](http://www.loewe.tv)



Os serviços disponíveis podem variar de acordo com a região escolhida.

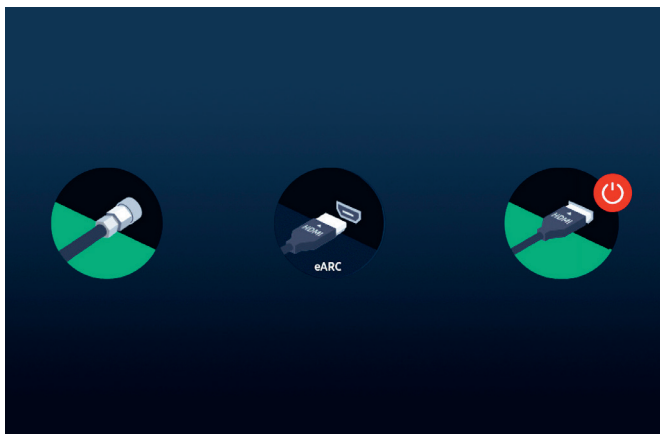

## Reconhecimento automático de ligação.

O equipamento Loewe stellar reconhece automaticamente antenas e dispositivos ligados por USB ou HDMI.

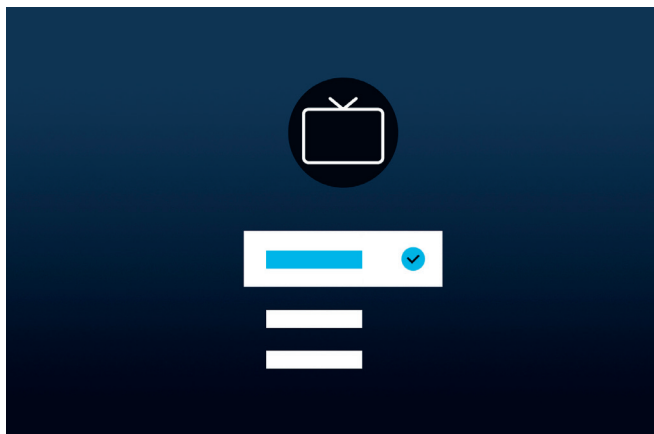

## Receção de TV e tipo de programas.

Depois do sinal terrestre ou por cabo ter sido reconhecido, escolha a receção de TV e o tipo de programas. No passo seguinte, todos os canais disponíveis serão gravados.

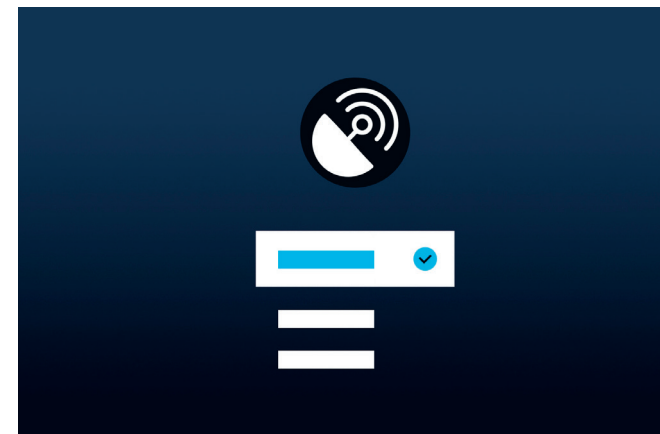

## Sinal por satélite.

Se estiver disponível um sinal por satélite, pode ajustar a sintonia neste menu.

Ajuste as opções de tipo de programas, escolha dos satélites, LNB, alcance de satélite e de pesquisa. Ao utilizar SAT MAIN e SAT SUB, pode escolher entre duplo ou principal neste menu.



Verifique se todos os dispositivos relevantes estão ligados.

Já está quase...

## Primeiros passos - Configuração inicial.

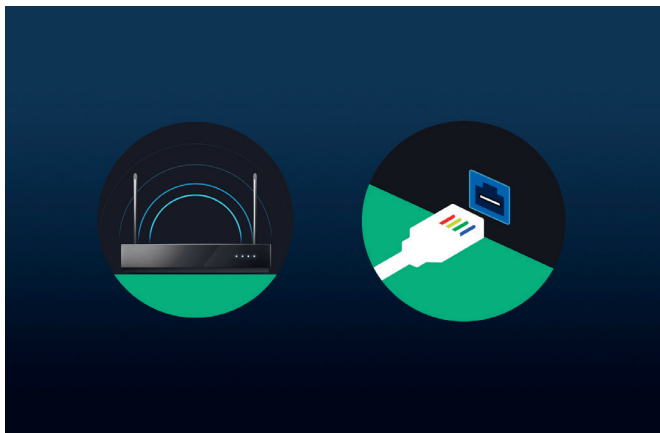

### Selecionar uma rede.



Para poder usufruir da sua smart TV no seu potencial máximo, é necessária uma ligação à Internet. Pode ligar o seu televisor Loewe a uma rede através de WLAN (sem fios) ou LAN (por cabo).

**WLAN** Consulte o passo seguinte. Tenha os dados de autenticação da WLAN à mão.

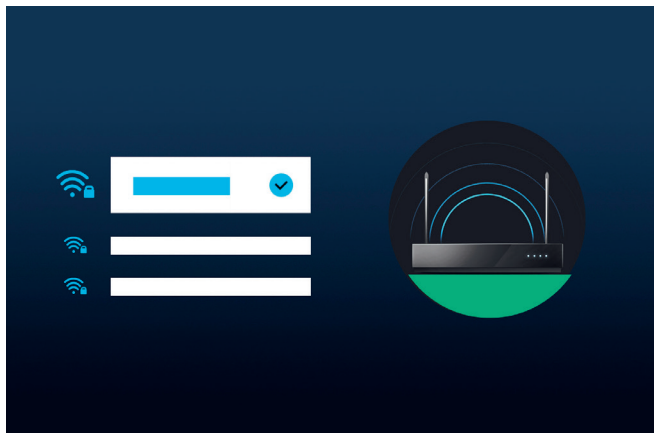
**LAN** Assegure-se de que o seu cabo de rede está ligado ao televisor e ao router.



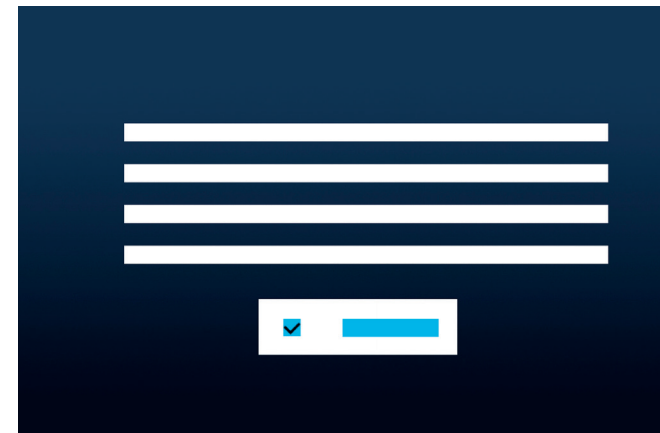

### Ligação por WLAN.

Quando utilizar a ligação por WLAN, ser-lhe-á pedido que introduza a sua palavra-passe. Utilize as teclas de setas , para navegar pelos números e letras, e a tecla  para os selecionar. Confirme com a tecla .



### Termos e condições e política de privacidade.

Para usufruir de todas as funcionalidades do seu equipamento, deve aceitar os termos e condições do Smart Hub, bem como a política de privacidade. Para este efeito, prima o botão de seleção  e clique em "Concordo com todos".

 Se não aceitar os termos e condições e a política de privacidade, alguns serviços poderão não estar disponíveis.

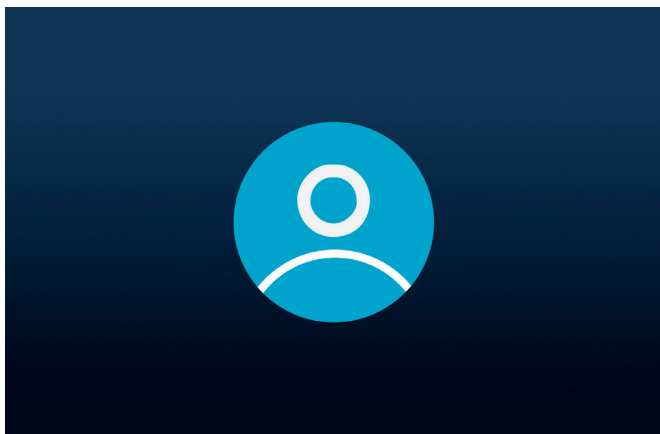

## Criar uma conta de utilizador.

Passo opcional: Prima a tecla de setas  para ignorar este passo. Inicie sessão numa conta Samsung já existente ou crie uma conta nova. Ao utilizar uma conta Samsung, poderá usufruir das melhores funcionalidades para a sua smart TV e mantê-la sempre atualizada.

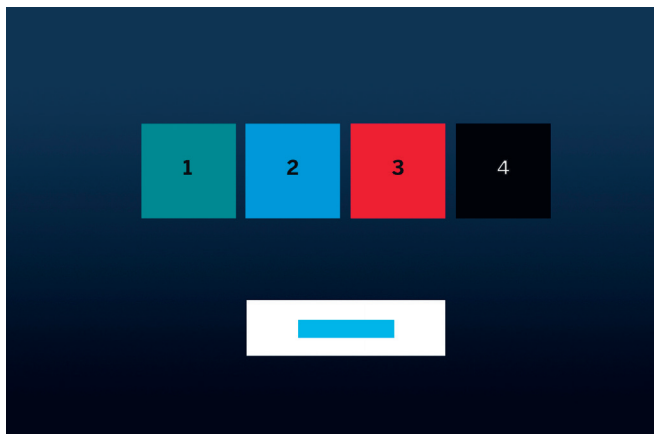

## Personalizar a barra de tarefas.

Neste passo, pode gravar e ordenar as apps na barra de tarefas. Algumas apps são pré-instaladas. As apps também podem ser personalizadas mais tarde no Smart Hub.

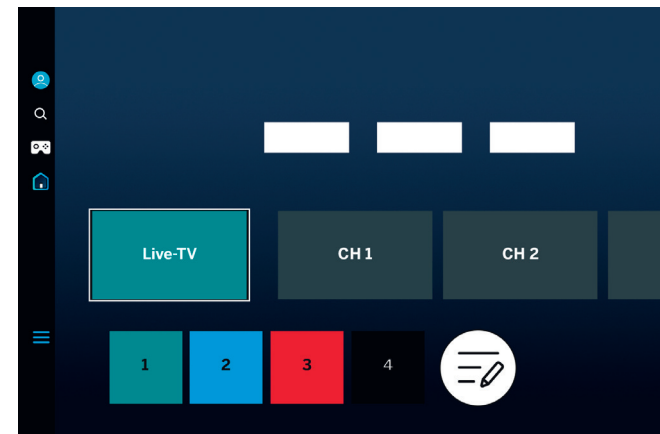

## Página inicial.

Quando aparece a página inicial, a configuração inicial está concluída. Chegou o momento de desfrutar da melhor experiência televisiva. Abra a televisão ao vivo ou a sua app favorita. Esperamos que desfrute do seu novo televisor Loewe.

 É necessária uma conta de utilizador para usufruir de apps ou de serviços de videoclube.



Smart Hub.

## Página inicial.

O Smart Hub é a página inicial do seu televisor. A partir daqui pode abrir apps, serviços ou deambular pela televisão ao vivo.

 Prima a tecla da página inicial no seu comando para regressar rapidamente a esta página.

Estão disponíveis as seguintes opções:

 Perfil de utilizador: Acesso ao perfil de utilizador.

 Pesquisa: pesquise canais, filmes ou apps. Comando por voz com o telecomando Loewestellar mini.

 Gaming Hub: Transmissão direta de jogos.

 Página inicial: Reorganize as apps.

 Dispositivos ligados  / Definições 

 Altere as definições de privacidade.

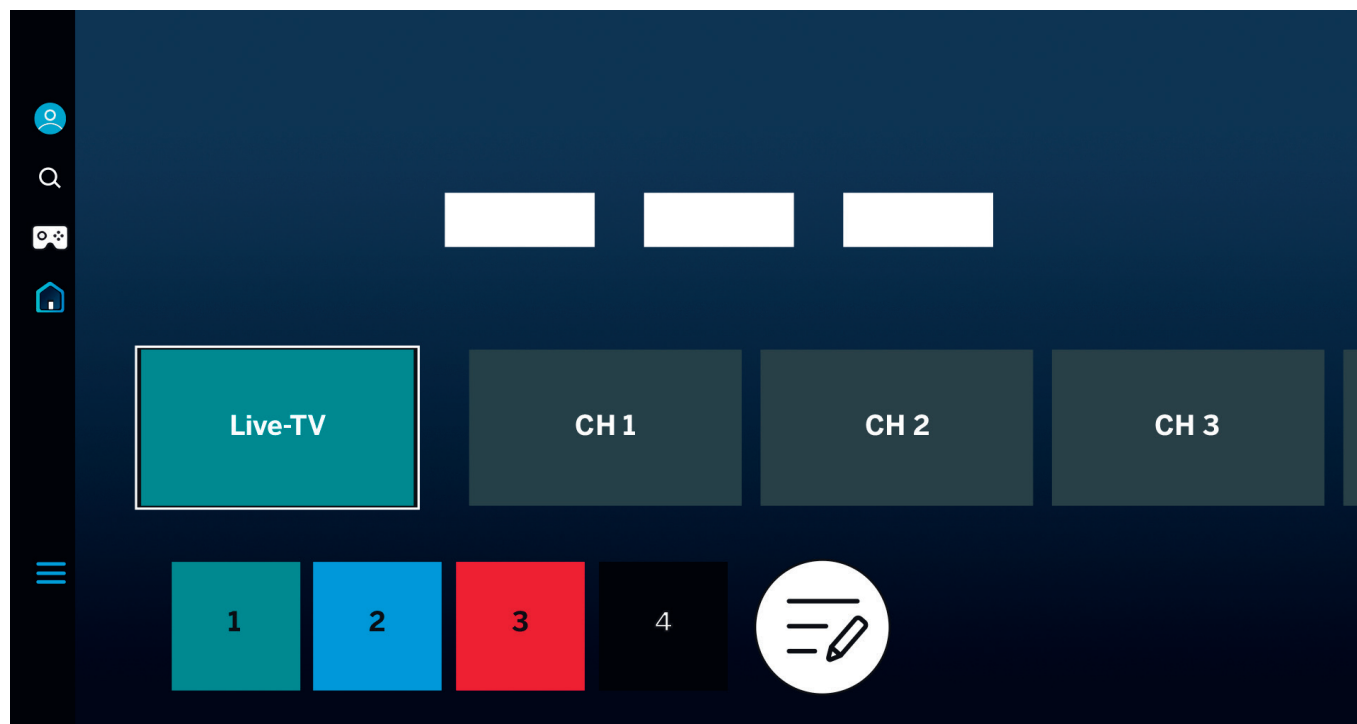

Utilize as setas  para navegar. O ícone realçado e aumentado é aquele que é selecionado.

Abra apps, serviços ou TV ao vivo premindo a tecla de seleção . À esquerda, estão disponíveis mais definições: Perfil de utilizador, pesquisa, modo ambiente, centro de jogos, multimédia e política de privacidade.

 Consoante o seu país ou a região, o visor e a informação podem variar.

Num relance.

## Guia de programação.

O guia de programação fornece informação sobre os programas televisivos atuais e futuros. Também pode utilizá-lo para programar as gravações.

 Prima a tecla do guia no telecomando para abrir o guia de programação.

Estão disponíveis as seguintes opções:

 Editar filtros de canais.

 Mostrar apenas canais televisivos.

 Mostrar apenas estações de rádio.

 Editar canais.

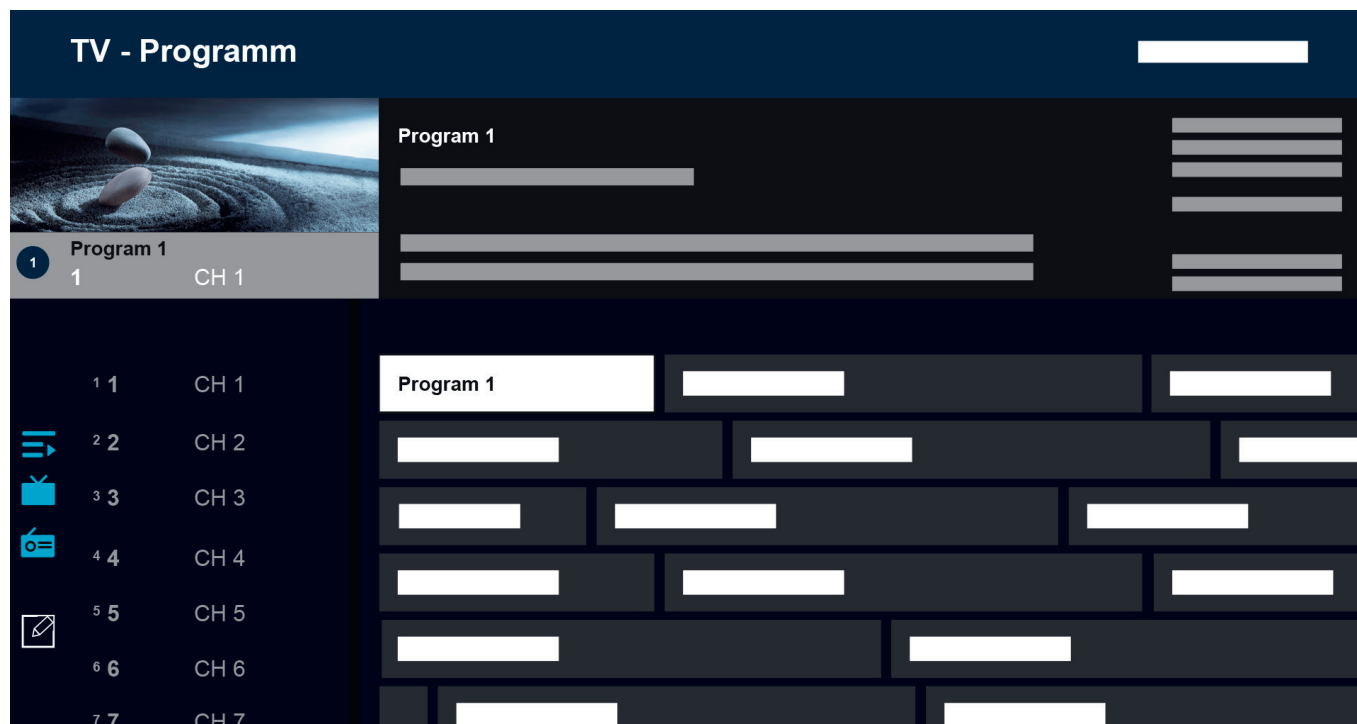

Funcionalidades adicionais no guia de programação:

- Pré-visualização de imagem ao vivo.
- Informação sobre o programa atual.
- Data e hora de visualização.
- Pré-visualização de todos os canais disponíveis.
- Vista geral do telecomando Loewe stellar mini.

Está disponível mais informação no manual eletrónico do Tizen OS.



 Consoante o seu país ou a região, o visor e a informação podem variar.

Gravar com a função dr+.

## Gravações múltiplas.

Gravar programas com a Loewe stellar, programar uma gravação ou utilizar o Timeshift para ver mais tarde um programa de TV em direto. As gravações são guardadas automaticamente na unidade de memória incorporada. Se pretender, também pode utilizar um dispositivo de armazenamento externo USB.

### Gravação instantânea.

Escolha o programa de TV em direto que pretende gravar e prima a tecla de gravação  ou . Selecione "Gravar " no menu seguinte para começar.

### Programar gravação.



Abra o guia de programas e escolha o programa que pretende gravar. Confirme premindo em  e selecione "Programar gravação" no menu seguinte para começar. Pode programar gravações manuais no gestor de programas.



### Gravações e gestor de programas.



A função de gravações e gestor de programas oferece uma vista geral das gravações anteriores e programadas.

### Gravações.

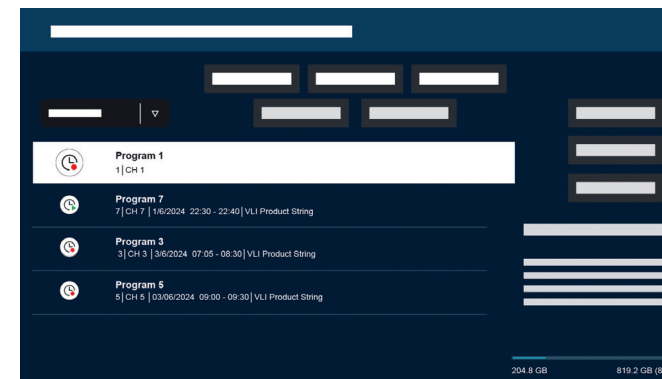
No modo de TV em direto, abra a lista de gravações disponíveis premindo  e, depois, selecione . Escolha a gravação pretendida com as setas e confirme com  para reproduzir a gravação.



### Programar.

No modo de TV em direto, prima  e selecione  para abrir uma vista geral de todas as gravações programadas. Pode agendar gravações manuais, bem como sequenciais, através do botão "Adicionar gravação".

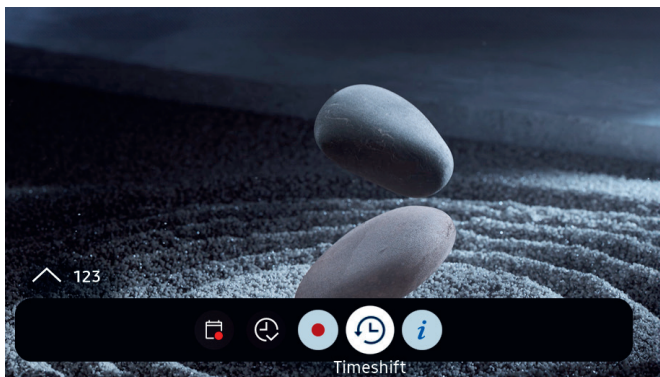

## Timeshift.

Prima  para ativar a função Timeshift.

Com a função Timeshift ativa, pode colocar um programa em pausa e continuar a vê-lo mais tarde ou até voltar a ver partes do programa.





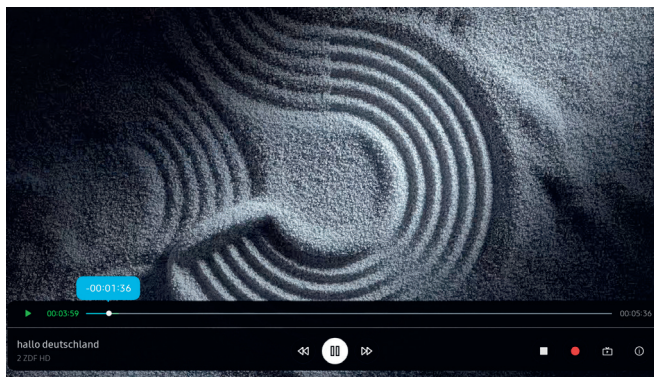

 Capacidade máxima de gravação: 90 minutos.

Para ver a barra de progresso no menu Timeshift, prima a seta para baixo .

Utilize as setas para navegar no menu Timeshift.



## Menu Timeshift:

-  Reproduzir/pausa em Timeshift.
-  Avançar rápido.
-  Rebobinar.
-  Parar Timeshift.
-  Iniciar gravação.
-  Voltar à TV em direto. O Timeshift permanece ativo.
-  Informação.

Leia todas as instruções de segurança antes de utilizar a função Timeshift, em especial a secção "Unidades de memória ligadas por USB". Desligar o dispositivo da fonte de alimentação elétrica pode causar perda de dados.

Está disponível informação adicional no manual eletrónico, na secção "Antes de utilizar as gravações e o Timeshift".

Uma receção brilhante.

## Loewe magic.light

Todas unidades Loewe stellar estão dotadas com a “luz mágica” da Loewe. Utilize a banda LED elegantemente dissimulada para produzir uma iluminação subtil de boas-vindas ou despedida, bem como para realçar o seu filme favorito com uma tonalidade quente de branco.

Personalize a magic.light conforme o seus desejos e pretensões. Saiba mais sobre esta funcionalidade nesta secção.

 Ativar definições:  
Prima a tecla magic.light e confirme com .

 Ligar ou desligar a banda de luz.

 Ajustar o brilho com as setas.

 Ajustar a saturação com as teclas de canal.



 Ajustar a cor com as setas.





Branco quente: 100% de saturação  
Branco frio: 0% de saturação

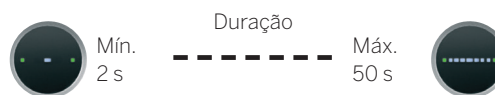

### Ajustar a duração da iluminação.

1. Mantenha premidas as teclas magic.light  e de definições  em simultâneo durante cinco segundos. O anel de insígnia Loewe irá exibir uma linha com sete pontos brancos. O número de pontos indica a duração da iluminação:



2. Agora, pode ajustar a duração. A linha dentro do anel de insígnia muda quando prime  para a esquerda ou direita.
3. Prima  para gravar a definição.

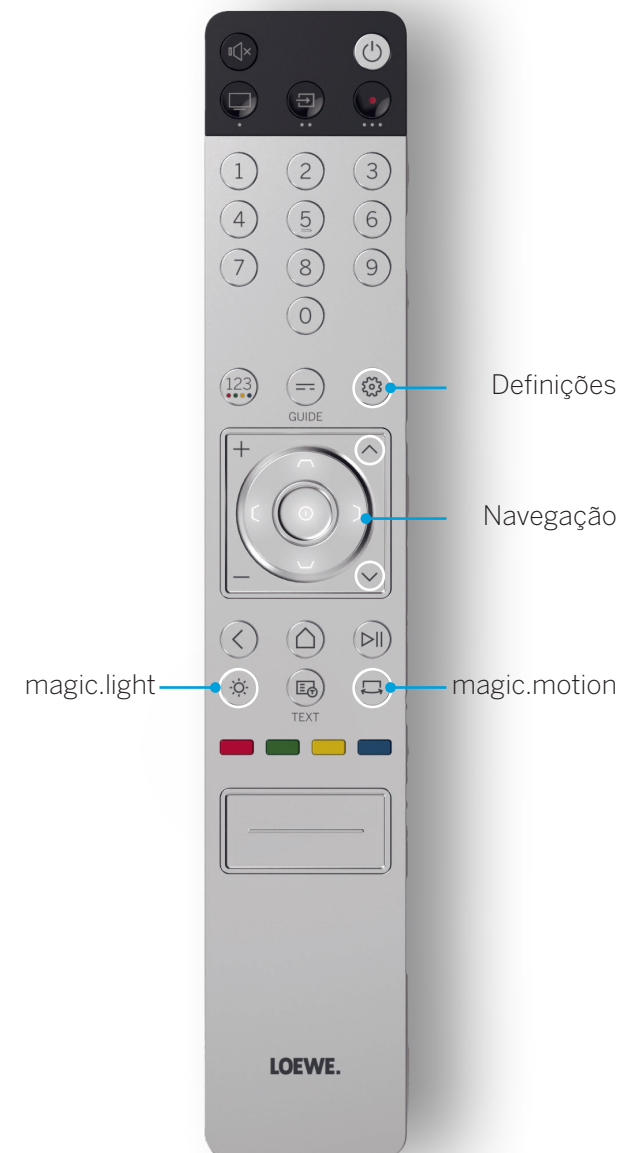



O ângulo perfeito.

## Loewe magic.motion

Com a funcionalidade magic.motion, poderá rodar o seu equipamento Loewe com um toque de um botão, graças ao suporte de chão motorizado stellar.

A tecla magic.motion  no seu telecomando Loewe stellar permite-lhe utilizar esta função.

---



 Prima a magic.motion.

---







 Prima as setas para rodar o televisor. Ângulo máx. de rotação: 45°

---

### Rodar o televisor

Prima em simultâneo as teclas magic.motion  e de definições  durante cinco segundos. É emitido um som breve. O modo de rotação está agora ativo.

Ao premir as setas , pode rodar o televisor num dos sentidos.

1. Mantenha premida a seta  para rodar o seu televisor completamente para a esquerda. Prima  para guardar esta posição. São emitidos dois sons breves.
2. Mantenha premida a seta  para rodar o seu televisor completamente para a direita. Prima  para guardar esta posição. São emitidos três sons breves.
3. Agora, volte a manter premida a seta esquerda para rodar o televisor para a posição desejada quando é desligado. Prima  para gravar esta posição. São emitidos quatro sons breves.
4. Por fim, prima novamente , para confirmar a posição gravada quando liga e desliga o televisor.
5. É emitido um som prolongado. O modo de rotação é concluído.



Reconhecimento de obstáculos: a função magic.motion irá parar automaticamente quando ocorrer colisão com um obstáculo.

Se decorrerem 20 segundos sem que haja qualquer comando, o modo de rotação é cancelado.

Informação útil.

## Apps e informação técnica.

### Descarregue a app my Loewe.

Utilize o seu smartphone para ler o código QR abaixo fazer o download desta app. A aplicação my Loewe é um ponto de entrada no mundo da Loewe e dá-lhe acesso a todos os manuais do utilizador dos seus produtos Loewe.



### Informação técnica.

Adquiriu um televisor com ecrã OLED que cumpre com os padrões de qualidade mais altos e cujo ecrã foi ensaiado para detetar falhas de píxeis. Não obstante o fabrico do ecrã ser sujeito às regras mais estritas, não é tecnicamente possível garantir a 100% que o equipamento estará isento de falhas de pixelização. Desde que este efeito esteja dentro dos limites especificados pela norma relevante (ISO 9241-307, classe de defeito II), não é considerada como defeito do equipamento nos termos da garantia. A tecnologia de díodos orgânicos emissores de luz (OLED) funciona com base em píxeis autoluminescentes e oferece vantagens substanciais em termos de qualidade de imagem e prestações. Sob determinadas circunstâncias, a exposição persistente num dos lados do material OLED pode causar aberrações de imagem permanentes e irreversíveis. Este tipo de anomalia de imagem residual ocorre quando o televisor exhibe conteúdos de imagem estática, nomeadamente, imagens estáticas, legendas, visores de títulos, apresentações ou sequências de vídeos num ciclo repetitivo, ou visualização estática num monitor de apresentação ou videojogos. Barras pretas em alguns formatos de ecrã também

podem originar anomalias cromáticas residuais. É importante salientar que estas anomalias de imagens residuais não constituem defeitos nos termos da garantia. Se as imagens estáticas forem apresentadas durante muito tempo, o televisor reduz automaticamente o contraste ou comuta para o modo de proteção de ecrã. Na próxima utilização do equipamento, este irá retomar imediatamente o estado de funcionamento normal. Sob condições normais de visualização, estas anomalias de imagem residual não ocorrem. Para manter a melhor qualidade de imagem a longo prazo, o seu televisor OLED Loewe calibra-se automaticamente em intervalos regulares.

### Unidades de memória ligadas por USB.

Desligar o televisor da tomada elétrica durante o funcionamento ou um corte de alimentação inadvertido (por exemplo, uma falha elétrica) pode danificar o sistema de ficheiros das unidades de memória e, conseqüentemente, a perda das transmissões gravadas. Nunca desligue a unidade de memória USB do televisor. Recomendamos que coloque o televisor no modo de espera antes de o desligar. A Loewe não assume qualquer responsabilidade pela perda dos dados guardados na unidade de memória incorporada no televisor.

### Atualização do software.

Pode descarregar as versões mais recentes de software no site da Loewe (indicado abaixo) e instalar as mesmas no seu televisor através de uma pen USB. Se o seu televisor estiver ligado à Internet, pode atualizá-lo diretamente através da liga-

ção à Internet. Pode encontrar mais informação sobre a atualização de software no manual do utilizador, disponível para download no site da Loewe. Não é possível garantir que todos os modelos da Loewe irão funcionar permanentemente, desde o seu lançamento, com todos os periféricos passíveis de serem ligados.

### Renúncia de responsabilidade sobre serviços digitais.

Os nossos televisores são “produtos com elementos digitais”, cujas funções básicas, como receção de TV por cabo ou satélite ou reprodução de DVD/Blu-ray através de um leitor ligado ao televisor, podem também, por princípio, serem utilizadas sem estes elementos digitais. Os elementos digitais disponíveis no televisor incluem, nomeadamente, apps, jogos, música, serviços de vídeo e outros programas, assim como plataformas que permitem descarregar e/ou aceder a apps adicionais. Os serviços, os conteúdos e/ou os elementos mencionados acima, assim como as plataformas por servidor necessárias para o seu acesso em plano de fundo através da Internet, são oferecidos e/ou fornecidos por terceiros. De notar que estes serviços externos exigem a aceitação dos termos e condições de utilização. Esta aceitação estabelece uma relação contratual direta entre o utilizador e os respetivos prestadores de serviços externos, independentemente da utilização de elementos digitais, serviços ou conteúdos. Na qualidade de fabricante do televisor, a Loewe Technology GmbH não tem qualquer influência no fornecimento de elementos digitais, serviços e conteúdos, sobre a sua qualidade, apresentação visual, atualizações disponibilizadas e, em especial, no fim de

## Declaração.

vida destes elementos digitais, serviços e conteúdos. Por outro, durante a vida útil do televisor, podem ser oferecidos novos elementos digitais, serviços ou conteúdos sem o seu consentimento expresso. Estes elementos digitais, serviços ou conteúdos adicionais resultam de, entre outros, inovação tecnológica e requisitos gerais de mercado. No entanto, o fornecimento de novos elementos digitais, serviços ou conteúdos não constitui uma obrigação. Em particular, não existe obrigação de fornecer substitutos ou sucessores após o fim de vida útil de um elemento digital, serviço ou conteúdo. Consulte os termos e condições de utilização em vigor para o seu equipamento.



A Loewe Technology GmbH confirma que os seus produtos cumprem os requisitos essenciais da diretiva 2014/53/UE, assim como as restantes diretivas UE pertinentes.

Dentro da gama de frequências de 5150 a 5350 MHz, este televisor só pode ser utilizado em espaços interiores, nos seguintes países:

Alemanha, Áustria, Bélgica, Bulgária, Croácia, Chipre, Dinamarca, Eslováquia, Eslovénia, Espanha, Estónia, Finlândia, França, Grécia, Hungria, Irlanda, Itália, Letónia, Lituânia, Luxemburgo, Malta, Países Baixos, Polónia, Portugal, Reino Unido, República Checa, Roménia, Suécia.

Pode encontrar a declaração de conformidade completa na seleção de produtos em:

**[www.loewe.tv/eu/en/service/support](http://www.loewe.tv/eu/en/service/support)**

## Edição.

Loewe Technology GmbH  
Industriestraße 11  
96317 Kronach, Alemanha  
[www.loewe.tv](http://www.loewe.tv)

Arquivo de registo: Frankfurt am Main, HRB 117013  
Representado por: Aslan Khabliev

A informação constante no presente documento pode ser alterada sem aviso prévio. Todos os direitos reservados, incluindo tradução, alterações técnicas e erros.









**LOEWE.**

## Loewe Technology GmbH

Customer Care Center  
Industriestraße 11  
96317 Kronach, Deutschland  
Tel +49 9261 99-500  
E-mail: ccc@loewe.de  
Printed in Germany  
Edition 1, 04.24  
MCM/SB/PH/MJ/LC

Änderungen vorbehalten  
Subject to modifications  
Wijzigingen voorbehouden  
Modifications réservée  
Con riserva di modifiche  
Reservado el derecho a modificaciones  
Alterações reservadas

loewe.tv     



37360000