



4-Series® Control Systems

Product Manual

Crestron Electronics, Inc.

Original Instructions

The U.S. English version of this document is the original instructions.
All other languages are a translation of the original instructions.

Crestron product development software is licensed to Crestron dealers and Crestron Service Providers (CSPs) under a limited nonexclusive, nontransferable Software Development Tools License Agreement. Crestron product operating system software is licensed to Crestron dealers, CSPs, and end-users under a separate End-User License Agreement. Both of these Agreements can be found on the Crestron website at www.crestron.com/legal/software_license_agreement.

The product warranty can be found at www.crestron.com/warranty.

The specific patents that cover Crestron products are listed at www.crestron.com/legal/patents.

Certain Crestron products contain open source software. For specific information, visit www.crestron.com/opensource.

Crestron, the Crestron logo, .AV Framework, 3-Series, 4-Series, Cresnet, Crestron Fusion, Crestron Home, Crestron Pyng, Crestron Toolbox, infiNET EX, the infiNET EX logo, SIMPL+, VT-Pro e, and XiO Cloud are either trademarks or registered trademarks of Crestron Electronics, Inc. in the United States and/or other countries. Apple, HomeKit, iPad, and iPhone are either trademarks or registered trademarks of Apple, Inc. in the United States and/or other countries. Android is either a trademark or a registered trademark of Google Inc. in the United States and/or other countries. Linux is either a trademark or a registered trademark of Linus Torvalds in the United States and/or other countries. Active Directory, Azure, and Microsoft are either trademarks or registered trademarks of Microsoft Corporation in the United States and/or other countries. Python is either a trademark or a registered trademark of Python Software Foundation in the United States and/or other countries. UL is either a trademark or a registered trademark of Underwriters Laboratories, Inc. in the United States and/or other countries. Wi-Fi is either a trademark or a registered trademark of Wi-Fi Alliance in the United States and/or other countries. Other trademarks, registered trademarks, and trade names may be used in this document to refer to either the entities claiming the marks and names or their products. Crestron disclaims any proprietary interest in the marks and names of others. Crestron is not responsible for errors in typography or photography.

infiNET EX 

©2024 Crestron Electronics, Inc.

Contents

- Overview 1**
- Features 2
- AV4 Features 3
- CP4 Features 7
- CP4N Features 10
- CP4-R Features 14
- DIN-AP4 Features 16
- DIN-AP4-R Features 20
- MC4 Features 22
- MC4-I Features 27
- MC4-R Features 32
- MC4-R-I Features 35
- PRO4 Features 38
- RMC4 Features 42
- Specifications 46**
- AV4 Specifications 47
- Product Specifications 47
- Dimension Drawings 51
- CP4 Specifications 53
- Product Specifications 53
- Dimension Drawings 56
- CP4N Specifications 57
- Product Specifications 57
- Dimension Drawings 60
- CP4-R Specifications 62
- Product Specifications 62
- Dimension Drawings 65
- DIN-AP4 Specifications 66
- Product Specifications 66
- Dimension Drawings 69
- DIN-AP4-R Specifications 70
- Product Specifications 70
- Dimension Drawings 73
- MC4 Specifications 74
- Product Specifications 74
- Dimension Drawings 77
- MC4-I Specifications 79
- Product Specifications 79
- Dimension Drawings 82

MC4-R Specifications	84
Product Specifications	84
Dimension Drawings	87
MC4-R-I Specifications	88
Product Specifications	88
Dimension Drawings	91
PRO4 Specifications	92
Product Specifications	92
Dimension Drawings	96
RMC4 Specifications	98
Product Specifications	98
Dimension Drawings	101
Installation	103
AV4 Installation	104
In the Box	104
Install the Control System	104
Connect the Control System	105
Connect the Control Subnet	106
CP4 Installation	107
In the Box	107
Install the Control System	107
Connect the Control System	108
CP4N Installation	110
In the Box	110
Install the Control System	110
Connect the Control System	111
Connect the Control Subnet	113
CP4-R Installation	114
In the Box	114
Install the Control System	114
Connect the Control System	115
Install IR Emitters (Optional)	116
DIN-AP4 Installation	119
In the Box	119
Mount the Control System	119
Connect the Control System	120
DIN-AP4-R Installation	124
In the Box	124
Mount the Control System	124
Connect the Control System	125
MC4 Installation	129
In the Box	129
Install the Control System	129

Connect the Control System	130
Mount the Antenna	131
MC4-I Installation	132
In the Box	132
Install the Control System	132
Connect the Control System	133
Mount the Antenna	134
MC4-R Installation	135
In the Box	135
Install the Control System	135
Connect the Control System	136
Mount the Antenna	137
Install IR Emitters (Optional)	138
MC4-R-I Installation	140
In the Box	140
Install the Control System	140
Connect the Control System	141
Mount the Antenna	142
Install IR Emitters (Optional)	143
PRO4 Installation	145
In the Box	145
Install the Control System	145
Connect the Control System	146
Connect the Control Subnet	147
RMC4 Installation	148
In the Box	148
Mount the Control System	148
Connect the Control System	150
Configuration	153
Initial Setup	154
Access the Web Configuration Interface	154
Create an Admin Account	155
Set the Time Zone	156
Assign the RF Channel (MC4/MC4-I Only)	157
Acquire Wireless Devices (MC4/MC4-I Only)	157
Pair with Apple HomeKit	158
Configure .AV Framework Software	158
Web Configuration	160
Actions Menu	161
Status	163
Settings	168
Security	187
802.1x Configuration	196

Programming	199
Reference Topics	200
Tools and Utilities	201
4-Series Architecture	202
Memory and Directory Structure	202
Console Commands	204
Establish Communications	205
USB Connection	205
TCP/IP Connection	207
Set a Logon Banner	208
Time and Date Settings	209
Authentication	210
Create an Admin Account	210
Account Recovery	210
User and Group Management	211
User Group Rights	214
Password Management	215
Login Behavior	216
Session Timeout Functions	218
Locked User Functions	219
Blocked IP Address Functions	219
Certificate Management	221
Certificate Requirements	221
Add a Certificate	222
List and View Certificates	223
Remove a Certificate	224
TLS	224
Server Certificates	225
802.1X	230
Firmware Updates	232
Message Logging	233
Persistent Log	233
Remote System Logging	235
Audit Logging	236
Control Subnet	238
Control Subnet Architecture	239
Control Subnet Configuration	240
Program Management	242
Load Programs to the Control System	242
IP Table Configuration	242
Run Multiple Programs	245
Run Programs from External Storage	246
Primary-Secondary Mode	247

Definitions	247
Primary-Secondary Configuration	248
Functional Behavior	249
Auto Update Mechanism	251
Configure the Auto Update Mechanism	251
Manifest File	252
Results File	260
Error Handling	262
Restore to Factory Defaults	263
Port Forwarding	264
Pairing a 4-Series Control System with Apple HomeKit Technology	265
Prerequisites	266
Pair with Apple HomeKit	267
Setting Up Apple HomeKit with Crestron	274
Joins and Parameters for Apple HomeKit Module	276
Secure Device Deployment	277
Resources	278
Crestron Support and Training	278
Programmer and Developer Resources	278
Product Certificates	278
Related Documentation	278

Overview

Crestron 4-Series® Control Systems unify building technologies so they can communicate and work together efficiently. Their unique distributed architecture enables multitasking that is essential to a complete building control solution. Up to 10 programs can communicate together while operating independently and simultaneously. Code is organized into a few smaller programs rather than one large one, which simplifies programming, troubleshooting, and uploading programs.

4-Series® Control Systems offer the following features:

- Scalable hardware that supports a broad range of space types and architectures
- One system running multiple programs
- SNMP and BACnet/IP support to seamlessly communicate and integrate with IT, HVAC, BMS, and security systems
- XiO Cloud® service support
- Full network security protocols, including 802.1X, SSH, TLS, and Active Directory® service

For more information on Crestron 4-Series® Control Systems, refer to www.crestron.com/Products/Featured-Solutions/4-Series.

NOTE: 4-Series Control Systems are functionally similar. For simplicity within this documentation, the term "control system" is used except where otherwise noted.

Crestron offers the following variations on standard control system models. Certain settings and features described in this document and not applicable to these models.

- The [CP4-R](#), [DIN-AP4-R](#), [MC4-R](#), and [MC4-R-I](#) control systems are designed to run the Crestron Home® operating system exclusively.
- The [Crestron Virtual Control \(VC-4\)](#) server-based control system resides entirely on a remote server, which is installed and configured using supported Linux® operating system platforms.

Features

This section provides the following information:

- [AV4 Features](#)
- [CP4 Features](#)
- [CP4N Features](#)
- [CP4-R Features](#)
- [DIN-AP4 Features](#)
- [DIN-AP4-R Features](#)
- [MC4 Features](#)
- [MC4-I Features](#)
- [MC4-R Features](#)
- [MC4-R-I Features](#)
- [PRO4 Features](#)
- [RMC4 Features](#)

NOTE: For PC4-R, VC4, and VC-4-PC-3 features, refer to [PC4-R Features](#), [VC-4 Features](#), and [VC-4-PC-3 Features](#)

AV4 Features

The AV4 is a secure, high-performance control processor with a powerful 4-Series™ control engine and an enhanced feature set, including available control card expansion slots (via the CAGE3 accessory) and dedicated Control Subnet ports. The AV4 is designed to integrate and automate technology within any modern networked home, commercial building, or government facility. Isolated Control Subnet ports provide a Gigabit Ethernet LAN dedicated to Crestron devices.



Key features include:

- 4-Series™ control system with 2 GB SDRAM and 8 GB flash memory
- Embedded 4-Series multicore CPU processor
- iPhone®, iPad®, and Android™ device control app support
- XPanel computer and web based control
- Modular programming architecture
- Onboard IR/Serial, COM, I/O, relay, Cresnet® network, and high-speed gigabit Ethernet control ports
- Control Subnet ports with PoE+ providing a dedicated local network for Crestron® devices
- High-speed USB 2.0 host port and rear panel memory card slot
- Three control card expansion slots (optional) available via the CAGE3 accessory
- IEC 61000-4-5 Installation Class 4 surge immunity on COM, Versiport, and network connections
- Support for Crestron Fusion® software and XiO Cloud® service
- Native .AV Framework™ software program
- Enterprise-class network security and authentication
- SNMP V3 remote IT management support
- Native BACnet network/IP support
- Installer setup via software, web browser, or cloud

- IPv6 ready
- Integrates with Apple® HomeKit® technology
- Rack mountable

4-Series Control Engine

4-Series control systems come equipped with an upgraded multicore CPU, delivering a sizable speed and performance increase compared to all Crestron 3-Series® control processors. The improved performance allows 4-Series control systems to handle the increasing demands of an advanced automated system. Crestron 4-Series delivers a dynamic and secure control system platform capable of managing a room full of disparate technologies.

Reliable networking and IP control afford seamless integration with other systems and devices, with add-on control capability using Crestron touch screens, wireless remotes, and mobile device apps, as well as remote management through Crestron Fusion® software and the XiO Cloud® service.

Modular Programming Architecture

The AV4 provides a modular programming architecture that allows the AV4 to run up to ten programs simultaneously. Programmers can develop and run independent, device-specific programs, enabling each program to be optimized for a specific function and allowing for changes to be made to one program without affecting the whole system.

Dedicated Control Subnet

The Crestron Control Subnet is a Gigabit Ethernet network dedicated to Crestron devices. Via the Control Subnet ports, an installer can connect up to four touch screens or wireless gateways or can add Crestron PoE switches ([CEN-SW-POE-5](#) or [CEN-SWPOE-16](#)) to handle multiple touch screens, gateways, AV components, and other devices. Each port also supports PoE+ using the optional [PW-5430DUS](#) power supply. Automatic configuration of the entire subnet is performed by the AV4, discovering each device and assigning IP addresses without any extra effort from the installer.¹

A separate LAN port provides a single-point connection to the local network, requiring only one IP address for the entire control system. The LAN port allows for interconnectivity between devices on the local subnet and other devices, systems, servers, and WAN/internet connections outside the local subnet. For sensitive applications that require heightened security, the entire Control Subnet can be isolated completely from the local network.

Onboard Control Ports

Through a full complement of onboard control ports, the AV4 can be integrated with audio, video, lighting, motorized shades, thermostats, door locks, sensors, security systems, and other equipment.¹

- Gigabit Ethernet provides an interface for connecting to the building network and controlling Crestron AV switchers, audio processors, power controllers, and other IP controllable equipment.

- Cresnet® network connectivity provides support for Crestron lighting dimmers, motorized shades, sensors, thermostats, keypads, and more.
- Onboard RS-232, IR/serial, relay, and Versiport I/O control ports enable direct integration with all types of third-party equipment.

Expanded connectivity can be provided to the AV4 via Crestron [control port expansion modules](#), [Ethernet to Cresnet bridges](#), [wired Ethernet I/O modules](#), [wireless network I/O modules](#), or [infiNET EX® network wireless gateways](#).

Crestron Fusion Room Monitoring and Scheduling

Crestron Fusion software provides an integrated platform for creating smart buildings that save energy and enhance worker productivity. As part of a complete managed network in a corporate enterprise, college campus, convention center, or any other facility, the AV4 works with Crestron Fusion to enable remote scheduling, monitoring, and control of rooms and technology from a central help desk or mobile app. It also enables organizations to reduce energy consumption by tracking real-time usage and automating control of AV, lighting, shades, and HVAC. For more information, visit www.crestron.com/fusion.

XiO Cloud Provisioning and Management

4-Series control systems leverage the power and flexibility of XiO Cloud services, enabling users to remotely provision, monitor, and manage Crestron devices across an enterprise network. XiO Cloud can be used to configure and load programs to the control system before it is received, making the control system fully functional as soon as it is connected to the network. XiO Cloud is built on the Microsoft® Azure® software platform and utilizes Microsoft's industry leading Azure IoT Hub technology. XiO Cloud enables installers and IT managers to deploy and manage thousands of devices in the time it previously took to manage just one. Unlike other virtual machine based cloud solutions, Azure services offer unlimited scalability to suit the ever growing needs of an enterprise. For more information, visit www.crestron.com/xiocloud.

.AV Framework Software

The AV4 provides native support for the .AV Framework™ software program. .AV Framework software is a web-based management solution that is used to deploy scalable Crestron® enterprise room solutions without requiring any programming. For more information on the capabilities supported by .AV Framework, visit www.crestron.com/avframework.

Enhanced Enterprise-Grade Security

The AV4 is an enterprise-class control processor that can be deployed across hundreds of spaces and set up easily using a web browser, [Crestron Toolbox™ software](#), or XiO Cloud. It employs standard network security protocols, including 802.1X network access control, Active Directory® service authentication, SSH, TLS, and HTTPS to ensure reliability and compliance with your organization's IT policies.

The AV4 is configured to meet Crestron's enhanced security standards right out of the box. The AV4 ships with authentication turned on and requires creating an administrator account before access is granted to device configuration and control interfaces.

SNMP V3 Support

Built-in SNMP V3 support permits integration with third-party IT management software, allowing network administrators to manage and control Crestron systems on the network in an IT-friendly format.

Control Card Expansion Slots

Additional control ports can be added to the AV4 using [control cards](#) and the [CAGE3](#) control card expansion cage. The CAGE3 accessory installs into the AV4, providing three control card expansion slots on the AV4 rear panel. Adding the CAGE3 option affords significant expansion capability without requiring any additional rack space.

BACnet Support

Native support for the BACnet™ communication protocol provides a direct interface to third-party building management systems over Ethernet, simplifying integration with HVAC, security, and other systems. Using BACnet, each system runs independently but communicates together on one platform.²

Apple HomeKit Integration

The AV4 supports integration with an Apple® HomeKit® technology system. Once the AV4 is paired with a HomeKit system via [SIMPL](#) programming, a Crestron [TSR-310](#) can be used to control supported Apple devices. A pairing QR code is affixed to the AV4 that makes it easy to pair the control system directly to the Apple Home app.³

Notes:

1. The following connections comply with IEC 61000-4-5 Installation Class 4 surge immunity levels: COM 1–6, I/O 1–8, NET, LAN, and CONTROL SUBNET.
2. A BACnet and IP license is required. A free license is available to support up to 50 BACnet objects on a single 4-Series control system. Support for more than 50 BACnet objects requires the purchase of one [SW-3SERIES-BACNET-50+](#) license. The AV4 supports a maximum of 2000 BACnet objects when dedicated for BACnet use only. Actual capabilities are contingent upon the overall program size and complexity. To obtain the license, visit www.crestron.com/bacnetlicense.
3. This feature is only available when using the TSR-310. Other Crestron touch screens, handheld remotes, and keypads are not supported. For these interfaces, traditional IR or CEC control must be used to control supported Apple devices.

CP4 Features

The CP4 is a secure, high-performance control processor with a powerful 4-Series™ control engine. The CP4 is designed to integrate and automate technology within any modern networked home, commercial building, or government facility.



Key features include:

- 4-Series™ control system with 2 GB SDRAM and 8 GB flash memory
- Embedded 4-Series multicore CPU processor
- iPhone®, iPad®, and Android™ device control app support
- XPanel computer and web based control
- Modular programming architecture
- Onboard IR/Serial, COM, I/O, relay, Cresnet® network, and high-speed gigabit Ethernet control ports
- High-speed USB 2.0 host port and rear panel memory card slot
- Support for Crestron Fusion® software and XiO Cloud® service
- Native .AV Framework™ software program
- Enterprise-class network security and authentication
- SNMP V3 remote IT management support
- Native BACnet network/IP support
- Installer setup via software, web browser, or cloud
- IPv6 ready
- Integrates with Apple® HomeKit® technology
- Rack mountable

4-Series Control Engine

4-Series control systems come equipped with an upgraded multicore CPU, delivering a sizable speed and performance increase compared to all Crestron 3-Series® control processors. The improved performance allows 4-Series control systems to handle the increasing demands of an advanced automated system. Crestron 4-Series delivers a dynamic and secure control system platform capable of managing a room full of disparate technologies.

Reliable networking and IP control afford seamless integration with other systems and devices, with add-on control capability using Crestron touch screens, wireless remotes, and mobile device apps, as well as remote management through Crestron Fusion® software and the XiO Cloud® service.

Modular Programming Architecture

The CP4 provides a modular programming architecture that allows the CP4 to run up to ten programs simultaneously. Programmers can develop and run independent, device-specific programs, enabling each program to be optimized for a specific function and allowing for changes to be made to one program without affecting the whole system.

Onboard Control Ports

Through a full complement of onboard control ports, the CP4 can be integrated with audio, video, lighting, motorized shades, thermostats, door locks, sensors, security systems, and other equipment.

- Gigabit Ethernet provides an interface for connecting to the building network and controlling Crestron AV switchers, audio processors, power controllers, and other IP controllable equipment.
- Cresnet® network connectivity provides support for Crestron lighting dimmers, motorized shades, sensors, thermostats, keypads, and more.
- Onboard RS-232, IR/serial, relay, and Versiport I/O control ports enable direct integration with all types of third-party equipment.

Expanded connectivity can be provided to the CP4 via Crestron [control port expansion modules](#), [Ethernet to Cresnet bridges](#), [wired Ethernet I/O modules](#), [wireless network I/O modules](#), or [infiNET EX® network wireless gateways](#).

Crestron Fusion Room Monitoring and Scheduling

Crestron Fusion software provides an integrated platform for creating smart buildings that save energy and enhance worker productivity. As part of a complete managed network in a corporate enterprise, college campus, convention center, or any other facility, the CP4 works with Crestron Fusion to enable remote scheduling, monitoring, and control of rooms and technology from a central help desk or mobile app. It also enables organizations to reduce energy consumption by tracking real-time usage and automating control of AV, lighting, shades, and HVAC. For more information, visit www.crestron.com/fusion.

XiO Cloud Provisioning and Management

4-Series control systems leverage the power and flexibility of XiO Cloud services, enabling users to remotely provision, monitor, and manage Crestron devices across an enterprise network. XiO Cloud can be used to configure and load programs to the control system before it is received, making the control system fully functional as soon as it is connected to the network. XiO Cloud is built on the Microsoft® Azure® software platform and utilizes Microsoft's industry leading Azure IoT Hub technology. XiO Cloud enables installers and IT managers to deploy and manage thousands of devices in the time it previously took to manage just one. Unlike other virtual machine based cloud solutions, Azure services offer unlimited scalability to suit the ever growing needs of an enterprise. For more information, visit www.crestron.com/xiocloud.

.AV Framework Software

The CP4 provides native support for the .AV Framework™ software program. .AV Framework software is a web-based management solution that is used to deploy scalable Crestron® enterprise room solutions without requiring any programming. For more information on the capabilities supported by .AV Framework, visit www.crestron.com/avframework.

Enhanced Enterprise-Grade Security

The CP4 is an enterprise-class control processor that can be deployed across hundreds of spaces and set up easily using a web browser, [Crestron Toolbox™ software](#), or XiO Cloud. It employs standard network security protocols, including 802.1X network access control, Active Directory® service authentication, SSH, TLS, and HTTPS to ensure reliability and compliance with your organization's IT policies.

The CP4 is configured to meet Crestron's enhanced security standards right out of the box. The CP4 ships with authentication turned on and requires creating an administrator account before access is granted to device configuration and control interfaces.

SNMP V3 Support

Built-in SNMP V3 support permits integration with third-party IT management software, allowing network administrators to manage and control Crestron systems on the network in an IT-friendly format.

BACnet Support

Native support for the BACnet™ communication protocol provides a direct interface to third-party building management systems over Ethernet, simplifying integration with HVAC, security, and other systems. Using BACnet, each system runs independently but communicates together on one platform.¹

Apple HomeKit Integration

The CP4 supports integration with an Apple® HomeKit® technology system. Once the CP4 is paired with a HomeKit system via [SIMPL](#) programming, a Crestron [TSR-310](#) can be used to control supported Apple devices. A pairing QR code is affixed to the CP4 that makes it easy to pair the control system directly to the Apple Home app.²

Notes:

1. A BACnet and IP license is required. A free license is available to support up to 50 BACnet objects on a single 4-Series control system. Support for more than 50 BACnet objects requires the purchase of one [SW-3SERIES-BACNET-50+](#) license. The CP4 supports a maximum of 1000 BACnet objects when dedicated for BACnet use only. Actual capabilities are contingent upon the overall program size and complexity. To obtain the license, visit www.crestron.com/bacnetlicense.
2. This feature is only available when using the TSR-310. Other Crestron touch screens, handheld remotes, and keypads are not supported. For these interfaces, traditional IR or CEC control must be used to control supported Apple devices.

CP4N Features

The CP4N is a secure, high-performance control processor with a powerful 4-Series™ control engine. The CP4N is designed to integrate and automate technology within any modern networked home, commercial building, or government facility. An isolated Control Subnet port provides a Gigabit Ethernet LAN dedicated to Crestron devices.



Key features include:

- 4-Series™ control system with 2 GB SDRAM and 8 GB flash memory
- Embedded 4-Series multicore CPU processor
- iPhone®, iPad®, and Android™ device control app support
- XPanel computer and web based control
- Modular programming architecture
- Onboard IR/Serial, COM, I/O, relay, Cresnet® network, and high-speed gigabit Ethernet control ports
- Control Subnet port providing a dedicated local network for Crestron® devices
- High-speed USB 2.0 host port and rear panel memory card slot
- Support for Crestron Fusion® software and XiO Cloud® service
- Native .AV Framework™ software program
- Enterprise-class network security and authentication
- SNMP V3 remote IT management support
- Native BACnet network/IP support
- Installer setup via software, web browser, or cloud
- IPv6 ready
- Integrates with Apple® HomeKit® technology
- Rack mountable

4-Series Control Engine

4-Series control systems come equipped with an upgraded multicore CPU, delivering a sizable speed and performance increase compared to all Crestron 3-Series® control processors. The improved performance allows 4-Series control systems to handle the increasing demands of an advanced automated system. Crestron 4-Series delivers a dynamic and secure control system platform capable of managing a room full of disparate technologies.

Reliable networking and IP control afford seamless integration with other systems and devices, with add-on control capability using Crestron touch screens, wireless remotes, and mobile device apps, as well as remote management through Crestron Fusion® software and the XiO Cloud® service.

Modular Programming Architecture

The CP4N provides a modular programming architecture that allows the CP4N to run up to ten programs simultaneously. Programmers can develop and run independent, device-specific programs, enabling each program to be optimized for a specific function and allowing for changes to be made to one program without affecting the whole system.

Dedicated Control Subnet

The Crestron Control Subnet is a Gigabit Ethernet network dedicated to Crestron devices. Via the Control Subnet ports, an installer can connect a single touch screen or wireless gateway or can add Crestron PoE switches ([CEN-SW-POE-5](#) or [CEN-SWPOE-16](#)) to handle multiple touch screens, gateways, AV components, and other devices. Automatic configuration of the entire subnet is performed by the CP4N, discovering each device and assigning IP addresses without any extra effort from the installer.¹

A separate LAN port provides a single-point connection to the local network, requiring only one IP address for the entire control system. The LAN port allows for interconnectivity between devices on the local subnet and other devices, systems, servers, and WAN/internet connections outside the local subnet. For sensitive applications that require heightened security, the entire Control Subnet can be isolated completely from the local network.

Onboard Control Ports

Through a full complement of onboard control ports, the CP4N can be integrated with audio, video, lighting, motorized shades, thermostats, door locks, sensors, security systems, and other equipment.

- Gigabit Ethernet provides an interface for connecting to the building network and controlling Crestron AV switchers, audio processors, power controllers, and other IP controllable equipment.
- Cresnet® network connectivity provides support for Crestron lighting dimmers, motorized shades, sensors, thermostats, keypads, and more.
- Onboard RS-232, IR/serial, relay, and Versiport I/O control ports enable direct integration with all types of third-party equipment.

Expanded connectivity can be provided to the CP4N via Crestron [control port expansion modules](#), [Ethernet to Cresnet bridges](#), [wired Ethernet I/O modules](#), [wireless network I/O modules](#), or [infiNET EX® network wireless gateways](#).

Crestron Fusion Room Monitoring and Scheduling

Crestron Fusion software provides an integrated platform for creating smart buildings that save energy and enhance worker productivity. As part of a complete managed network in a corporate enterprise, college campus, convention center, or any other facility, the CP4N works with Crestron Fusion to enable remote scheduling, monitoring, and control of rooms and technology from a central help desk or mobile app. It also enables organizations to reduce energy consumption by tracking real-time usage and automating control of AV, lighting, shades, and HVAC. For more information, visit www.crestron.com/fusion.

XiO Cloud Provisioning and Management

4-Series control systems leverage the power and flexibility of XiO Cloud services, enabling users to remotely provision, monitor, and manage Crestron devices across an enterprise network. XiO Cloud can be used to configure and load programs to the control system before it is received, making the control system fully functional as soon as it is connected to the network. XiO Cloud is built on the Microsoft® Azure® software platform and utilizes Microsoft's industry leading Azure IoT Hub technology. XiO Cloud enables installers and IT managers to deploy and manage thousands of devices in the time it previously took to manage just one. Unlike other virtual machine based cloud solutions, Azure services offer unlimited scalability to suit the ever growing needs of an enterprise. For more information, visit www.crestron.com/xiocloud.

.AV Framework Software

The CP4N provides native support for the .AV Framework™ software program. .AV Framework software is a web-based management solution that is used to deploy scalable Crestron® enterprise room solutions without requiring any programming. For more information on the capabilities supported by .AV Framework, visit www.crestron.com/avframework.

Enhanced Enterprise-Grade Security

The CP4N is an enterprise-class control processor that can be deployed across hundreds of spaces and set up easily using a web browser, [Crestron Toolbox™ software](#), or XiO Cloud. It employs standard network security protocols, including 802.1X network access control, Active Directory® service authentication, SSH, TLS, and HTTPS to ensure reliability and compliance with your organization's IT policies.

The CP4N is configured to meet Crestron's enhanced security standards right out of the box. The CP4N ships with authentication turned on and requires creating an administrator account before access is granted to device configuration and control interfaces.

SNMP V3 Support

Built-in SNMP V3 support permits integration with third-party IT management software, allowing network administrators to manage and control Crestron systems on the network in an IT-friendly format.

BACnet Support

Native support for the BACnet™ communication protocol provides a direct interface to third-party building management systems over Ethernet, simplifying integration with HVAC, security, and other systems. Using BACnet, each system runs independently but communicates together on one platform.¹

Apple HomeKit Integration

The CP4N supports integration with an Apple® HomeKit® technology system. Once the CP4N is paired with a HomeKit system via [SIMPL](#) programming, a Crestron [TSR-310](#) can be used to control supported Apple devices. A pairing QR code is affixed to the CP4N that makes it easy to pair the control system directly to the Apple Home app.²

Notes:

1. A BACnet and IP license is required. A free license is available to support up to 50 BACnet objects on a single 4-Series control system. Support for more than 50 BACnet objects requires the purchase of one [SW-3SERIES-BACNET-50+](#) license. The CP4N supports a maximum of 1000 BACnet objects when dedicated for BACnet use only. Actual capabilities are contingent upon the overall program size and complexity. To obtain the license, visit www.crestron.com/bacnetlicense.
2. This feature is only available when using the TSR-310. Other Crestron touch screens, handheld remotes, and keypads are not supported. For these interfaces, traditional IR or CEC control must be used to control supported Apple devices.

CP4-R Features

The Crestron CP4-R is a secure, high-performance, rack-mountable control processor with the embedded Crestron Home® operating system. It is designed exclusively to function as the core of a Crestron Home system, and features enhanced processing power to handle larger home automation, home theater, multiroom video, and MDU (multidwelling unit) applications. The CP4-R comes equipped with a 4-Series™ multicore CPU processor that delivers remarkable speed and performance while handling the demands of an advanced automated system.



Key features include:

- Advanced 4-Series™ control system designed exclusively for Crestron Home® OS
- 4 GB SDRAM and 8 GB Flash Memory
- 4-Series multicore CPU processor delivers remarkable speed and performance
- Crestron Home Setup and Crestron Home apps provide a simple and real-time setup experience
- Includes built-in IR/serial, COM, I/O, relay, Cresnet® network, and high-speed gigabit Ethernet control ports
- Single-space 19 in. rack mountable

Overview

Through its onboard control ports, the CP4-R allows Crestron Home to integrate with a variety of audio, video, lighting, motorized shades, thermostats, door locks, sensors, and other equipment. Integration with a security system is supported using the optional COM port expanders ([CEN-IO-COM-102](#) or [CEN-IO-COM-202](#)). Native support for BACnet™ communications provides a direct interface to third-party building management systems over Ethernet, simplifying integration with HVAC, security, and other systems.¹

Crestron Home unlocks the full potential of a smart home. It provides dealers with the ability to deliver a simple and clean user interface that includes sophisticated page designs; fluid dynamic room controls; and powerful features such support for multiple homes, favorites, custom access, and room image customizations. The CP4-R can be upgraded from Crestron Pyng® OS 2 to Crestron Home OS via a firmware upgrade.

Refer to www.crestron.com/crestronhome for more information about Crestron Home and for a list of supported Crestron and third-party equipment.²

Notes:

1. Up to 2000 BACnet objects are supported out of the box with no licensing required.
2. Support for infiNET EX® network wireless devices is enabled by adding an infiNET EX wireless gateway ([CEN-GWEXER](#) or [CENI-GWEXER](#) sold separately).
3. The Cresnet™ port (NET) is strictly for use with specific Crestron® devices that work with Crestron Home® OS. In addition to Cresnet or Ethernet, many Crestron wireless devices are also supported by adding an infiNET EX wireless gateway. For a list of Crestron Home compatible devices, please visit: www.crestron.com/crestronhome.

DIN-AP4 Features

The DIN-AP4 is a secure, high-performance control processor with a powerful 4-Series™ control engine designed specifically for DIN rail mounting applications. The DIN-AP4 is designed to integrate and automate technology within any modern networked home, commercial building, or government facility. DIN rail mounting provides a space-efficient, cost-effective, and modular solution for configuring complete automation systems using the DIN-AP4 along with additional Crestron and third-party DIN rail mountable devices.

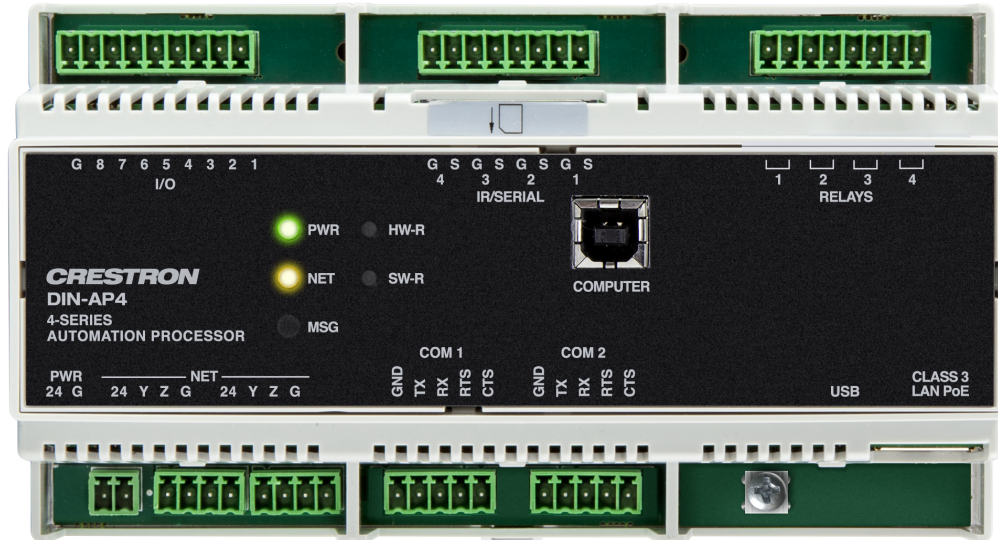

Key features include:

- 4-Series™ control system with 1 GB SDRAM and 8 GB flash memory
- Embedded 4-Series multicore CPU processor
- iPhone®, iPad®, and Android™ device control app support
- XPanel computer and web based control
- Modular programming architecture
- Onboard IR/Serial, COM, I/O, relay, Cresnet® network, and Ethernet control ports
- High-speed USB 2.0 host port and memory card slot
- Support for Crestron Fusion® software and XiO Cloud® service
- Native .AV Framework™ software program
- Enterprise-class network security and authentication
- SNMP V3 remote IT management support
- Native BACnet network/IP support
- Installer setup via software, web browser, or cloud

- IPv6 ready
- Integrates with Apple® HomeKit® technology
- Powered via 24VDC power pack or PoE (Power over Ethernet)
- 9M wide DIN rail mountable

4-Series Control Engine

4-Series control systems come equipped with an upgraded multicore CPU, delivering a sizable speed and performance increase compared to all Crestron 3-Series® control processors. The improved performance allows 4-Series control systems to handle the increasing demands of an advanced automated system. Crestron 4-Series delivers a dynamic and secure control system platform capable of managing a room full of disparate technologies.

Reliable networking and IP control afford seamless integration with other systems and devices, with add-on control capability using Crestron touch screens, wireless remotes, and mobile device apps, as well as remote management through Crestron Fusion® software and the XiO Cloud® service.

Modular Programming Architecture

The DIN-AP4 provides a modular programming architecture that allows the DIN-AP4 to run up to ten programs simultaneously. Programmers can develop and run independent, device-specific programs, enabling each program to be optimized for a specific function and allowing for changes to be made to one program without affecting the whole system.

Onboard Control Ports

Through a full complement of onboard control ports, the DIN-AP4 can be integrated with audio, video, lighting, motorized shades, thermostats, door locks, sensors, security systems, and other equipment.

- Ethernet provides an interface for connecting to the building network and controlling Crestron AV switchers, audio processors, power controllers, and other IP controllable equipment.
- Cresnet® network connectivity provides support for Crestron lighting dimmers, motorized shades, sensors, thermostats, keypads, and more.
- Onboard RS-232, IR/serial, relay, and Versiport I/O control ports enable direct integration with all types of third-party equipment.

Cresnet Network

Cresnet provides a dependable network wiring solution with simple configuration, carrying bidirectional communication and 24VDC power to each connected device over a 4-conductor cable. The DIN-AP4 includes a pair of Cresnet server ports (paralleled) capable of supporting approximately 25 standard devices. Larger systems with more than 25 devices are supported by adding a [DIN-HUB](#) Cresnet distribution hub or a [DIN-CENCN-2](#) Ethernet to Cresnet bridge. Connectivity for multiple wiring runs is facilitated using one or more [DIN-BLOCK](#) Cresnet distribution blocks.

Crestron Fusion Room Monitoring and Scheduling

Crestron Fusion software provides an integrated platform for creating smart buildings that save energy and enhance worker productivity. As part of a complete managed network in a corporate enterprise, college campus, convention center, or any other facility, the DIN-AP4 works with Crestron Fusion to enable remote scheduling, monitoring, and control of rooms and technology from a central help desk or mobile app. It also enables organizations to reduce energy consumption by tracking real-time usage and automating control of AV, lighting, shades, and HVAC. For more information, visit www.crestron.com/fusion.

XiO Cloud Provisioning and Management

4-Series control systems leverage the power and flexibility of XiO Cloud services, enabling users to remotely provision, monitor, and manage Crestron devices across an enterprise network. XiO Cloud can be used to configure and load programs to the control system before it is received, making the control system fully functional as soon as it is connected to the network. XiO Cloud is built on the Microsoft® Azure® software platform and utilizes Microsoft's industry leading Azure IoT Hub technology. XiO Cloud enables installers and IT managers to deploy and manage thousands of devices in the time it previously took to manage just one. Unlike other virtual machine based cloud solutions, Azure services offer unlimited scalability to suit the ever growing needs of an enterprise. For more information, visit www.crestron.com/xiocloud.

.AV Framework Software

The DIN-AP4 provides native support for the .AV Framework™ software program. .AV Framework software is a web-based management solution that is used to deploy scalable Crestron® enterprise room solutions without requiring any programming. For more information on the capabilities supported by .AV Framework, visit www.crestron.com/avframework.

Enhanced Enterprise-Grade Security

The DIN-AP4 is an enterprise-class control processor that can be deployed across hundreds of spaces and set up easily using a web browser, [Crestron Toolbox™ software](#), or XiO Cloud. It employs standard network security protocols, including 802.1X network access control, Active Directory® service authentication, SSH, TLS, and HTTPS to ensure reliability and compliance with your organization's IT policies.

The DIN-AP4 is configured to meet Crestron's enhanced security standards right out of the box. The DIN-AP4 ships with authentication turned on and requires creating an administrator account before access is granted to device configuration and control interfaces.

SNMP V3 Support

Built-in SNMP V3 support permits integration with third-party IT management software, allowing network administrators to manage and control Crestron systems on the network in an IT-friendly format.

BACnet Support

Native support for the BACnet™ communication protocol provides a direct interface to third-party building management systems over Ethernet, simplifying integration with HVAC, security, and other systems. Using BACnet, each system runs independently but communicates together on one platform.¹

Apple HomeKit Integration

The DIN-AP4 supports integration with an Apple® HomeKit® technology system. Once the DIN-AP4 is paired with a HomeKit system via [SIMPL](#) programming, a Crestron [TSR-310](#) can be used to control supported Apple devices. A pairing QR code is affixed to the DIN-AP4 that makes it easy to pair the control system directly to the Apple Home app.²

Versatile Power Options

The DIN-AP4 can be powered using a 24VDC power supply ([DIN-PWS30-277](#) or equivalent) or via PoE (Power over Ethernet). Using PoE technology, the DIN-AP4 receives operating power directly through the LAN wiring. A PoE injector ([PWE-4803RU](#)) connects in line with the LAN cable at a convenient location. Crestron PoE switches ([CEN-SW-POE-5](#) or [CEN-SWPOE-16](#)) may also be used to provide a total networking solution with built-in PoE.

DIN Rail Mounting

The DIN-AP4 is designed to attach to a standard DIN rail for installation in a wall mount enclosure (Crestron [DIN-EN](#) series or similar) or on a wall panel as part of a complete DIN rail automation system.

Notes:

1. A BACnet and IP license is required. A free license is available to support up to 50 BACnet objects on a single 4-Series control system. Support for more than 50 BACnet objects requires the purchase of one [SW-3SERIES-BACNET-50+](#) license. The DIN-AP4 supports a maximum of 500 BACnet objects when dedicated for BACnet use only. Actual capabilities are contingent upon the overall program size and complexity. To obtain the license, visit www.crestron.com/bacnetlicense.
2. This feature is only available when using the TSR-310. Other Crestron touch screens, handheld remotes, and keypads are not supported. For these interfaces, traditional IR or CEC control must be used to control supported Apple devices.

DIN-AP4-R Features

The Crestron DIN-AP4-R is a secure, high-performance control system with a powerful 4-Series™ control engine designed specifically for DIN rail mounting applications. It is designed exclusively to function as the core of a Crestron Home system, and features enhanced processing power to handle small to medium sized home automation, home theater, multiroom video, and MDU (multidwelling unit) applications. The 4-Series® Control Systems comes equipped with a 4-Series multicore CPU processor that delivers remarkable speed and performance while handling the demands of an advanced automated system.

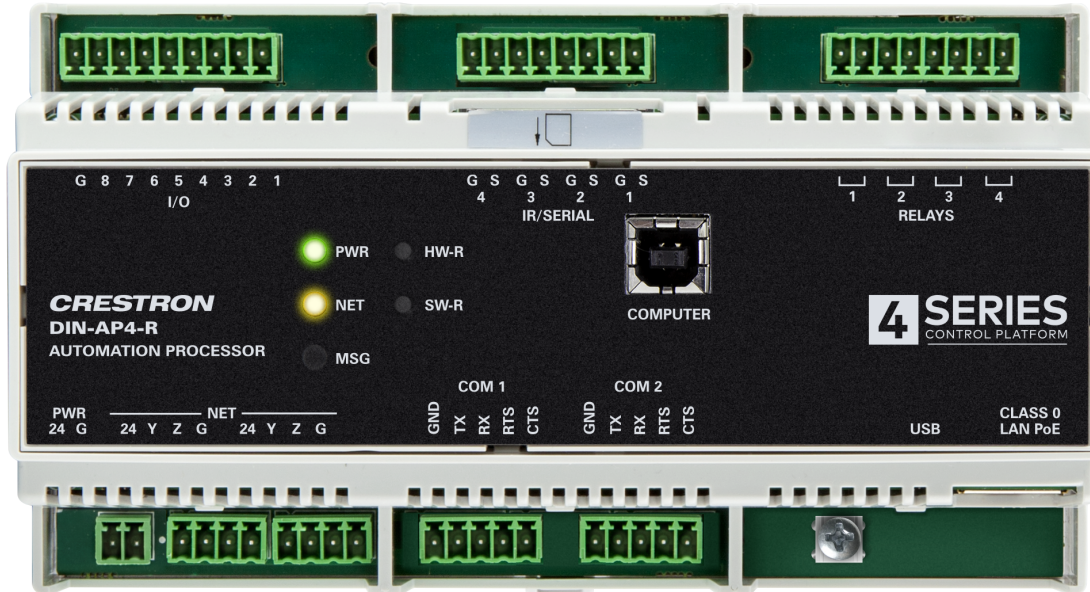

Key features include:

- 4-Series™ control system designed exclusively for Crestron Home® OS
- 2 GB SDRAM and 8 GB Flash Memory
- 4-Series multicore CPU processor delivers remarkable speed and performance
- Crestron Home Setup and Crestron Home apps provide a simple and real-time setup experience
- Includes built-in IR/serial, COM, I/O, relay, Cresnet® network, and high-speed gigabit Ethernet control ports
- Powered via 24VDC power supply or PoE (Power over Ethernet)
- 9M wide DIN rail mountable

Built-In Crestron Home OS

Crestron Home unlocks the full potential of a smart home. It provides dealers with the ability to deliver a sleek user interface that includes fluid dynamic room controls and new features such as support for multiple homes, favorites, custom access, room image customizations, and more.

Refer to www.crestron.com/crestronhome for more information about Crestron Home and for a list of supported Crestron and third-party equipment.²

Wired and Wireless Device Support

Through a full complement of onboard control ports, the DIN-AP4-R allows Crestron Home to integrate with a wide variety of audio, video, lighting, motorized shades, thermostats, door locks, sensors, security systems, and other equipment.

System expansion is made easy using the CEN-IO series of wired Ethernet and Wi-Fi® network I/O extenders (sold separately), which provide additional COM ([CEN-IO-COM-102](#) and [CEN-IO-COM-202](#)), digital input ([CEN-IO-DIGIN-104](#) and [CEN-IO-DIGIN-204](#)), IR ([CEN-IO-IR-104](#) and [CEN-IO-IR-204](#)), or relay ([CEN-IO-RY-104](#) and [CEN-IO-RY-204](#)) ports for integration with all kinds of third-party equipment.

BACnet Support

Native support for the BACnet™ communication protocol provides a direct interface to third-party building management systems over Ethernet, simplifying integration with HVAC, security, and other systems. Using BACnet, each system runs independently but communicates together on one platform.¹

Versatile Power Options

The DIN-AP4-R can be powered using a 24VDC power supply ([DIN-PWS30-277](#) or equivalent) or via PoE (Power over Ethernet). Using PoE technology, the DIN-AP4-R receives operating power directly through the LAN wiring. A PoE injector ([PWE-4803RU](#)) connects in line with the LAN cable at a convenient location. Crestron PoE switches ([CEN-SW-POE-5](#) or [CEN-SWPOE-16](#)) may also be used to provide a total networking solution with built-in PoE.

DIN Rail Mounting

The DIN-AP4-R is designed to attach to a standard DIN rail for installation in a wall mount enclosure (Crestron [DIN-EN](#) series or similar) or on a wall panel as part of a complete DIN rail automation system.

Notes:

1. Up to 500 BACnet objects are supported out of the box with no licensing required.
2. Support for infiNET EX® network wireless devices is enabled by adding an infiNET EX wireless gateway ([CEN-GWEXER](#) or [CENI-GWEXER](#) sold separately).
3. The Cresnet™ port (NET) is strictly for use with specific Crestron® devices that work with Crestron Home® OS. In addition to Cresnet or Ethernet, many Crestron wireless devices are also supported by adding an infiNET EX wireless gateway. For a list of Crestron Home compatible devices, please visit: www.crestron.com/crestronhome.

MC4 Features

The MC4 is a secure, high-performance, cost-effective control processor with a powerful 4-Series™ control engine. Its small form factor and versatile mounting options makes it ideal for smaller systems such as single-room media systems, small to medium-sized homes and offices, and MDUs (multidwelling units). The MC4 includes a built-in infiNET EX® and ER wireless gateway for acquiring wireless devices as well as control ports for controlling wired devices.



Key features include:

- 4-Series™ control system with 1 GB SDRAM and 4 GB flash memory
- Embedded 4-Series multicore CPU processor
- iPhone®, iPad®, and Android™ device control app support
- XPanel computer and web based control
- Modular programming architecture (optional)
- Onboard IR/Serial, COM, I/O, relay, Cresnet® network, and high-speed gigabit Ethernet control ports
- High-speed USB 2.0 host port and rear panel memory card slot
- Support for Crestron Fusion® software and XiO Cloud® service
- Native .AV Framework™ software program
- Enterprise-class network security and authentication
- SNMP V3 remote IT management support
- Native BACnet network/IP support
- Installer setup via software, web browser, or cloud
- IPv6 ready
- Integrates with Apple® HomeKit® technology
- PoE (Power over Ethernet) powered
- Rack or surface mountable

4-Series Control Engine

4-Series control systems come equipped with an upgraded multicore CPU, delivering a sizable speed and performance increase compared to all Crestron 3-Series® control processors. The improved performance allows 4-Series control systems to handle the increasing demands of an advanced automated system. Crestron 4-Series delivers a dynamic and secure control system platform capable of managing a room full of disparate technologies.

Reliable networking and IP control afford seamless integration with other systems and devices, with add-on control capability using Crestron touch screens, wireless remotes, and mobile device apps, as well as remote management through Crestron Fusion® software and the XiO Cloud® service.

Modular Programming Architecture

The MC4 is designed to run a single program out of the box. The optional modular programming architecture add-on allows the MC4 to run up to ten programs simultaneously.¹ Programmers can develop and run independent, device-specific programs, enabling each program to be optimized for a specific function and allowing for changes to be made to one program without affecting the whole system.

Onboard Control Ports

Through a full complement of onboard control ports, the MC4 can be integrated with audio, video, lighting, motorized shades, thermostats, door locks, sensors, security systems, and other equipment.

- Gigabit Ethernet provides an interface for connecting to the building network and controlling Crestron AV switchers, audio processors, power controllers, and other IP controllable equipment.
- Cresnet® network connectivity provides support for Crestron lighting dimmers, motorized shades, sensors, thermostats, keypads, and more.
- Onboard RS-232, IR/serial, relay, and Versiport I/O control ports enable direct integration with all types of third-party equipment.

Expanded connectivity can be provided to the MC4 via Crestron [control port expansion modules](#), [Ethernet to Cresnet bridges](#), [wired Ethernet I/O modules](#), [wireless network I/O modules](#), or [infiNET EX® network wireless gateways](#).

Built-In Wireless Gateway

The MC4 provides a built-in infiNET EX wireless gateway that allows wireless infiNET EX and ER (extended range) devices to be paired directly to the control system.

infiNET EX Technology

Integrated infiNET EX technology provides a cost-effective way to control various functions using infiNET EX based wireless products. infiNET EX wireless technology provides 2-way RF communications throughout a structure without the need for physical control wiring. Employing a 2.4 GHz mesh network topology, nearly every infiNET EX device on the network acts as an

expander, relaying wireless commands between the gateway and all the other EX devices on the network to ensure that every command reaches its intended destination without disruption.²

Extended Range (ER) Technology

Crestron Extended Range (ER) wireless technology supports compatibility with certain Crestron wireless touch screens and handheld remotes. Crestron ER operates in the same 2.4 GHz spectrum as infiNET EX and is optimized specifically for use with wireless touch screen devices to ensure dependable bidirectional RF communications.

IR Wireless Options

When equipped with the optional [CNXRMIRD](#) IR Receiver, the MC4 affords a low-cost IR wireless control solution using a universal IR remote.

Crestron Fusion Room Monitoring and Scheduling

Crestron Fusion software provides an integrated platform for creating smart buildings that save energy and enhance worker productivity. As part of a complete managed network in a corporate enterprise, college campus, convention center, or any other facility, the MC4 works with Crestron Fusion to enable remote scheduling, monitoring, and control of rooms and technology from a central help desk or mobile app. It also enables organizations to reduce energy consumption by tracking real-time usage and automating control of AV, lighting, shades, and HVAC. For more information, visit www.crestron.com/fusion.

XiO Cloud Provisioning and Management

4-Series control systems leverage the power and flexibility of XiO Cloud services, enabling users to remotely provision, monitor, and manage Crestron devices across an enterprise network. XiO Cloud can be used to configure and load programs to the control system before it is received, making the control system fully functional as soon as it is connected to the network. XiO Cloud is built on the Microsoft® Azure® software platform and utilizes Microsoft's industry leading Azure IoT Hub technology. XiO Cloud enables installers and IT managers to deploy and manage thousands of devices in the time it previously took to manage just one. Unlike other virtual machine based cloud solutions, Azure services offer unlimited scalability to suit the ever growing needs of an enterprise. For more information, visit www.crestron.com/xiocloud.

.AV Framework Software

The MC4 provides native support for the .AV Framework™ software program. .AV Framework software is a web-based management solution that is used to deploy scalable Crestron® enterprise room solutions without requiring any programming. For more information on the capabilities supported by .AV Framework, visit www.crestron.com/avframework.

Enhanced Enterprise-Grade Security

The MC4 is an enterprise-class control processor that can be deployed across hundreds of spaces and set up easily using a web browser, [Crestron Toolbox™ software](#), or XiO Cloud. It employs standard network security protocols, including 802.1X network access control, Active Directory® service authentication, SSH, TLS, and HTTPS to ensure reliability and compliance with your organization's IT policies.

The MC4 is configured to meet Crestron's enhanced security standards right out of the box. The MC4 ships with authentication turned on and requires creating an administrator account before access is granted to device configuration and control interfaces.

SNMP V3 Support

Built-in SNMP V3 support permits integration with third-party IT management software, allowing network administrators to manage and control Crestron systems on the network in an IT-friendly format.

BACnet Support

Native support for the BACnet™ communication protocol provides a direct interface to third-party building management systems over Ethernet, simplifying integration with HVAC, security, and other systems. Using BACnet, each system runs independently but communicates together on one platform.³

Apple HomeKit Integration

The MC4 supports integration with an Apple® HomeKit® technology system. Once the MC4 is paired with a HomeKit system via [SIMPL](#) programming, a Crestron [TSR-310](#) can be used to control supported Apple devices. A pairing QR code is affixed to the MC4 that makes it easy to pair the control system directly to the Apple Home app.⁴

PoE Network Powered

Using PoE technology, the MC4 gets its operating power directly through the LAN wiring, eliminating the need for a local power supply or dedicated power wiring. A PoE injector ([PWE-4803RU](#)) connects in line with the LAN cable at a convenient location. Crestron PoE switches ([CEN-SW-POE-5](#) or [CEN-SWPOE-16](#)) may also be used to provide a total networking solution with built-in PoE.

NOTE: Ethernet speed is limited to 100 Mbps when using the PWE-4803RU accessory.

Versatile Mounting Options

The MC4 mounts conveniently to a wall, ceiling, or other flat surface. Its compact, surface-mountable form factor fits easily behind a flat panel display, beneath a tabletop, or inside other furniture, making it ideal for single-room systems. It can even be installed into an equipment rack using the included rack ears or can be attached to a single rack rail.

Notes:

1. Modular Programming Architecture (MPA) on the MC4 requires the purchase of one [SW-RMC3-10PROG](#) license. The license enables support for running up to 10 simultaneous programs on a single MC4. The license is not required if only one program is run on the MC4. To obtain a license for the MC4, complete the [Request for SW-RMC3-10PROG License form](#). For questions, contact license@crestron.com.

2. The total range of an infiNET EX® wireless network is dependent on the placement and capabilities of each network device. A mesh network topology is employed so every EX device on the network acts as a routing node or expander, which relays the signals it receives on to other EX devices within range. This effectively extends the total range of the network and provides multiple redundant signal paths for extra reliability. A maximum of six hops across routing nodes is allowed, although a maximum of three is recommended. Battery-powered infiNET EX devices only operate as leaf nodes and do not provide expander functionality. Up to 100 infiNET EX devices are permitted, although best practices suggest a limit of 50. Up to 15 external gateways ([CEN-GWEXER](#)) may be added to support additional devices (RF conditions allowing). Refer to the [Installation and Setup of Crestron RF Products Best Practices Guide](#) for additional guidelines.
3. A BACnet and IP license is required. A free license is available to support up to 50 BACnet objects on a single 4-Series control system. Support for more than 50 BACnet objects requires the purchase of one [SW-3SERIES-BACNET-50+](#) license. The MC4 supports a maximum of 500 BACnet objects when dedicated for BACnet use only. Actual capabilities are contingent upon the overall program size and complexity. To obtain the license, visit www.crestron.com/bacnetlicense.
4. This feature is only available when using the TSR-310. Other Crestron touch screens, handheld remotes, and keypads are not supported. For these interfaces, traditional IR or CEC control must be used to control supported Apple devices.

MC4-I Features

The MC4-I is a secure, high-performance, cost-effective control processor with a powerful 4-Series™ control engine. Its small form factor and versatile mounting options makes it ideal for smaller systems such as single-room media systems, small to medium-sized homes and offices, and MDUs (multidwelling units). The MC4-I includes a built-in infiNET EX® and ER wireless gateway for acquiring wireless devices as well as control ports for controlling wired devices.



Key features include:

- 4-Series™ control system with 1 GB SDRAM and 4 GB flash memory
- Embedded 4-Series multicore CPU processor
- iPhone®, iPad®, and Android™ device control app support
- XPanel computer and web based control
- Modular programming architecture (optional)
- Onboard IR/Serial, COM, I/O, relay, Cresnet® network, and high-speed gigabit Ethernet control ports
- High-speed USB 2.0 host port and rear panel memory card slot
- Support for Crestron Fusion® software and XiO Cloud® service
- Native .AV Framework™ software program
- Enterprise-class network security and authentication
- SNMP V3 remote IT management support
- Native BACnet network/IP support
- Installer setup via software, web browser, or cloud
- IPv6 ready
- Integrates with Apple® HomeKit® technology
- PoE (Power over Ethernet) powered
- Rack or surface mountable

4-Series Control Engine

4-Series control systems come equipped with an upgraded multicore CPU, delivering a sizable speed and performance increase compared to all Crestron 3-Series® control processors. The improved performance allows 4-Series control systems to handle the increasing demands of an advanced automated system. Crestron 4-Series delivers a dynamic and secure control system platform capable of managing a room full of disparate technologies.

Reliable networking and IP control afford seamless integration with other systems and devices, with add-on control capability using Crestron touch screens, wireless remotes, and mobile device apps, as well as remote management through Crestron Fusion® software and the XiO Cloud® service.

Modular Programming Architecture

The MC4-I is designed to run a single program out of the box. The optional modular programming architecture add-on allows the MC4-I to run up to ten programs simultaneously.¹ Programmers can develop and run independent, device-specific programs, enabling each program to be optimized for a specific function and allowing for changes to be made to one program without affecting the whole system.

Onboard Control Ports

Through a full complement of onboard control ports, the MC4-I can be integrated with audio, video, lighting, motorized shades, thermostats, door locks, sensors, security systems, and other equipment.

- Gigabit Ethernet provides an interface for connecting to the building network and controlling Crestron AV switchers, audio processors, power controllers, and other IP controllable equipment.
- Cresnet® network connectivity provides support for Crestron lighting dimmers, motorized shades, sensors, thermostats, keypads, and more.
- Onboard RS-232, IR/serial, relay, and Versiport I/O control ports enable direct integration with all types of third-party equipment.

Expanded connectivity can be provided to the MC4-I via Crestron [control port expansion modules](#), [Ethernet to Cresnet bridges](#), [wired Ethernet I/O modules](#), [wireless network I/O modules](#), or [infiNET EX® network wireless gateways](#).

Built-In Wireless Gateway

The MC4-I provides a built-in infiNET EX wireless gateway that allows wireless infiNET EX and ER (extended range) devices to be paired directly to the control system.

infiNET EX Technology

Integrated infiNET EX technology provides a cost-effective way to control various functions using infiNET EX based wireless products. infiNET EX wireless technology provides 2-way RF communications throughout a structure without the need for physical control wiring. Employing a 2.4 GHz mesh network topology, nearly every infiNET EX device on the network acts as an

expander, relaying wireless commands between the gateway and all the other EX devices on the network to ensure that every command reaches its intended destination without disruption.²

Extended Range (ER) Technology

Crestron Extended Range (ER) wireless technology supports compatibility with certain Crestron wireless touch screens and handheld remotes. Crestron ER operates in the same 2.4 GHz spectrum as infiNET EX and is optimized specifically for use with wireless touch screen devices to ensure dependable bidirectional RF communications.

IR Wireless Options

When equipped with the optional [CNXRMIRD](#) IR Receiver, the MC4 affords a low-cost IR wireless control solution using a universal IR remote.

Crestron Fusion Room Monitoring and Scheduling

Crestron Fusion software provides an integrated platform for creating smart buildings that save energy and enhance worker productivity. As part of a complete managed network in a corporate enterprise, college campus, convention center, or any other facility, the MC4-I works with Crestron Fusion to enable remote scheduling, monitoring, and control of rooms and technology from a central help desk or mobile app. It also enables organizations to reduce energy consumption by tracking real-time usage and automating control of AV, lighting, shades, and HVAC. For more information, visit www.crestron.com/fusion.

XiO Cloud Provisioning and Management

4-Series control systems leverage the power and flexibility of XiO Cloud services, enabling users to remotely provision, monitor, and manage Crestron devices across an enterprise network. XiO Cloud can be used to configure and load programs to the control system before it is received, making the control system fully functional as soon as it is connected to the network. XiO Cloud is built on the Microsoft® Azure® software platform and utilizes Microsoft's industry leading Azure IoT Hub technology. XiO Cloud enables installers and IT managers to deploy and manage thousands of devices in the time it previously took to manage just one. Unlike other virtual machine based cloud solutions, Azure services offer unlimited scalability to suit the ever growing needs of an enterprise. For more information, visit www.crestron.com/xiocloud.

.AV Framework Software

The MC4-I provides native support for the .AV Framework™ software program. .AV Framework software is a web-based management solution that is used to deploy scalable Crestron® enterprise room solutions without requiring any programming. For more information on the capabilities supported by .AV Framework, visit www.crestron.com/avframework.

Enhanced Enterprise-Grade Security

The MC4-I is an enterprise-class control processor that can be deployed across hundreds of spaces and set up easily using a web browser, [Crestron Toolbox™ software](#), or XiO Cloud. It employs standard network security protocols, including 802.1X network access control, Active Directory® service authentication, SSH, TLS, and HTTPS to ensure reliability and compliance with your organization's IT policies.

The MC4-I is configured to meet Crestron's enhanced security standards right out of the box. The MC4-I ships with authentication turned on and requires creating an administrator account before access is granted to device configuration and control interfaces.

SNMP V3 Support

Built-in SNMP V3 support permits integration with third-party IT management software, allowing network administrators to manage and control Crestron systems on the network in an IT-friendly format.

BACnet Support

Native support for the BACnet™ communication protocol provides a direct interface to third-party building management systems over Ethernet, simplifying integration with HVAC, security, and other systems. Using BACnet, each system runs independently but communicates together on one platform.³

Apple HomeKit Integration

The MC4-I supports integration with an Apple® HomeKit® technology system. Once the MC4-I is paired with a HomeKit system via [SIMPL](#) programming, a Crestron [TSR-310](#) can be used to control supported Apple devices. A pairing QR code is affixed to the MC4-I that makes it easy to pair the control system directly to the Apple Home app.⁴

PoE Network Powered

Using PoE technology, the MC4-I gets its operating power directly through the LAN wiring, eliminating the need for a local power supply or dedicated power wiring. A PoE injector ([PWE-4803RU](#)) connects in line with the LAN cable at a convenient location. Crestron PoE switches ([CEN-SW-POE-5](#) or [CEN-SWPOE-16](#)) may also be used to provide a total networking solution with built-in PoE.

NOTE: Ethernet speed is limited to 100 Mbps when using the PWE-4803RU accessory.

Versatile Mounting Options

The MC4-I mounts conveniently to a wall, ceiling, or other flat surface. Its compact, surface-mountable form factor fits easily behind a flat panel display, beneath a tabletop, or inside other furniture, making it ideal for single-room systems. It can even be installed into an equipment rack using the included rack ears or can be attached to a single rack rail.

Notes:

1. Modular Programming Architecture (MPA) on the MC4-I requires the purchase of one [SW-RMC3-10PROG](#) license. The license enables support for running up to 10 simultaneous programs on a single MC4-I. The license is not required if only one program is run on the MC4-I. To obtain a license for the MC4-I, complete the [Request for SW-RMC3-10PROG License form](#). For questions, contact license@crestron.com.

2. The total range of an infiNET EX® wireless network is dependent on the placement and capabilities of each network device. A mesh network topology is employed so every EX device on the network acts as a routing node or expander, which relays the signals it receives on to other EX devices within range. This effectively extends the total range of the network and provides multiple redundant signal paths for extra reliability. A maximum of six hops across routing nodes is allowed, although a maximum of three is recommended. Battery-powered infiNET EX devices only operate as leaf nodes and do not provide expander functionality. Up to 100 infiNET EX devices are permitted, although best practices suggest a limit of 50. Up to 15 external gateways ([CEN-GWEXER](#)) may be added to support additional devices (RF conditions allowing). Refer to the [Installation and Setup of Crestron RF Products Best Practices Guide](#) for additional guidelines.
3. A BACnet and IP license is required. A free license is available to support up to 50 BACnet objects on a single 4-Series control system. Support for more than 50 BACnet objects requires the purchase of one [SW-3SERIES-BACNET-50+](#) license. The MC4-I supports a maximum of 500 BACnet objects when dedicated for BACnet use only. Actual capabilities are contingent upon the overall program size and complexity. To obtain the license, visit www.crestron.com/bacnetlicense.
4. This feature is only available when using the TSR-310. Other Crestron touch screens, handheld remotes, and keypads are not supported. For these interfaces, traditional IR or CEC control must be used to control supported Apple devices.

MC4-R Features

The Crestron MC4-R provides a secure, high-performance, cost-effective control system with the embedded Crestron Home® operating system. Its small form factor and versatile mounting options makes it ideal for smaller Crestron Home systems such as single-room systems, small to medium-sized homes, and MDUs (multidwelling units). The MC4-R comes equipped with a 4-Series™ multicore CPU processor that delivers remarkable speed and performance while handling the demands of an advanced automated system.

The MC4-R is a perfect replacement for a PYNG-HUB processor when upgrading a smaller system from Crestron Pyng® OS to Crestron Home.

NOTE: For larger homes and systems that require additional processing power, refer instead to the [CP4-R](#) 4-Series Control System for Crestron Home OS.



Key features include:

- Compact 4-Series™ control system designed exclusively for Crestron Home® OS
- 2 GB SDRAM and 8 GB Flash Memory
- 4-Series multicore CPU processor delivers remarkable speed and performance
- Crestron Home Setup and Crestron Home apps provide a simple and real-time setup experience
- Ideal for single-room solutions, small to medium-sized homes, and MDUs (multidwelling units)
- Capable of handling systems with hundreds of devices
- Includes built-in IR, COM, I/O, relay, Cresnet® network, and high-speed gigabit Ethernet control ports
- Built-in infiNET EX® wireless network gateway
- PoE (Power over Ethernet) powered
- Rack or surface mountable

Built-In Crestron Home OS

Crestron Home unlocks the full potential of a smart home. It provides dealers with the ability to deliver a sleek user interface that includes fluid dynamic room controls and new features such as support for multiple homes, favorites, custom access, room image customizations, and more.

Refer to www.crestron.com/crestronhome for more information about Crestron Home and for a list of supported Crestron and third-party equipment.

Wired and Wireless Device Support

Through a full complement of onboard control ports, the MC4-R allows Crestron Home to integrate with a wide variety of audio, video, lighting, motorized shades, thermostats, door locks, sensors, security systems, and other equipment. The MC4-R also provides a built-in infiNET EX® wireless gateway that allows wireless devices to be paired directly to the control system and then added to the Crestron Home system.^{1,2}

System expansion is made easy using the CEN-IO series of wired Ethernet and Wi-Fi® network I/O extenders (sold separately), which provide additional COM ([CEN-IO-COM-102](#) and [CEN-IO-COM-202](#)), digital input ([CEN-IO-DIGIN-104](#) and [CEN-IO-DIGIN-204](#)), IR ([CEN-IO-IR-104](#) and [CEN-IO-IR-204](#)), or relay ([CEN-IO-RY-104](#) and [CEN-IO-RY-204](#)) ports for integration with all kinds of third-party equipment.

BACnet Support

Native support for the BACnet™ communication protocol provides a direct interface to third-party building management systems over Ethernet, simplifying integration with HVAC, security, and other systems. Using BACnet, each system runs independently but communicates together on one platform.³

PoE Powered Network

Using PoE technology, the MC4-R gets its operating power directly through the LAN wiring, eliminating the need for a local power supply or dedicated power wiring. A PoE injector ([PWE-4803RU](#)) connects in line with the LAN cable at a convenient location. Crestron PoE switches ([CEN-SW-POE-5](#) or [CEN-SWPOE-16](#)) may also be used to provide a total networking solution with built-in PoE.

NOTE: Ethernet speed is limited to 100 Mbps when using the PWE-4803RU accessory.

Versatile Mounting Options

The MC4-R mounts conveniently to a wall, ceiling, or other flat surface. Its compact, surface-mountable form factor fits easily behind a flat panel display, beneath a tabletop, or inside other furniture, making it ideal for single-room systems. It can even be installed into an equipment rack using the included rack ears or can be attached to a single rack rail.

Notes:

1. The Cresnet® network port (NET) and infiNET EX® transceiver are strictly for use with specific Crestron® devices that work with Crestron Home® OS. For a list of compatible devices, visit www.crestron.com/crestronhome.

2. The total range of an infiNET EX wireless network is dependent on the placement and capabilities of each network device. A mesh network topology is employed so every "EX" device on the network acts as a routing node or "expander," which relays the signals it receives on to other EX devices within range. This effectively extends the total range of the network and provides multiple redundant signal paths for extra reliability. A maximum of six "hops" across routing nodes is allowed, although a maximum of three is recommended. Battery-powered infiNET EX devices only operate as leaf nodes and do not provide expander functionality. Up to 100 infiNET EX devices are permitted, although best practices suggest a limit of 50. Up to 15 external gateways (CEN-GWEXER sold separately) may be added to support additional devices (RF conditions allowing). Refer to the [Installation and Setup of Crestron RF Products Best Practices Guide](#) for additional guidelines.
3. Up to 2000 BACnet objects are supported out of the box with no licensing required.

MC4-R-I Features

The Crestron MC4-R-I provides a secure, high-performance, cost-effective control system with the embedded Crestron Home® operating system. Its small form factor and versatile mounting options makes it ideal for smaller Crestron Home systems such as single-room systems, small to medium-sized homes, and MDUs (multidwelling units). The MC4-R-I comes equipped with a 4-Series™ multicore CPU processor that delivers remarkable speed and performance while handling the demands of an advanced automated system.

The MC4-R-I is a perfect replacement for a PYNG-HUB processor when upgrading a smaller system from Crestron Pyng® OS to Crestron Home.

NOTE: For larger homes and systems that require additional processing power, refer instead to the [CP4-R](#) 4-Series Control System for Crestron Home OS.



Key features include:

- Compact 4-Series™ control system designed exclusively for Crestron Home® OS
- 2 GB SDRAM and 8 GB Flash Memory
- 4-Series multicore CPU processor delivers remarkable speed and performance
- Crestron Home Setup and Crestron Home apps provide a simple and real-time setup experience
- Ideal for single-room solutions, small to medium-sized homes, and MDUs (multidwelling units)
- Capable of handling systems with hundreds of devices
- Includes built-in IR, COM, I/O, relay, Cresnet® network, and high-speed gigabit Ethernet control ports
- Built-in infiNET EX® wireless network gateway
- PoE (Power over Ethernet) powered
- Rack or surface mountable

Built-In Crestron Home OS

Crestron Home unlocks the full potential of a smart home. It provides dealers with the ability to deliver a sleek user interface that includes fluid dynamic room controls and new features such as support for multiple homes, favorites, custom access, room image customizations, and more.

Refer to www.crestron.com/crestronhome for more information about Crestron Home and for a list of supported Crestron and third-party equipment.

Wired and Wireless Device Support

Through a full complement of onboard control ports, the MC4-R-I allows Crestron Home to integrate with a wide variety of audio, video, lighting, motorized shades, thermostats, door locks, sensors, security systems, and other equipment. The MC4-R-I also provides a built-in infiNET EX® wireless gateway that allows wireless devices to be paired directly to the control system and then added to the Crestron Home system.^{1,2}

System expansion is made easy using the CEN-IO series of wired Ethernet and Wi-Fi® network I/O extenders (sold separately), which provide additional COM ([CEN-IO-COM-102](#) and [CEN-IO-COM-202](#)), digital input ([CEN-IO-DIGIN-104](#) and [CEN-IO-DIGIN-204](#)), IR ([CEN-IO-IR-104](#) and [CEN-IO-IR-204](#)), or relay ([CEN-IO-RY-104](#) and [CEN-IO-RY-204](#)) ports for integration with all kinds of third-party equipment.

BACnet Support

Native support for the BACnet™ communication protocol provides a direct interface to third-party building management systems over Ethernet, simplifying integration with HVAC, security, and other systems. Using BACnet, each system runs independently but communicates together on one platform.³

PoE Powered Network

Using PoE technology, the MC4-R-I gets its operating power directly through the LAN wiring, eliminating the need for a local power supply or dedicated power wiring. A PoE injector ([PWE-4803RU](#)) connects in line with the LAN cable at a convenient location. Crestron PoE switches ([CEN-SW-POE-5](#) or [CEN-SWPOE-16](#)) may also be used to provide a total networking solution with built-in PoE.

NOTE: Ethernet speed is limited to 100 Mbps when using the PWE-4803RU accessory.

Versatile Mounting Options

The MC4-R-I mounts conveniently to a wall, ceiling, or other flat surface. Its compact, surface-mountable form factor fits easily behind a flat panel display, beneath a tabletop, or inside other furniture, making it ideal for single-room systems. It can even be installed into an equipment rack using the included rack ears or can be attached to a single rack rail.

Notes:

1. The Cresnet® network port (NET) and infiNET EX® transceiver are strictly for use with specific Crestron® devices that work with Crestron Home® OS. For a list of compatible devices, visit www.crestron.com/crestronhome.

2. The total range of an infiNET EX wireless network is dependent on the placement and capabilities of each network device. A mesh network topology is employed so every "EX" device on the network acts as a routing node or "expander," which relays the signals it receives on to other EX devices within range. This effectively extends the total range of the network and provides multiple redundant signal paths for extra reliability. A maximum of six "hops" across routing nodes is allowed, although a maximum of three is recommended. Battery-powered infiNET EX devices only operate as leaf nodes and do not provide expander functionality. Up to 100 infiNET EX devices are permitted, although best practices suggest a limit of 50. Up to 15 external gateways (CEN-GWEXER sold separately) may be added to support additional devices (RF conditions allowing). Refer to the [Installation and Setup of Crestron RF Products Best Practices Guide](#) for additional guidelines.
3. Up to 2000 BACnet objects are supported out of the box with no licensing required.

PRO4 Features

The PRO4 is a secure, high-performance control processor with a powerful 4-Series™ control engine and an enhanced feature set, including a front panel color LCD display, built-in control card expansion slots, and dedicated Control Subnet ports. The PRO4 is designed to integrate and automate technology within any modern networked home, commercial building, or government facility. Isolated Control Subnet ports provide a Gigabit Ethernet LAN dedicated to Crestron devices.



Key features include:

- 4-Series™ control system with 2 GB SDRAM and 8 GB flash memory
- Embedded 4-Series multicore CPU processor
- iPhone®, iPad®, and Android™ device control app support
- XPanel computer and web based control
- Modular programming architecture
- Onboard IR/Serial, COM, I/O, relay, Cresnet® network, and high-speed gigabit Ethernet control ports
- Control Subnet ports with PoE+ providing a dedicated local network for Crestron® devices
- High-speed USB 2.0 host port and rear panel memory card slot
- Three control card expansion slots (optional)
- IEC 61000-4-5 Installation Class 4 surge immunity on COM, Versiport, and network connections
- Support for Crestron Fusion® software and XiO Cloud® service
- Native .AV Framework™ software program
- Enterprise-class network security and authentication
- SNMP V3 remote IT management support
- Native BACnet network/IP support
- Installer setup via front panel, software, web browser, or cloud

- IPv6 ready
- Integrates with Apple® HomeKit® technology
- Rack mountable

4-Series Control Engine

4-Series control systems come equipped with an upgraded multicore CPU, delivering a sizable speed and performance increase compared to all Crestron 3-Series® control processors. The improved performance allows 4-Series control systems to handle the increasing demands of an advanced automated system. Crestron 4-Series delivers a dynamic and secure control system platform capable of managing a room full of disparate technologies.

Reliable networking and IP control afford seamless integration with other systems and devices, with add-on control capability using Crestron touch screens, wireless remotes, and mobile device apps, as well as remote management through Crestron Fusion® software and the XiO Cloud® service.

Modular Programming Architecture

The PRO4 provides a modular programming architecture that allows the PRO4 to run up to ten programs simultaneously. Programmers can develop and run independent, device-specific programs, enabling each program to be optimized for a specific function and allowing for changes to be made to one program without affecting the whole system.

Dedicated Control Subnet

The Crestron Control Subnet is a Gigabit Ethernet network dedicated to Crestron devices. Via the Control Subnet ports, an installer can connect up to four touch screens or wireless gateways or can add Crestron PoE switches ([CEN-SW-POE-5](#) or [CEN-SWPOE-16](#)) to handle multiple touch screens, gateways, AV components, and other devices. Each port also supports PoE+ using the optional [PW-5430DUS](#) power supply. Automatic configuration of the entire subnet is performed by the PRO4, discovering each device and assigning IP addresses without any extra effort from the installer.¹

A separate LAN port provides a single-point connection to the local network, requiring only one IP address for the entire control system. The LAN port allows for interconnectivity between devices on the local subnet and other devices, systems, servers, and WAN/internet connections outside the local subnet. For sensitive applications that require heightened security, the entire Control Subnet can be isolated completely from the local network.

Onboard Control Ports

Through a full complement of onboard control ports, the PRO4 can be integrated with audio, video, lighting, motorized shades, thermostats, door locks, sensors, security systems, and other equipment.¹

- Gigabit Ethernet provides an interface for connecting to the building network and controlling Crestron AV switchers, audio processors, power controllers, and other IP controllable equipment.

- Cresnet® network connectivity provides support for Crestron lighting dimmers, motorized shades, sensors, thermostats, keypads, and more.
- Onboard RS-232, IR/serial, relay, and Versiport I/O control ports enable direct integration with all types of third-party equipment.

Expanded connectivity can be provided to the PRO4 via Crestron [control port expansion modules](#), [Ethernet to Cresnet bridges](#), [wired Ethernet I/O modules](#), [wireless network I/O modules](#), or [infiNET EX® network wireless gateways](#).

Crestron Fusion Room Monitoring and Scheduling

Crestron Fusion software provides an integrated platform for creating smart buildings that save energy and enhance worker productivity. As part of a complete managed network in a corporate enterprise, college campus, convention center, or any other facility, the PRO4 works with Crestron Fusion to enable remote scheduling, monitoring, and control of rooms and technology from a central help desk or mobile app. It also enables organizations to reduce energy consumption by tracking real-time usage and automating control of AV, lighting, shades, and HVAC. For more information, visit www.crestron.com/fusion.

XiO Cloud Provisioning and Management

4-Series control systems leverage the power and flexibility of XiO Cloud services, enabling users to remotely provision, monitor, and manage Crestron devices across an enterprise network. XiO Cloud can be used to configure and load programs to the control system before it is received, making the control system fully functional as soon as it is connected to the network. XiO Cloud is built on the Microsoft® Azure® software platform and utilizes Microsoft's industry leading Azure IoT Hub technology. XiO Cloud enables installers and IT managers to deploy and manage thousands of devices in the time it previously took to manage just one. Unlike other virtual machine based cloud solutions, Azure services offer unlimited scalability to suit the ever growing needs of an enterprise. For more information, visit www.crestron.com/xiocloud.

.AV Framework Software

The PRO4 provides native support for the .AV Framework™ software program. .AV Framework software is a web-based management solution that is used to deploy scalable Crestron® enterprise room solutions without requiring any programming. For more information on the capabilities supported by .AV Framework, visit www.crestron.com/avframework.

Enhanced Enterprise-Grade Security

The PRO4 is an enterprise-class control processor that can be deployed across hundreds of spaces and set up easily using a web browser, [Crestron Toolbox™ software](#), or XiO Cloud. It employs standard network security protocols, including 802.1X network access control, Active Directory® service authentication, SSH, TLS, and HTTPS to ensure reliability and compliance with your organization's IT policies.

The PRO4 is configured to meet Crestron's enhanced security standards right out of the box. The PRO4 ships with authentication turned on and requires creating an administrator account before access is granted to device configuration and control interfaces.

SNMP V3 Support

Built-in SNMP V3 support permits integration with third-party IT management software, allowing network administrators to manage and control Crestron systems on the network in an IT-friendly format.

Front Panel LCD Display

The PRO4 front panel includes a color LCD display for performing extensive setup and diagnostics without having to connect a computer.

Control Card Expansion Slots

Additional control ports can be added to the PRO4 using [control cards](#) and the [CAGE3](#) control card expansion cage. The CAGE3 accessory installs into the PRO4, providing three control card expansion slots on the PRO4 rear panel. Adding the CAGE3 option affords significant expansion capability without requiring any additional rack space.

BACnet Support

Native support for the BACnet™ communication protocol provides a direct interface to third-party building management systems over Ethernet, simplifying integration with HVAC, security, and other systems. Using BACnet, each system runs independently but communicates together on one platform.²

Apple HomeKit Integration

The PRO4 supports integration with an Apple® HomeKit® technology system. Once the PRO4 is paired with a HomeKit system via [SIMPL](#) programming, a Crestron [TSR-310](#) can be used to control supported Apple devices. A pairing QR code is affixed to the PRO4 that makes it easy to pair the control system directly to the Apple Home app.³

Notes:

1. The following connections comply with IEC 61000-4-5 Installation Class 4 surge immunity levels: COM 1–6, I/O 1–8, NET, LAN, and CONTROL SUBNET.
2. A BACnet and IP license is required. A free license is available to support up to 50 BACnet objects on a single 4-Series control system. Support for more than 50 BACnet objects requires the purchase of one [SW-3SERIES-BACNET-50+](#) license. The PRO4 supports a maximum of 2000 BACnet objects when dedicated for BACnet use only. Actual capabilities are contingent upon the overall program size and complexity. To obtain the license, visit www.crestron.com/bacnetlicense.
3. This feature is only available when using the TSR-310. Other Crestron touch screens, handheld remotes, and keypads are not supported. For these interfaces, traditional IR or CEC control must be used to control supported Apple devices.

RMC4 Features

The RMC4 is a secure, high-performance, cost-effective control processor with a powerful 4-Series™ control engine. The RMC4 is designed for controlling and monitoring for a single display device, a small AV system, lighting and shading, climate control, security, energy management, and many other specialized applications. A small form factor allows the RMC4 to be placed just about anywhere, with the option to attach it to a flat surface or DIN rail using the included mounting bracket. The RMC4 fits easily behind a video display or above a projector, and provides enough control ports to control the display device along with a screen or lift.



Key features include:

- 4-Series™ control system with 1 GB SDRAM and 8 GB flash memory
- Embedded 4-Series multicore CPU processor
- iPhone®, iPad®, and Android™ device control app support
- XPanel computer and web based control
- Modular programming architecture
- Onboard IR/Serial, COM, I/O, relay, Cresnet® network, and Ethernet control ports
- USB OTG (On-the-Go) port
- Support for Crestron Fusion® software and XiO Cloud® service
- Native .AV Framework™ software program
- Enterprise-class network security and authentication
- SNMP V3 remote IT management support
- Native BACnet network/IP support
- Installer setup via software, web browser, or cloud
- IPv6 ready
- Integrates with Apple® HomeKit® technology
- PoE (Power over Ethernet) powered

- Compact, stackable IFE (Integrator Friendly Enclosure) micro form factor
- Surface or DIN rail mountable
- Optional rack mount and pole mount kits available

4-Series Control Engine

4-Series control systems come equipped with an upgraded multicore CPU, delivering a sizable speed and performance increase compared to all Crestron 3-Series® control processors. The improved performance allows 4-Series control systems to handle the increasing demands of an advanced automated system. Crestron 4-Series delivers a dynamic and secure control system platform capable of managing a room full of disparate technologies.

Reliable networking and IP control afford seamless integration with other systems and devices, with add-on control capability using Crestron touch screens, wireless remotes, and mobile device apps, as well as remote management through Crestron Fusion® software and the XiO Cloud® service.

Modular Programming Architecture

The RMC4 is designed to run a single program out of the box. The optional modular programming architecture add-on allows the RMC4 to run up to ten programs simultaneously.¹ Programmers can develop and run independent, device-specific programs, enabling each program to be optimized for a specific function and allowing for changes to be made to one program without affecting the whole system.

Onboard Control Ports

Through a full complement of onboard control ports, the RMC4 can be integrated with audio, video, lighting, motorized shades, thermostats, door locks, sensors, security systems, and other equipment.

- Ethernet provides an interface for connecting to the building network and controlling Crestron AV switchers, audio processors, power controllers, and other IP controllable equipment.
- Cresnet® network connectivity provides support for Crestron lighting dimmers, motorized shades, sensors, thermostats, keypads, and more.²
- Onboard RS-232, IR/serial, relay, and Versiport I/O control ports enable direct integration with all types of third-party equipment.

Expanded connectivity can be provided to the RMC4 via Crestron [control port expansion modules](#), [Ethernet to Cresnet bridges](#), [wired Ethernet I/O modules](#), [wireless network I/O modules](#), or [infiNET EX® network wireless gateways](#).

Crestron Fusion Room Monitoring and Scheduling

Crestron Fusion software provides an integrated platform for creating smart buildings that save energy and enhance worker productivity. As part of a complete managed network in a corporate enterprise, college campus, convention center, or any other facility, the RMC4 works with Crestron Fusion to enable remote scheduling, monitoring, and control of rooms and technology from a central help desk or mobile app. It also enables organizations to reduce energy

consumption by tracking real-time usage and automating control of AV, lighting, shades, and HVAC. For more information, visit www.crestron.com/fusion.

XiO Cloud Provisioning and Management

4-Series control systems leverage the power and flexibility of XiO Cloud services, enabling users to remotely provision, monitor, and manage Crestron devices across an enterprise network. XiO Cloud can be used to configure and load programs to the control system before it is received, making the control system fully functional as soon as it is connected to the network. XiO Cloud is built on the Microsoft® Azure® software platform and utilizes Microsoft's industry leading Azure IoT Hub technology. XiO Cloud enables installers and IT managers to deploy and manage thousands of devices in the time it previously took to manage just one. Unlike other virtual machine based cloud solutions, Azure services offer unlimited scalability to suit the ever growing needs of an enterprise. For more information, visit www.crestron.com/xiocloud.

.AV Framework Software

The RMC4 provides native support for the .AV Framework™ software program. .AV Framework software is a web-based management solution that is used to deploy scalable Crestron® enterprise room solutions without requiring any programming. For more information on the capabilities supported by .AV Framework, visit www.crestron.com/avframework.

Enhanced Enterprise-Grade Security

The RMC4 is an enterprise-class control processor that can be deployed across hundreds of spaces and set up easily using a web browser, [Crestron Toolbox™ software](#), or XiO Cloud. It employs standard network security protocols, including 802.1X network access control, Active Directory® service authentication, SSH, TLS, and HTTPS to ensure reliability and compliance with your organization's IT policies.

The RMC4 is configured to meet Crestron's enhanced security standards right out of the box. The RMC4 ships with authentication turned on and requires creating an administrator account before access is granted to device configuration and control interfaces.

SNMP V3 Support

Built-in SNMP V3 support permits integration with third-party IT management software, allowing network administrators to manage and control Crestron systems on the network in an IT-friendly format.

BACnet Support

Native support for the BACnet™ communication protocol provides a direct interface to third-party building management systems over Ethernet, simplifying integration with HVAC, security, and other systems. Using BACnet, each system runs independently but communicates together on one platform.³

Apple HomeKit Integration

The RMC4 supports integration with an Apple® HomeKit® technology system. Once the RMC4 is paired with a HomeKit system via [SIMPL](#) programming, a Crestron [TSR-310](#) can be used to control supported Apple devices. A pairing QR code is affixed to the RMC4 that makes it easy to pair the control system directly to the Apple Home app.⁴

PoE Network Powered

Using PoE technology, the RMC4 gets its operating power directly through the LAN wiring, eliminating the need for a local power supply or dedicated power wiring. A PoE injector ([PWE-4803RU](#)) connects in line with the LAN cable at a convenient location. Crestron PoE switches ([CEN-SW-POE-5](#) or [CEN-SWPOE-16](#)) may also be used to provide a total networking solution with built-in PoE.

Integrator Friendly Enclosure

The RMC4 features the Crestron IFE (Integrator Friendly Enclosure) form factor, a compact design that fits almost anywhere and supports a variety of installation options. Its shape allows multiple RMC4 and other IFE compliant devices to be stacked together. Using the included mounting bracket, it can be fastened to a flat surface or snapped onto a standard DIN rail. Rack mount ([RMK-IFE-1U](#)) and pole mount ([PLMK-IFE-101](#)) kits are also available.

Notes:

1. Modular Programming Architecture (MPA) on the RMC4 requires the purchase of one [SW-RMC3-10PROG](#) license. The license enables support for running up to 10 simultaneous programs on a single RMC4. The license is not required if only one program is run on the RMC4. To obtain a license for the RMC4, complete the [Request for SW-RMC3-10PROG License form](#). For questions, contact license@crestron.com.
2. The NET (Cresnet® network) port on the RMC4 is a 3-pin connector which provides connectivity for Cresnet data only, not power. The Cresnet power conductor does not terminate to the RMC4. An external Cresnet power supply is required to provide power for Cresnet devices.
3. A BACnet and IP license is required. A free license is available to support up to 50 BACnet objects on a single 4-Series control system. Support for more than 50 BACnet objects requires the purchase of one [SW-3SERIES-BACNET-50+](#) license. The RMC4 supports a maximum of 500 BACnet objects when dedicated for BACnet use only. Actual capabilities are contingent upon the overall program size and complexity. To obtain the license, visit www.crestron.com/bacnetlicense.
4. This feature is only available when using the TSR-310. Other Crestron touch screens, handheld remotes, and keypads are not supported. For these interfaces, traditional IR or CEC control must be used to control supported Apple devices.

Specifications

This section provides the following information:

- [AV4 Specifications](#)
- [CP4 Specifications](#)
- [CP4N Specifications](#)
- [CP4-R Specifications](#)
- [DIN-AP4 Specifications](#)
- [DIN-AP4-R Specifications](#)
- [MC4 Specifications](#)
- [MC4-I Specifications](#)
- [MC4-R Specifications](#)
- [MC4-R-I Specifications](#)
- [PRO4 Specifications](#)
- [RMC4 Specifications](#)

NOTE: For PC4-R, VC4, and VC-4-PC-3 specifications, refer to [PC4-R Specifications](#), [VC-4 Specifications](#), and [.VC-4-PC-3 Specifications](#)

AV4 Specifications

Product specifications for the AV4 are provided below.

Product Specifications

Control Engine

Crestron 4-Series™ control processor; real-time, preemptive multithreaded/multitasking kernel; Transaction-Safe Extended FAT file system; supports up to 10 simultaneously-running programs, native .AV Framework™ software program

Ethernet	100/1000 Mbps, autoswitching, autonegotiating, autodiscovery, full/half duplex, industry-standard TCP/IP stack, UDP/IP, CIP, DHCP, SSL, TLS, SSH, SFTP (SSH File Transfer Protocol), FIPS 140-2 compliant encryption, IEEE 802.1X, SNMP, BACnet and IP ² , IPv4 or IPv6, Active Directory® service authentication, HTTPS web server, HTTPS web browser setup and XiO Cloud® client, SMTP email client
Control Subnet	100/1000 Mbps Ethernet, autoswitching, autonegotiating, autodiscovery, full/half duplex, DHCP server, DNS server, port forwarding, isolation mode, IEEE 802.3at Type 1 compliant PoE PSE
Cresnet® Network	Cresnet server mode
USB	Supports USB mass storage class devices via the rear panel USB 2.0 host port, supports computer console via the front panel USB 2.0 device port
RS-232/422/485	For 2-way device control and monitoring, COM port supports RS-232 up to 115.2k baud with software handshaking, one port also supports RS-422 or RS-485 and hardware handshaking
IR/Serial	Supports 1-way device control via infrared up to 1.2 MHz or serial TTL/RS-232 (0–5V) up to 115.2k baud

Memory

SDRAM	2 GB
Flash	8 GB
Memory Card	Supports SD and SDHC cards up to 32 GB
External Storage	Supports USB mass storage devices up to 1 TB

Connectors and Card Slots

S1–S3	(3) Control card expansion slots; Requires CAGE3 accessory (sold separately)
COM 1–2	(2) 5-pin 3.5 mm detachable terminal blocks; Bidirectional RS-232/422/485 ports; Up to 115.2k baud; hardware and software handshaking support
COM 3–6	(4) 3-pin 3.5 mm detachable terminal blocks; Bidirectional RS-232 ports; Up to 115.2k baud; software handshaking support

IR - SERIAL OUTPUT 1-8	(2) 8-pin 3.5 mm detachable terminal blocks; Comprises (8) IR output ports; IR output up to 1.2 MHz; 1-way serial TTL/RS-232 (0-5V) up to 115.2k baud; IRP2 IR emitters sold separately
RELAY OUTPUT 1-8	(2) 8-pin 3.5 mm detachable terminal blocks; Comprises (8) normally open, isolated relays; Rated 1A, 30VAC/VDC; MOV arc suppression across contacts
PoE+ INPUT POWER	(1) Combo D-Sub 7w2 connector, male; 54VDC power input for PoE+ power supply; Enables PoE+ power sourcing on the CONTROL SUBNET ports
CONTROL SUBNET	(4) 8-pin RJ-45 connectors, female; 100BASE-TX/1000BASE-T Ethernet port; PoE+ PSE (Power Sourcing Equipment) port; Provides a dedicated local network for Crestron devices
LAN	(1) 8-pin RJ-45 connector, female; 100BASE-TX/1000BASE-T Ethernet port
USB	(1) USB Type-A connector, female; USB 2.0 port for storage devices
MEMORY	(1) SD memory card slot; Accepts one SD or SDHC card up to 32 GB for storage of log files
I/O 1-8	(1) 9-pin 3.5 mm detachable terminal block; Comprises (8) Versiport digital input/output or analog input ports (referenced to GND); Digital Input: Rated for 0-24VDC, input impedance 20k Ω , logic threshold >3.125V low/0 and <1.875V high/1; Digital Output: 250 mA sink from maximum 24VDC, catch diodes for use with real world loads; Analog Input: Rated for 0-10VDC, protected to 24VDC maximum, input impedance 21k Ω with pull-up resistor disabled; Programmable 5V, 2k Ω pull-up resistor per pin
NET	(1) 4-pin 3.5 mm detachable terminal block; Cresnet server port; Outputs power to Cresnet devices; Alternately functions as a Cresnet power input to power the unit from a Cresnet power supply; See "Power" section below for additional details
100-240V~ 2.4A 50/60Hz	(1) IEC 60320 C14 main power inlet; Mates with removable power cord
G	(1) 6-32 screw; Chassis ground lug
COMPUTER (front)	(1) USB Type-B connector, female; USB 2.0 computer console port; For setup only

Controls and Indicators

PWR	(1) Bicolor green/amber LED, indicates operating power is present; Amber indicates that the device is booting and is not yet ready to operate; Green indicates that the device is ready to operate
NET	(1) Amber LED, indicates communication with Cresnet devices
MSG	(1) Red LED, indicates control processor has generated a logging message
HW-R	(1) Recessed push button, initiates a hardware reset
SW-R	(1) Recessed push button, initiates a software reset
CNPS FAULT	(1) Red LED and (1) push button; LED indicates an excessive Cresnet load is detected at the NET port; Push button resets the fault indication
SLOT 1-3	(3) Green LEDs, indicates control cards are present in the corresponding rear panel slots
LAN (rear)	(1) Bicolor green/amber and (1) amber LEDs; Green/amber LED indicates Ethernet link status and connection speed; Amber LED indicates Ethernet activity
CONTROL SUBNET (rear)	(1) Bicolor green/amber and (1) amber LEDs; Green/amber LED indicates Ethernet link status and connection speed; Amber LED indicates Ethernet activity

Power

Main Power	2.4A @ 100–240VAC, 50/60Hz
Power over Ethernet Plus (PoE+)	IEEE 802.3at compliant PoE+ PSE (Power Sourcing Equipment); 120 W total power; Each CONTROL SUBNET port supplies up to 30 W to power one PoE+ (Class 4) PD (Powered Device)
Available Cresnet Power	75 W (3.125A @ 24VDC)

Environmental

Temperature	41 to 104°F (5 to 40°C)
Humidity	10% to 90% RH (noncondensing)
Heat Dissipation	43 BTU/hr

Enclosure

Chassis	Steel, vented sides and top
Front Panel	Extruded metal, black finish, polycarbonate label overlay
Faceplate	Extruded metal, black finish, polycarbonate label overlay
Mounting	Freestanding or 2 RU 19-in. rack mountable (adhesive feet and rack ears included)

Dimensions

Height	3.47 in. (89 mm) without feet
---------------	-------------------------------

Width	17.28 in. (439 mm); 19.00 in. (483 mm) with rack ears
Depth	10.11 in. (257 mm)

Weight

10.4 lb (4.70 kg)

Compliance

Regulatory Model: M201903001;

BV Listed for US & Canada, CE, IC, FCC Part 15 Class B digital device

To search for product certificates, refer to support.crestron.com/app/certificates.

Dimension Drawings

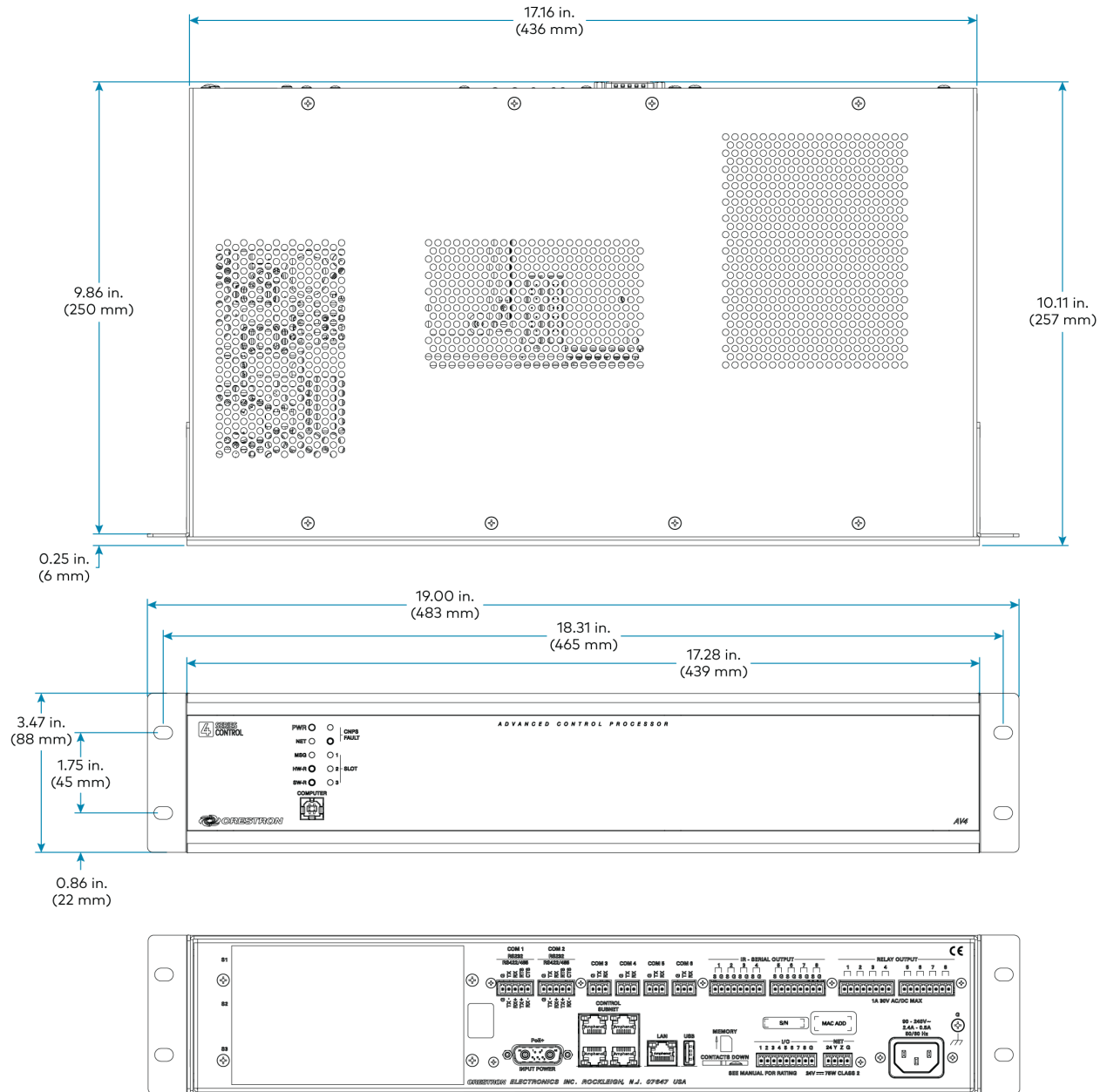

Notes:

1. The following connections comply with IEC 61000-4-5 Installation Class 4 surge immunity levels: COM 1–6, I/O 1–8, NET, LAN, and CONTROL SUBNET.
2. A BACnet and IP license is required. A free license is available to support up to 50 BACnet objects on a single 4-Series control system. Support for more than 50 BACnet objects requires the purchase of one [SW-3SERIES-BACNET-50+](#) license. The AV4 supports a maximum of 2000 BACnet objects when dedicated for BACnet use only. Actual capabilities are contingent upon the overall program size and complexity. To obtain the license, visit www.crestron.com/bacnetlicense.
3. This feature is only available when using the TSR-310. Other Crestron touch screens, handheld remotes, and keypads are not supported. For these interfaces, traditional IR or CEC control must be used to control supported Apple devices.

CP4 Specifications

Product specifications for the CP4 are provided below.

Product Specifications

Control Engine

Crestron 4-Series™ control processor; real-time, preemptive multithreaded/multitasking kernel; Transaction-Safe Extended FAT file system; supports up to 10 simultaneously-running programs, native .AV Framework™ software program

Ethernet	100/1000 Mbps, autoswitching, autonegotiating, autodiscovery, full/half duplex, industry-standard TCP/IP stack, UDP/IP, CIP, DHCP, SSL, TLS, SSH, SFTP (SSH File Transfer Protocol), FIPS 140-2 compliant encryption, IEEE 802.1X, SNMP, BACnet and IP ¹ , IPv4 or IPv6, Active Directory® service authentication, HTTPS web server, HTTPS web browser setup and XiO Cloud® client, SMTP email client
Cresnet® Network	Cresnet server mode
USB	Supports USB mass storage class devices via the rear panel USB 2.0 host port, supports computer console via the front panel USB 2.0 device port
RS-232/422/485	For 2-way device control and monitoring, COM port supports RS-232 up to 115.2k baud with software handshaking, one port also supports RS-422 or RS-485 and hardware handshaking
IR/Serial	Supports 1-way device control via infrared up to 1.2 MHz or serial TTL/RS-232 (0–5V) up to 115.2k baud

Memory

SDRAM	2 GB
Flash	8 GB
Memory Card	Supports SD and SDHC cards up to 32 GB
External Storage	Supports USB mass storage devices up to 1 TB

Connectors and Card Slots

RELAY OUTPUT 1–8	(2) 8-pin 3.5 mm detachable terminal blocks; Comprises (8) normally open, isolated relays; Rated 1A, 30VAC/VDC; MOV arc suppression across contacts
-----------------------------	--

I/O 1–8	<p>(1) 9-pin 3.5 mm detachable terminal block; Comprises (8) Versiport digital input/output or analog input ports (referenced to GND); Digital Input: Rated for 0–24VDC, input impedance 20k Ω, logic threshold >3.125V low/0 and <1.875V high/1; Digital Output: 250 mA sink from maximum 24VDC, catch diodes for use with real world loads; Analog Input: Rated for 0–10VDC, protected to 24VDC maximum, input impedance 21k Ω with pull-up resistor disabled; Programmable 5V, 2k Ω pull-up resistor per pin</p>
IR - SERIAL OUTPUT 1–8	<p>(2) 8-pin 3.5 mm detachable terminal blocks; Comprises (8) IR output ports; IR output up to 1.2 MHz; 1-way serial TTL/RS-232 (0–5V) up to 115.2k baud; IRP2 IR emitters sold separately</p>
COM 1	<p>(1) 5-pin 3.5 mm detachable terminal block; Bidirectional RS-232/422/485 port; Up to 115.2k baud; hardware and software handshaking support</p>
COM 2–3	<p>(2) 3-pin 3.5 mm detachable terminal blocks; Bidirectional RS-232 ports; Up to 115.2k baud; software handshaking support</p>
MEMORY	<p>(1) SD memory card slot; Accepts one SD or SDHC card up to 32 GB for storage of log files</p>
USB	<p>(1) USB Type-A connector, female; USB 2.0 port for storage devices</p>
LAN	<p>(1) 8-pin RJ-45 connector, female; 100BASE-TX/1000BASE-T Ethernet port;</p>
NET	<p>(1) 4-pin 3.5 mm detachable terminal block; Cresnet server port; Outputs power to Cresnet devices only if the included power pack is connected to the 24VDC power input jack; Alternately functions as a Cresnet power input to power the unit from a Cresnet power supply; See "Power" section for additional details</p>
24VDC 2.0A	<p>(1) 2.1 x 5.5 mm DC power connector; 24VDC power input; PW-2420RU power pack included; Passes through to the NET port to power Cresnet devices; See "Power" section for additional details</p>
G	<p>(1) 6-32 screw; Chassis ground lug</p>
COMPUTER (front)	<p>(1) USB Type-B connector, female; USB 2.0 computer console port; For setup only</p>

Controls and Indicators

PWR	(1) Bicolor green/amber LED, indicates operating power is present; Amber indicates that the device is booting and is not yet ready to operate; Green indicates that the device is ready to operate
NET	(1) Amber LED, indicates communication with Cresnet devices
MSG	(1) Red LED, indicates control processor has generated a logging message
HW-R	(1) Recessed push button, initiates a hardware reset
SW-R	(1) Recessed push button, initiates a software reset
LAN (rear)	(1) Bicolor green/amber and (1) amber LEDs; Green/amber LED indicates Ethernet link status and connection speed; Amber LED indicates Ethernet activity

Power

Power Source Options	Power pack or Cresnet (connect only one)
Power Pack (included)	Input: 100–240VAC, 50/60 Hz; Output: 2.5A @ 24VDC; Model: PW-2420RU
Cresnet Power Usage	15 W (0.625A @ 24VDC) when powered by a Cresnet power supply only
Available Cresnet Power	24 W (1A @ 24VDC) when powered by the included power pack only
Power Consumption	15 W (not including any connected Cresnet devices)

Environmental

Temperature	41 to 113°F (5 to 45°C)
Humidity	10% to 90% RH (noncondensing)
Heat Dissipation	50 BTU/hr

Enclosure

Chassis	Steel, vented sides
Front Panel	Extruded metal, black finish, polycarbonate label overlay
Faceplate	Extruded metal, black finish, polycarbonate label overlay
Mounting	Freestanding or 1 RU 19-in. rack mountable (adhesive feet and rack ears included)

Dimensions

Height	1.70 in. (44 mm) without feet
Width	17.28 in. (439 mm); 19.00 in. (483 mm) with rack ears
Depth	6.56 in. (167 mm)

Weight

4.3 lb (1.94 kg)

Compliance

Regulatory Model: M201903001;

UL® Listed for US & Canada, CE, IC, FCC Part 15 Class B digital device

To search for product certificates, refer to support.crestron.com/app/certificates.

Dimension Drawings

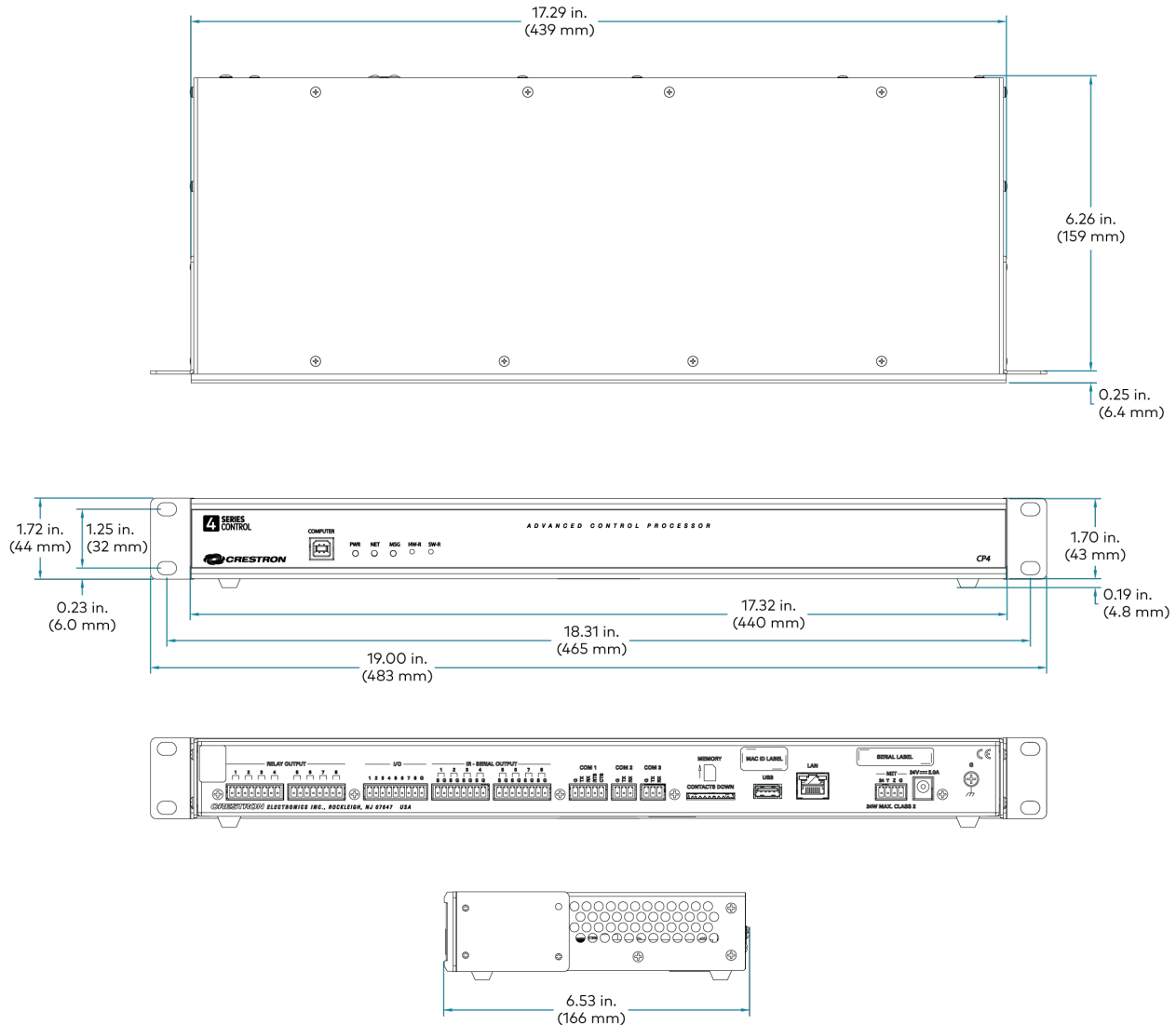

Notes:

1. A BACnet and IP license is required. A free license is available to support up to 50 BACnet objects on a single 4-Series control system. Support for more than 50 BACnet objects requires the purchase of one [SW-3SERIES-BACNET-50+](http://www.crestron.com/bacnetlicense) license. The CP4 supports a maximum of 1000 BACnet objects when dedicated for BACnet use only. Actual capabilities are contingent upon the overall program size and complexity. To obtain the license, visit www.crestron.com/bacnetlicense.
2. This feature is only available when using the TSR-310. Other Crestron touch screens, handheld remotes, and keypads are not supported. For these interfaces, traditional IR or CEC control must be used to control supported Apple devices.

CP4N Specifications

Product specifications for the CP4N are provided below.

Product Specifications

Control Engine

Crestron 4-Series™ control processor; real-time, preemptive multithreaded/multitasking kernel; Transaction-Safe Extended FAT file system; supports up to 10 simultaneously-running programs, native .AV Framework™ software program

Ethernet	100/1000 Mbps, autoswitching, autonegotiating, autodiscovery, full/half duplex, industry-standard TCP/IP stack, UDP/IP, CIP, DHCP, SSL, TLS, SSH, SFTP (SSH File Transfer Protocol), FIPS 140-2 compliant encryption, IEEE 802.1X, SNMP, BACnet and IP ¹ , IPv4 or IPv6, Active Directory® service authentication, HTTPS web server, HTTPS web browser setup and XiO Cloud® client, SMTP email client
Control Subnet	100/1000 Mbps Ethernet, autoswitching, autonegotiating, autodiscovery, full/half duplex, DHCP server, DNS server, port forwarding, isolation mode
Cresnet® Network	Cresnet server mode
USB	Supports USB mass storage class devices via the rear panel USB 2.0 host port, supports computer console via the front panel USB 2.0 device port
RS-232/422/485	For 2-way device control and monitoring, COM port supports RS-232 up to 115.2k baud with software handshaking, one port also supports RS-422 or RS-485 and hardware handshaking
IR/Serial	Supports 1-way device control via infrared up to 1.2 MHz or serial TTL/RS-232 (0–5V) up to 115.2k baud

Memory

SDRAM	2 GB
Flash	8 GB
Memory Card	Supports SD and SDHC cards up to 32 GB
External Storage	Supports USB mass storage devices up to 1 TB

Connectors and Card Slots

RELAY OUTPUT 1–8	(2) 8-pin 3.5 mm detachable terminal blocks; Comprises (8) normally open, isolated relays; Rated 1A, 30VAC/VDC; MOV arc suppression across contacts
-----------------------------	--

I/O 1–8	<p>(1) 9-pin 3.5 mm detachable terminal block; Comprises (8) Versiport digital input/output or analog input ports (referenced to GND); Digital Input: Rated for 0–24VDC, input impedance 20k Ω, logic threshold >3.125V low/0 and <1.875V high/1; Digital Output: 250 mA sink from maximum 24VDC, catch diodes for use with real world loads; Analog Input: Rated for 0–10VDC, protected to 24VDC maximum, input impedance 21k Ω with pull-up resistor disabled; Programmable 5V, 2k Ω pull-up resistor per pin</p>
IR - SERIAL OUTPUT 1–8	<p>(2) 8-pin 3.5 mm detachable terminal blocks; Comprises (8) IR output ports; IR output up to 1.2 MHz; 1-way serial TTL/RS-232 (0–5V) up to 115.2k baud; IRP2 IR emitters sold separately</p>
COM 1	<p>(1) 5-pin 3.5 mm detachable terminal block; Bidirectional RS-232/422/485 port; Up to 115.2k baud; hardware and software handshaking support</p>
COM 2–3	<p>(2) 3-pin 3.5 mm detachable terminal blocks; Bidirectional RS-232 ports; Up to 115.2k baud; software handshaking support</p>
MEMORY	<p>(1) SD memory card slot; Accepts one SD or SDHC card up to 32 GB for storage of log files</p>
USB	<p>(1) USB Type-A connector, female; USB 2.0 port for storage devices</p>
LAN	<p>(1) 8-pin RJ-45 connector, female; 100BASE-TX/1000BASE-T Ethernet port;</p>
CONTROL SUBNET	<p>(1) 8-pin RJ-45 connector, female; 100BASE-TX/1000BASE-T Ethernet port; Provides a dedicated local network for Crestron devices</p>
NET	<p>(1) 4-pin 3.5 mm detachable terminal block; Cresnet server port; Outputs power to Cresnet devices only if the included power pack is connected to the 24VDC power input jack; Alternately functions as a Cresnet power input to power the unit from a Cresnet power supply; See "Power" section for additional details</p>
24VDC 2.0A	<p>(1) 2.1 x 5.5 mm DC power connector; 24VDC power input; PW-2420RU power pack included; Passes through to the NET port to power Cresnet devices; See "Power" section for additional details</p>
G	<p>(1) 6-32 screw; Chassis ground lug</p>

COMPUTER (front)	(1) USB Type-B connector, female; USB 2.0 computer console port; For setup only
-------------------------	---

Controls and Indicators

PWR	(1) Bicolor green/amber LED, indicates operating power is present; Amber indicates that the device is booting and is not yet ready to operate; Green indicates that the device is ready to operate
NET	(1) Amber LED, indicates communication with Cresnet devices
MSG	(1) Red LED, indicates control processor has generated a logging message
HW-R	(1) Recessed push button, initiates a hardware reset
SW-R	(1) Recessed push button, initiates a software reset
LAN (rear)	(1) Bicolor green/amber and (1) amber LEDs; Green/amber LED indicates Ethernet link status and connection speed; Amber LED indicates Ethernet activity
CONTROL SUBNET (rear)	(1) Bicolor green/amber and (1) amber LEDs; Green/amber LED indicates Ethernet link status and connection speed; Amber LED indicates Ethernet activity

Power

Power Source Options	Power pack or Cresnet (connect only one)
Power Pack (included)	Input: 100–240VAC, 50/60 Hz; Output: 2.5A @ 24VDC; Model: PW-2420RU
Cresnet Power Usage	15 W (0.625A @ 24VDC) when powered by a Cresnet power supply only
Available Cresnet Power	24 W (1A @ 24VDC) when powered by the included power pack only
Power Consumption	15 W (not including any connected Cresnet devices)

Environmental

Temperature	41 to 113°F (5 to 45°C)
Humidity	10% to 90% RH (noncondensing)
Heat Dissipation	50 BTU/hr

Enclosure

Chassis	Steel, vented sides
Front Panel	Extruded metal, black finish, polycarbonate label overlay
Faceplate	Extruded metal, black finish, polycarbonate label overlay
Mounting	Freestanding or 1 RU 19-in. rack mountable (adhesive feet and rack ears included)

Dimensions

Height	1.70 in. (44 mm) without feet
---------------	-------------------------------

Width 17.28 in. (439 mm);
19.00 in. (483 mm) with rack ears

Depth 6.56 in. (167 mm)

Weight

4.6 lb (2.06 kg)

Compliance

Regulatory Model: M201903001;

UL® Listed for US & Canada, CE, IC, FCC Part 15 Class B digital device

To search for product certificates, refer to support.crestron.com/app/certificates.

Dimension Drawings

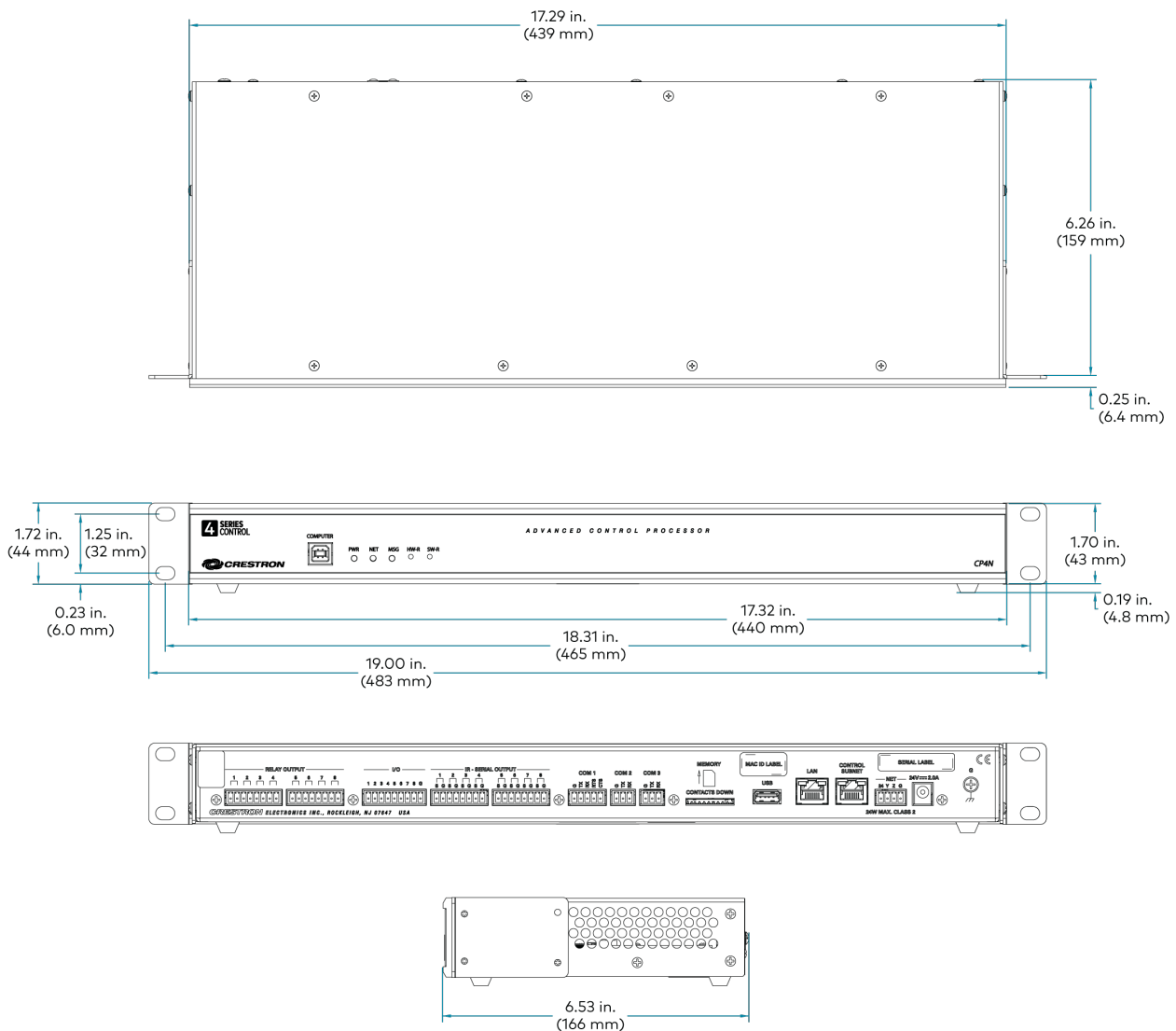

Notes:

1. A BACnet and IP license is required. A free license is available to support up to 50 BACnet objects on a single 4-Series control system. Support for more than 50 BACnet objects requires the purchase of one [SW-3SERIES-BACNET-50+](#) license. The CP4N supports a maximum of 1000 BACnet objects when dedicated for BACnet use only. Actual capabilities are contingent upon the overall program size and complexity. To obtain the license, visit www.crestron.com/bacnetlicense.
2. This feature is only available when using the TSR-310. Other Crestron touch screens, handheld remotes, and keypads are not supported. For these interfaces, traditional IR or CEC control must be used to control supported Apple devices.

CP4-R Specifications

Product specifications for the CP4-R are provided below.

Product Specifications

Ethernet	100/1000 Mbps, autoswitching, autonegotiating, autodiscovery, full/half duplex, industry-standard TCP/IP stack, UDP/IP, CIP, DHCP, SSL, TLS, SSH, SFTP (SSH File Transfer Protocol), FIPS 140-2 compliant encryption, IPv4 or IPv6, HTTPS web server, SMTP email client
Cresnet® Network	Cresnet server mode ³
USB	Supports USB mass storage class devices via the rear panel USB 2.0 host port, supports computer console via the front panel USB 2.0 device port
RS-232/422/485	For 2-way device control and monitoring, COM port supports RS-232 up to 115.2k baud with software handshaking, one port also supports RS-422 or RS-485 and hardware handshaking
IR/Serial	Supports 1-way device control via infrared up to 1.2 MHz or serial TTL/RS-232 (0–5V) up to 115.2k baud

Memory

SDRAM	4 GB
Flash	8 GB
Memory Card	Supports SD and SDHC cards up to 32 GB (4 GB SDHC card included)
External Storage	Supports USB mass storage devices up to 1 TB

Connectors and Card Slots

RELAY OUTPUT 1–8	(2) 8-pin 3.5 mm detachable terminal blocks; Comprises (8) normally open, isolated relays; Rated 1A, 30VAC/VDC; MOV arc suppression across contacts
I/O 1–8	(1) 9-pin 3.5 mm detachable terminal block; Comprises (8) Versiport digital input/output or analog input ports (referenced to GND); Digital Input: Rated for 0–24VDC, input impedance 20k Ω , logic threshold >3.125V low/0 and <1.875V high/1; Digital Output: 250 mA sink from maximum 24VDC, catch diodes for use with real world loads; Analog Input: Rated for 0–10VDC, protected to 24VDC maximum, input impedance 21k Ω with pull-up resistor disabled; Programmable 5V, 2k Ω pull-up resistor per pin

IR - SERIAL OUTPUT 1–8	(2) 8-pin 3.5 mm detachable terminal blocks; Comprises (8) IR output ports; IR output up to 1.2 MHz; 1-way serial TTL/RS-232 (0–5V) up to 115.2k baud; IRP2 IR emitters sold separately
COM 1	(1) 5-pin 3.5 mm detachable terminal block; Bidirectional RS-232/422/485 port; Up to 115.2k baud; hardware and software handshaking support
COM 2–3	(2) 3-pin 3.5 mm detachable terminal blocks; Bidirectional RS-232 ports; Up to 115.2k baud; software handshaking support
MEMORY	(1) SD memory card slot; Accepts one SD or SDHC card up to 32 GB for storage of log files 4 GB SDHC card included
USB	(1) USB Type-A connector, female; USB 2.0 port for storage devices
LAN	(1) 8-pin RJ-45 connector, female; 100BASE-TX/1000BASE-T Ethernet port;
NET	(1) 4-pin 3.5 mm detachable terminal block; Cresnet server port; Outputs power to Cresnet devices only if the included power pack is connected to the 24VDC power input jack; Alternately functions as a Cresnet power input to power the unit from a Cresnet power supply; See "Power" section for additional details
24VDC 2.0A	(1) 2.1 x 5.5 mm DC power connector; 24VDC power input; PW-2420RU power pack included; Passes through to the NET port to power Cresnet devices; See "Power" section for additional details
G	(1) 6-32 screw; Chassis ground lug
COMPUTER (front)	(1) USB Type-B connector, female; USB 2.0 computer console port; For setup only

Controls and Indicators

PWR	(1) Bicolor green/amber LED, indicates operating power is present; Amber indicates that the device is booting and is not yet ready to operate; Green indicates that the device is ready to operate
NET	(1) Amber LED, indicates communication with Cresnet devices
MSG	(1) Red LED, indicates control processor has generated a logging message
HW-R	(1) Recessed push button, initiates a hardware reset
SW-R	(1) Recessed push button, initiates a software reset

LAN (rear) (1) Bicolor green/amber and (1) amber LEDs;
Green/amber LED indicates Ethernet link status and connection speed;
Amber LED indicates Ethernet activity

Power

Power Source Options Power pack or Cresnet (connect only one)

Power Pack (included) Input: 100–240VAC, 50/60 Hz;
Output: 2.5A @ 24VDC;
Model: PW-2420RU

Cresnet Power Usage 15 W (0.625A @ 24VDC) when powered by a Cresnet power supply only

Available Cresnet Power 24 W (1A @ 24VDC) when powered by the included power pack only

Power Consumption 15 W (not including any connected Cresnet devices)

Environmental

Temperature 41 to 113°F (5 to 45°C)

Humidity 10% to 90% RH (noncondensing)

Heat Dissipation 50 BTU/hr

Enclosure

Chassis Steel, vented sides

Front Panel Extruded metal, black finish, polycarbonate label overlay

Mounting Freestanding or 1 RU 19-in. rack mountable (adhesive feet and rack ears included)

Dimensions

Height 1.70 in. (44 mm) without feet

Width 17.28 in. (439 mm);
19.00 in. (483 mm) with rack ears

Depth 6.56 in. (167 mm)

Weight

3.1 lb (1.42 kg)

Compliance

Regulatory Model: M201903001;
UL® Listed for US & Canada, CE, IC, FCC Part 15 Class B digital device

To search for product certificates, refer to support.crestron.com/app/certificates.

Dimension Drawings

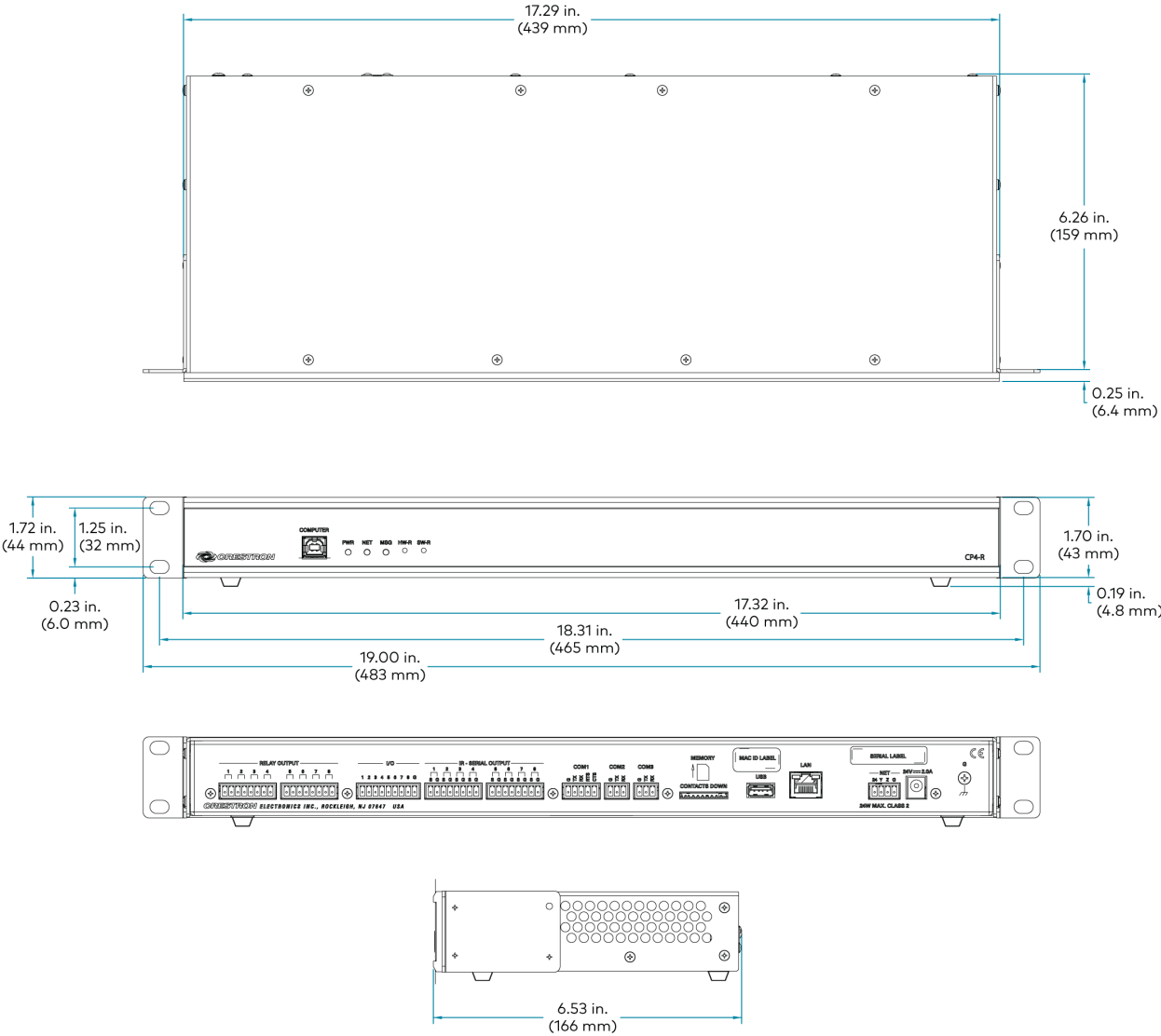

Notes:

1. Up to 2000 BACnet objects are supported out of the box with no licensing required.
2. Support for infiNET EX® network wireless devices is enabled by adding an infiNET EX wireless gateway ([CEN-GWEXER](#) or [CENI-GWEXER](#) sold separately).
3. The Cresnet™ port (NET) is strictly for use with specific Crestron® devices that work with Crestron Home® OS. In addition to Cresnet or Ethernet, many Crestron wireless devices are also supported by adding an infiNET EX wireless gateway. For a list of Crestron Home compatible devices, please visit: www.crestron.com/crestronhome.

DIN-AP4 Specifications

Product specifications for the DIN-AP4 are provided below.

Product Specifications

Control Engine

Crestron 4-Series™ control processor; real-time, preemptive multithreaded/multitasking kernel; Transaction-Safe Extended FAT file system; supports up to 10 simultaneously-running programs, native .AV Framework™ software program

Ethernet	100 Mbps, autoswitching, autonegotiating, autodiscovery, full/half duplex, industry-standard TCP/IP stack, UDP/IP, CIP, DHCP, SSL, TLS, SSH, SFTP (SSH File Transfer Protocol), FIPS 140-2 compliant encryption, IEEE 802.1X, SNMP, BACnet and IP ¹ , IPv4 or IPv6, Active Directory® service authentication, HTTPS web server, HTTPS web browser setup and XiO Cloud® client, SMTP email client
Cresnet® Network	Cresnet server mode
USB	Supports USB mass storage class devices via the front panel USB 2.0 host port, supports computer console via the front panel USB 2.0 device port
RS-232/422/485	For 2-way device control and monitoring, COM port supports RS-232 up to 115.2k baud with software handshaking, one port also supports RS-422 or RS-485 and hardware handshaking
IR/Serial	Supports 1-way device control via infrared up to 1.2 MHz or serial TTL/RS-232 (0–5V) up to 115.2k baud

Memory

DDR3 SDRAM	1 GB
Flash	8 GB
Memory Card	Supports SD and SDHC cards up to 32 GB
External Storage	Supports USB mass storage devices up to 1 TB

Connectors and Card Slots

I/O 1–8	(1) 9-pin 3.5 mm detachable terminal block; Comprises (8) Versiport digital input/output or analog input ports (referenced to GND); Digital Input: Rated for 0–24VDC, input impedance 20k Ω , logic threshold >3.125V low/0 and <1.875V high/1; Digital Output: 250 mA sink from maximum 24VDC, catch diodes for use with real world loads; Analog Input: Rated for 0–10VDC, protected to 24VDC maximum, input impedance 21k Ω with pull-up resistor disabled; Programmable 5V, 2k Ω pull-up resistor per pin
MEMORY	(1) SD memory card slot; Accepts one SD or SDHC card up to 32 GB for storage of log files

IR/SERIAL 1–4	(1) 8-pin 3.5 mm detachable terminal block; Comprises (4) IR output ports; IR output up to 1.2 MHz; 1-way serial TTL/RS-232 (0–5V) up to 115.2k baud; IRP2 IR emitters sold separately
RELAYS 1–4	(1) 8-pin 3.5 mm detachable terminal block; Comprises (4) normally open, isolated relays; Rated 1A, 30VAC/VDC; MOV arc suppression across contacts
COMPUTER	(1) USB Type-B connector, female; USB 2.0 computer console port; For setup only
PWR	(1) 2-pin 3.5 mm detachable terminal block; 24VDC power input for power supply (sold separately)
NET	(2) 4-pin 3.5 mm detachable terminal blocks, paralleled; Cresnet server port
COM 1–2	(2) 5-pin 3.5 mm detachable terminal blocks; Bidirectional RS-232/422/485 ports; Up to 115.2k baud; hardware and software handshaking support
G	(1) 6-32 screw; Chassis ground lug
USB	(1) USB Type-A connector, female; USB 2.0 port for storage devices
LAN PoE	(1) 8-pin RJ-45 connector, female; 100BASE-TX/1000BASE-T Ethernet port; PoE (Power over Ethernet) PD (Powered Device) port

Controls and Indicators

PWR	(1) Bicolor green/amber LED, indicates operating power is present; Amber indicates that the device is booting and is not yet ready to operate; Green indicates that the device is ready to operate
NET	(1) Amber LED, indicates communication with Cresnet devices
MSG	(1) Red LED, indicates control processor has generated a logging message
HW-R	(1) Recessed miniature push button, initiates a hardware reset
SW-R	(1) Recessed miniature push button, initiates a software reset
LAN	(1) Bicolor green/amber and (1) amber LEDs; Green/amber LED indicates Ethernet link status and connection speed; Amber LED indicates Ethernet activity

Power

Power Source Options	Power supply (sold separately) or Power over Ethernet (PoE)
Power Supply	Must supply 24VDC to 2-pin terminal block via flying leads; Use model DIN-PWS30-277 or equivalent

Power over Ethernet (PoE)	IEEE 802.3at Type 1 (802.3af compatible) Class 0 (12.95 W) PoE Powered Device
Available Cresnet Power	2.5 W maximum via PoE; 20 W maximum when powered via DIN-PWS30-277
Power Consumption	9.7 W (not including any connected Cresnet devices)

Environmental

Temperature	41 to 113°F (5 to 45°C)
Humidity	10% to 90% RH (noncondensing)
Heat Dissipation	33 BTU/hr

Enclosure

Housing	Light gray polycarbonate housing with polycarbonate label overlay, UL94 V-0 rated
Mounting	35 mm DIN EN 60715 rail mount; DIN 43880 form factor for enclosures with 45 mm front panel cutout; Occupies 9 DIN module spaces (162 mm)

Dimensions

Height	3.57 in. (91 mm)
Width	6.33 in. (161 mm)
Depth	2.28 in. (58 mm)

Weight

1.1 lb (0.50 kg)

Compliance

Regulatory Model: DIN-AP4;

UL® Listed for US & Canada, CE, IC, FCC Part 15 Class B digital device

To search for product certificates, refer to support.crestron.com/app/certificates.

Dimension Drawings

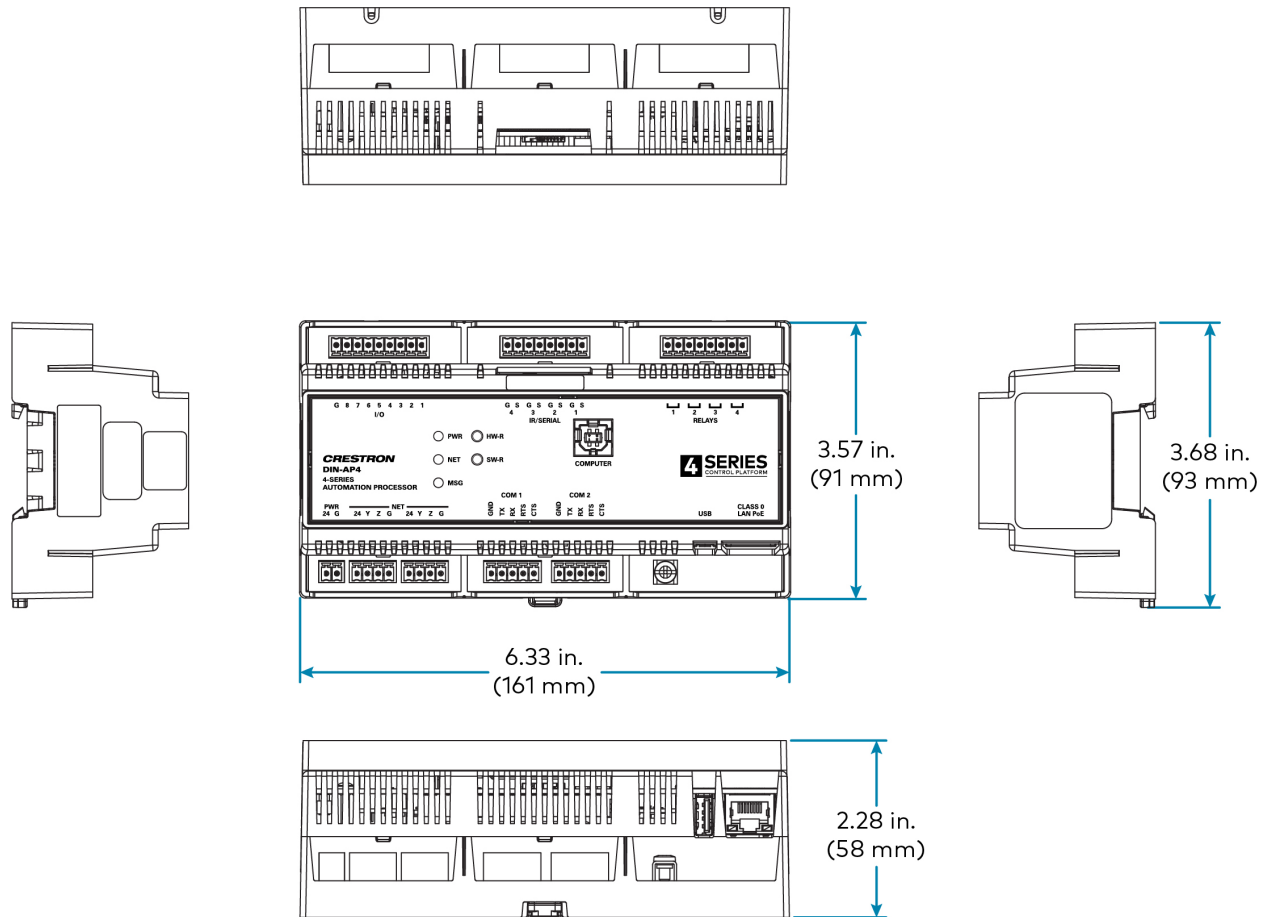

Notes:

1. A BACnet and IP license is required. A free license is available to support up to 50 BACnet objects on a single 4-Series control system. Support for more than 50 BACnet objects requires the purchase of one [SW-3SERIES-BACNET-50+](#) license. The DIN-AP4 supports a maximum of 500 BACnet objects when dedicated for BACnet use only. Actual capabilities are contingent upon the overall program size and complexity. To obtain the license, visit www.crestron.com/bacnetlicense.
2. This feature is only available when using the TSR-310. Other Crestron touch screens, handheld remotes, and keypads are not supported. For these interfaces, traditional IR or CEC control must be used to control supported Apple devices.

DIN-AP4-R Specifications

Product specifications for the DIN-AP4-R are provided below.

Product Specifications

Ethernet	100/1000 Mbps, autoswitching, autonegotiating, autodiscovery, full/half duplex, industry-standard TCP/IP stack, UDP/IP, CIP, DHCP, SSL, TLS, SSH, SFTP (SSH File Transfer Protocol), FIPS 140-2 compliant encryption ¹ , IPv4 or IPv6, HTTPS web server, SMTP email client
Cresnet® Network	Cresnet server mode ³
USB	Supports USB mass storage class devices via the front panel USB 2.0 host port, supports computer console via the front panel USB 2.0 device port
RS-232/422/485	For 2-way device control and monitoring, COM port supports RS-232 up to 115.2k baud with software handshaking, one port also supports RS-422 or RS-485 and hardware handshaking
IR/Serial	Supports 1-way device control via infrared up to 1.2 MHz or serial TTL/RS-232 (0–5V) up to 115.2k baud
BACnet™ network/IP	Supports up to 500 BACnet objects ¹

Memory

SDRAM	2 GB
Flash	8 GB
Memory Card	Supports microSD® cards up to 32 GB (4 GB microSD card included)
External Storage	Supports USB mass storage devices up to 1 TB

Connectors and Card Slots

I/O 1–8	(1) 9-pin 3.5 mm detachable terminal block; Comprises (8) Versiport digital input/output or analog input ports (referenced to GND); Digital Input: Rated for 0–24VDC, input impedance 20k Ω , logic threshold >3.125V low/0 and <1.875V high/1; Digital Output: 250 mA sink from maximum 24VDC, catch diodes for use with real world loads; Analog Input: Rated for 0–10VDC, protected to 24VDC maximum, input impedance 21k Ω with pull-up resistor disabled; Programmable 5V, 2k Ω pull-up resistor per pin
MEMORY	(1) microSD memory card slot; Accepts one microSD card up to 32 GB for storage of log files 4 GB microSD card included

IR/SERIAL 1–4	(1) 8-pin 3.5 mm detachable terminal block; Comprises (4) IR output ports; IR output up to 1.2 MHz; 1-way serial TTL/RS-232 (0–5V) up to 115.2k baud; IRP2 IR emitters sold separately
RELAYS 1–4	(1) 8-pin 3.5 mm detachable terminal block; Comprises (4) normally open, isolated relays; Rated 1A, 30VAC/VDC; MOV arc suppression across contacts
COMPUTER	(1) USB Type-B connector, female; USB 2.0 computer console port; For setup only
PWR	(1) 2-pin 3.5 mm detachable terminal block; 24VDC power input for power supply (sold separately)
NET	(2) 4-pin 3.5 mm detachable terminal blocks, paralleled; Cresnet server port
COM 1–2	(2) 5-pin 3.5 mm detachable terminal blocks; Bidirectional RS-232/422/485 ports; Up to 115.2k baud; hardware and software handshaking support
G	(1) 6-32 screw; Chassis ground lug
USB	(1) USB Type-A connector, female; USB 2.0 port for storage devices
LAN PoE	(1) 8-pin RJ-45 connector, female; 100BASE-TX/1000BASE-T Ethernet port; PoE (Power over Ethernet) PD (Powered Device) port

Controls and Indicators

PWR	(1) Bicolor green/amber LED, indicates operating power is present; Amber indicates that the device is booting and is not yet ready to operate; Green indicates that the device is ready to operate
NET	(1) Amber LED, indicates communication with Cresnet devices
MSG	(1) Red LED, indicates control processor has generated a logging message
HW-R	(1) Recessed miniature push button, initiates a hardware reset
SW-R	(1) Recessed miniature push button, initiates a software reset
LAN	(1) Bicolor green/amber and (1) amber LEDs; Green/amber LED indicates Ethernet link status and connection speed; Amber LED indicates Ethernet activity

Power

Power Source Options	Power supply (sold separately) or Power over Ethernet (PoE)
Power Supply	Must supply 24VDC to 2-pin terminal block via flying leads; Use model DIN-PWS30-277 or equivalent

Power over Ethernet (PoE)	IEEE 802.3at Type 1 (802.3af compatible) Class 0 (12.95 W) PoE Powered Device
Available Cresnet Power	2.5 W maximum via PoE; 20 W maximum when powered via DIN-PWS30-277
Power Consumption	9.7 W (not including any connected Cresnet devices)

Environmental

Temperature	41 to 113°F (5 to 45°C)
Humidity	10% to 90% RH (noncondensing)
Heat Dissipation	33 BTU/hr

Enclosure

Housing	Light gray polycarbonate housing with polycarbonate label overlay, UL94 V-0 rated
Mounting	35 mm DIN EN 60715 rail mount; DIN 43880 form factor for enclosures with 45 mm front panel cutout; Occupies 9 DIN module spaces (162 mm)

Dimensions

Height	3.57 in. (91 mm)
Width	6.33 in. (161 mm)
Depth	2.28 in. (58 mm)

Weight

9.8 oz (277 g)

Compliance

Regulatory Model: DIN-AP4;

UL® Listed for US & Canada, CE, IC, FCC Part 15 Class B digital device

To search for product certificates, refer to support.crestron.com/app/certificates.

Dimension Drawings

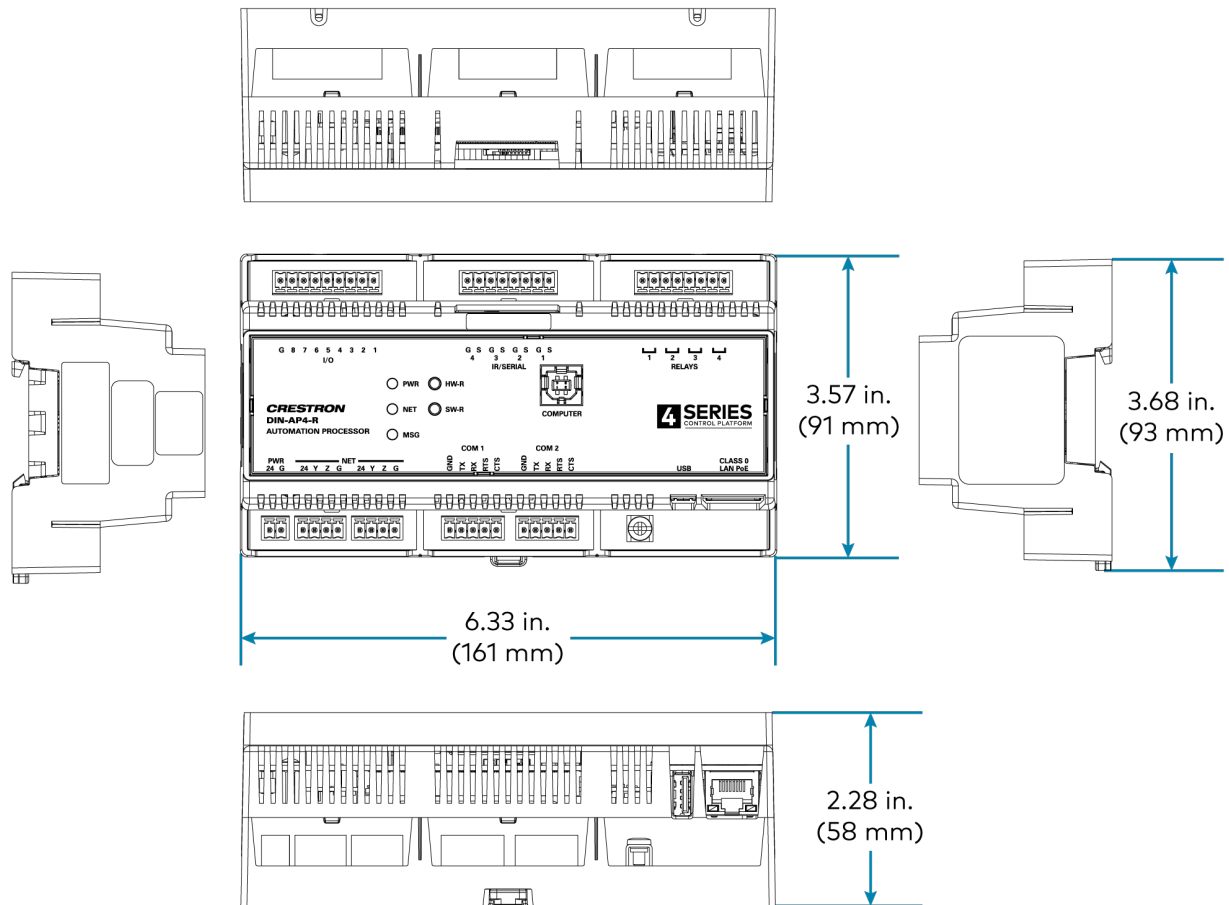

Notes:

1. Up to 500 BACnet objects are supported out of the box with no licensing required.
2. Support for infiNET EX® network wireless devices is enabled by adding an infiNET EX wireless gateway ([CEN-GWEXER](#) or [CENI-GWEXER](#) sold separately).
3. The Cresnet™ port (NET) is strictly for use with specific Crestron® devices that work with Crestron Home® OS. In addition to Cresnet or Ethernet, many Crestron wireless devices are also supported by adding an infiNET EX wireless gateway. For a list of Crestron Home compatible devices, please visit: www.crestron.com/crestronhome.

MC4 Specifications

Product specifications for the MC4 are provided below.

Product Specifications

Control Engine

Crestron 4-Series™ control processor; real-time, preemptive multithreaded/multitasking kernel; Transaction-Safe Extended FAT file system; supports up to 10 simultaneously-running programs (license required¹), native .AV Framework™ software program

Wired Communications

Ethernet	100/1000 Mbps, autoswitching, autonegotiating, autodiscovery, full/half duplex, industry-standard TCP/IP stack, UDP/IP, CIP, DHCP, SSL, TLS, SSH, SFTP (SSH File Transfer Protocol), FIPS 140-2 compliant encryption, IEEE 802.1X, SNMP, BACnet and IP ³ , IPv4 or IPv6, Active Directory® service authentication, HTTPS web server, HTTPS web browser setup and XiO Cloud® client, SMTP email client
Cresnet® Network	Cresnet server mode
USB	Supports USB mass storage class devices via the rear panel USB 2.0 host port
RS-232	For 2-way device control and monitoring, COM port supports RS-232 up to 115.2k baud with software handshaking
IR	Supports 1-way device control via infrared up to 1.2 MHz

Wireless Communications

RF Transceiver	infiNET EX® network 2-way RF, 2.4 GHz ISM Channels 11-26 (2400 to 2483.5 MHz), default channel 15; IEEE 802.15.4 compliant
Range	50 ft (15 m) to nearest mesh network device(s), subject to site-specific conditions and individual device capabilities, range between floors or ceilings is limited to one level ²

NOTE: Do not rack mount or stack multiple units when using wireless communications. Use care when positioning the device to avoid interference from nearby RF devices, obstructions, and metal surfaces.

Memory

SDRAM	1 GB
Flash	8 GB
Memory Card	Supports microSD® cards up to 32 GB
External Storage	Supports USB mass storage devices up to 1 TB

Connectors and Card Slots

MEMORY	(1) microSD memory card slot; Accepts one microSD card up to 32 GB for storage of log files
G	(1) 6-32 screw; Chassis ground lug
USB	(1) USB Type-A connector, female; USB 2.0 port for storage devices
IR IN	(1) 3.5 mm TRS mini phone jack; For connecting CNXRMIRD IR receiver; Allows IR wireless control from Crestron and third-party remotes using RC-5 IR commands
RELAY (1–2)	(1) 4-pin 3.5 mm detachable terminal block; Comprises (2) normally open, isolated relays; Rated 1A, 30VAC/VDC; MOV arc suppression across contacts
VER SI (1–2)	(1) 3-pin 3.5 mm detachable terminal block; Comprises (2) Versiport digital input/output or analog input ports (referenced to GND); Digital Input: Rated for 0–24VDC, input impedance 20k Ω , logic threshold >3.125V low/0 and <1.875V high/1; Digital Output: 250 mA sink from maximum 24VDC, catch diodes for use with real world loads; Analog Input: Rated for 0–10VDC, protected to 24VDC maximum, input impedance 21k Ω with pull-up resistor disabled; Programmable 5V, 2k Ω pull-up resistor per pin
COM	(1) 3-pin 3.5 mm detachable terminal block; Bidirectional RS-232 port; Up to 115.2k baud; software handshaking support
IR 1–4	(2) 4-pin 3.5 mm detachable terminal blocks; Comprises (4) IR output ports; IR output up to 1.2 MHz; 1-way serial TTL/RS-232 (0–5V) up to 115.2k baud; IRP2 IR emitters sold separately
EX/ER	(1) Connection for supplied antenna
CRESNET	(1) 4-pin 3.5 mm detachable terminal block; Cresnet server port ¹ ; Outputs power to Cresnet devices; See "Power" section below for additional details
LAN	(1) 8-pin RJ-45 connector, female; 100BASE-TX/1000BASE-T Ethernet port; PoE (Power over Ethernet) PD (Powered Device) port

Controls and Indicators

PWR	(1) Bicolor green/amber LED, indicates operating power is present; Amber indicates that the device is booting and is not yet ready to operate; Green indicates that the device is ready to operate
HW-R	(1) Push button, initiates a hardware reset

SW-R	(1) Push button, initiates a software reset
ACQUIRE	(1) Red LED and (1) push button; LED indicates that Acquire mode is active; Push button initiates Acquire mode for pairing wireless devices
LAN	(1) Bicolor green/amber and (1) amber LEDs; Green/amber LED indicates Ethernet link status and connection speed; Amber LED indicates Ethernet activity

Power

Power over Ethernet (PoE)	IEEE 802.3at Type 1 (802.3af compatible) Class 0 (12.95 W) PoE Powered Device
Available Cresnet Power	2.5 W
Power Consumption	7 W

Environmental

Temperature	41 to 113°F (5 to 45°C)
Humidity	10% to 90% RH (noncondensing)
Heat Dissipation	24 BTU/hr

Enclosure

Chassis	Metal, black finish, with (2) integral mounting flanges, vented top, sides, and bottom
Mounting	Freestanding, surface mount, attach to a single rack rail, or 1 RU 19-in. rack mountable (rack ears included)

Dimensions

Height	1.07 in. (27 mm)
Width	10.15 in. (258 mm)
Depth	5.11 in. (130 mm)

Weight

2.7 lb (1.20 kg)
11.0 lb (5.00 kg)

Compliance

Regulatory Model: M201910001;
IC, FCC Part 15 Class B digital device

To search for product certificates, refer to support.crestron.com/app/certificates.

Dimension Drawings

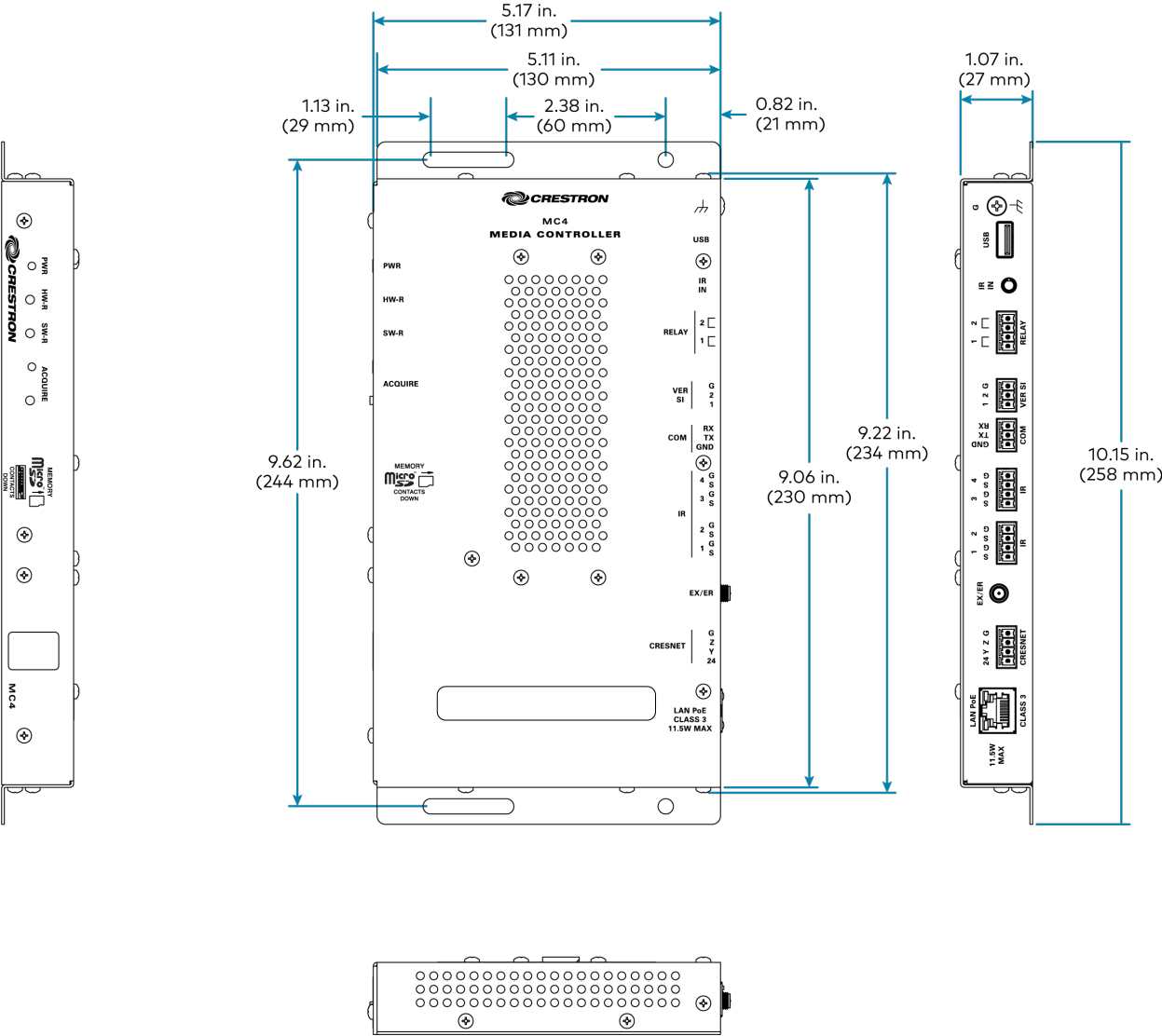

Notes:

1. Modular Programming Architecture (MPA) on the MC4 requires the purchase of one [SW-RMC3-10PROG](#) license. The license enables support for running up to 10 simultaneous programs on a single MC4. The license is not required if only one program is run on the MC4. To obtain a license for the MC4, complete the [Request for SW-RMC3-10PROG License form](#). For questions, contact license@crestron.com.
2. The total range of an infiNET EX® wireless network is dependent on the placement and capabilities of each network device. A mesh network topology is employed so every EX device on the network acts as a routing node or expander, which relays the signals it receives on to other EX devices within range. This effectively extends the total range of the network and provides multiple redundant signal paths for extra reliability. A maximum of six hops across routing nodes is allowed, although a maximum of three is recommended. Battery-powered infiNET EX devices only operate as leaf nodes and do not provide expander functionality. Up to 100 infiNET EX devices are permitted, although best practices suggest a limit of 50. Up to 15 external gateways ([CEN-GWEXER](#)) may be added to support additional devices (RF conditions allowing). Refer to the [Installation and Setup of Crestron RF Products Best Practices Guide](#) for additional guidelines.

3. A BACnet and IP license is required. A free license is available to support up to 50 BACnet objects on a single 4-Series control system. Support for more than 50 BACnet objects requires the purchase of one [SW-3SERIES-BACNET-50+](#) license. The MC4 supports a maximum of 500 BACnet objects when dedicated for BACnet use only. Actual capabilities are contingent upon the overall program size and complexity. To obtain the license, visit www.crestron.com/bacnetlicense.
4. This feature is only available when using the TSR-310. Other Crestron touch screens, handheld remotes, and keypads are not supported. For these interfaces, traditional IR or CEC control must be used to control supported Apple devices.

MC4-I Specifications

Product specifications for the MC4-I are provided below.

Product Specifications

Control Engine

Crestron 4-Series™ control processor; real-time, preemptive multithreaded/multitasking kernel; Transaction-Safe Extended FAT file system; supports up to 10 simultaneously-running programs (license required¹), native .AV Framework™ software program

Wired Communications

Ethernet	100/1000 Mbps, autoswitching, autonegotiating, autodiscovery, full/half duplex, industry-standard TCP/IP stack, UDP/IP, CIP, DHCP, SSL, TLS, SSH, SFTP (SSH File Transfer Protocol), FIPS 140-2 compliant encryption, IEEE 802.1X, SNMP, BACnet and IP ³ , IPv4 or IPv6, Active Directory® service authentication, HTTPS web server, HTTPS web browser setup and XiO Cloud® client, SMTP email client
Cresnet® Network	Cresnet server mode
USB	Supports USB mass storage class devices via the rear panel USB 2.0 host port
RS-232	For 2-way device control and monitoring, COM port supports RS-232 up to 115.2k baud with software handshaking
IR	Supports 1-way device control via infrared up to 1.2 MHz

Wireless Communications

RF Transceiver	infiNET EX® network 2-way RF, 2.4 GHz ISM Channels 11-26 (2400 to 2483.5 MHz), default channel 15; IEEE 802.15.4 compliant
Range	15 m (50 ft) to nearest mesh network device(s), subject to site-specific conditions and individual device capabilities, range between floors or ceilings is limited to one level ²

NOTE: Do not rack mount or stack multiple units when using wireless communications. Use care when positioning the device to avoid interference from nearby RF devices, obstructions, and metal surfaces.

Memory

SDRAM	1 GB
Flash	8 GB
Memory Card	Supports microSD® cards up to 32 GB
External Storage	Supports USB mass storage devices up to 1 TB

Connectors and Card Slots

MEMORY	(1) microSD memory card slot; Accepts one microSD card up to 32 GB for storage of log files
G	(1) 6-32 screw; Chassis ground lug
USB	(1) USB Type-A connector, female; USB 2.0 port for storage devices
IR IN	(1) 3.5 mm TRS mini phone jack; For connecting CNXRMIRD IR receiver; Allows IR wireless control from Crestron and third-party remotes using RC-5 IR commands
RELAY (1–2)	(1) 4-pin 3.5 mm detachable terminal block; Comprises (2) normally open, isolated relays; Rated 1A, 30VAC/VDC; MOV arc suppression across contacts
VER SI (1–2)	(1) 3-pin 3.5 mm detachable terminal block; Comprises (2) Versiport digital input/output or analog input ports (referenced to GND); Digital Input: Rated for 0–24VDC, input impedance 20k Ω , logic threshold >3.125V low/0 and <1.875V high/1; Digital Output: 250 mA sink from maximum 24VDC, catch diodes for use with real world loads; Analog Input: Rated for 0–10VDC, protected to 24VDC maximum, input impedance 21k Ω with pull-up resistor disabled; Programmable 5V, 2k Ω pull-up resistor per pin
COM	(1) 3-pin 3.5 mm detachable terminal block; Bidirectional RS-232 port; Up to 115.2k baud; software handshaking support
IR 1–4	(2) 4-pin 3.5 mm detachable terminal blocks; Comprises (4) IR output ports; IR output up to 1.2 MHz; 1-way serial TTL/RS-232 (0–5V) up to 115.2k baud; IRP2 IR emitters sold separately
EX/ER	(1) Connection for supplied antenna
CRESNET	(1) 4-pin 3.5 mm detachable terminal block; Cresnet server port ¹ ; Outputs power to Cresnet devices; See "Power" section below for additional details
LAN	(1) 8-pin RJ-45 connector, female; 100BASE-TX/1000BASE-T Ethernet port; PoE (Power over Ethernet) PD (Powered Device) port

Controls and Indicators

PWR	(1) Bicolor green/amber LED, indicates operating power is present; Amber indicates that the device is booting and is not yet ready to operate; Green indicates that the device is ready to operate
HW-R	(1) Push button, initiates a hardware reset

SW-R	(1) Push button, initiates a software reset
ACQUIRE	(1) Red LED and (1) push button; LED indicates that Acquire mode is active; Push button initiates Acquire mode for pairing wireless devices
LAN	(1) Bicolor green/amber and (1) amber LEDs; Green/amber LED indicates Ethernet link status and connection speed; Amber LED indicates Ethernet activity

Power

Power over Ethernet (PoE)	IEEE 802.3at Type 1 (802.3af compatible) Class 0 (12.95 W) PoE Powered Device
Available Cresnet Power	2.5 W
Power Consumption	7 W

Environmental

Temperature	5 to 45°C (41 to 113°F)
Humidity	10% to 90% RH (noncondensing)
Heat Dissipation	24 BTU/hr

Enclosure

Chassis	Metal, black finish, with (2) integral mounting flanges, vented top, sides, and bottom
Mounting	Freestanding, surface mount, attach to a single rack rail, or 1 RU 19-in. rack mountable (rack ears included)

Dimensions

Height	27 mm (1.07 in.)
Width	258 mm (10.15 in.)
Depth	130 mm (5.11 in.)

Weight

1.20 kg (2.7 lb)

Compliance

Regulatory Model: M201910001;
CE, IC, FCC Part 15 Class B digital device

To search for product certificates, refer to support.crestron.com/app/certificates.

Dimension Drawings

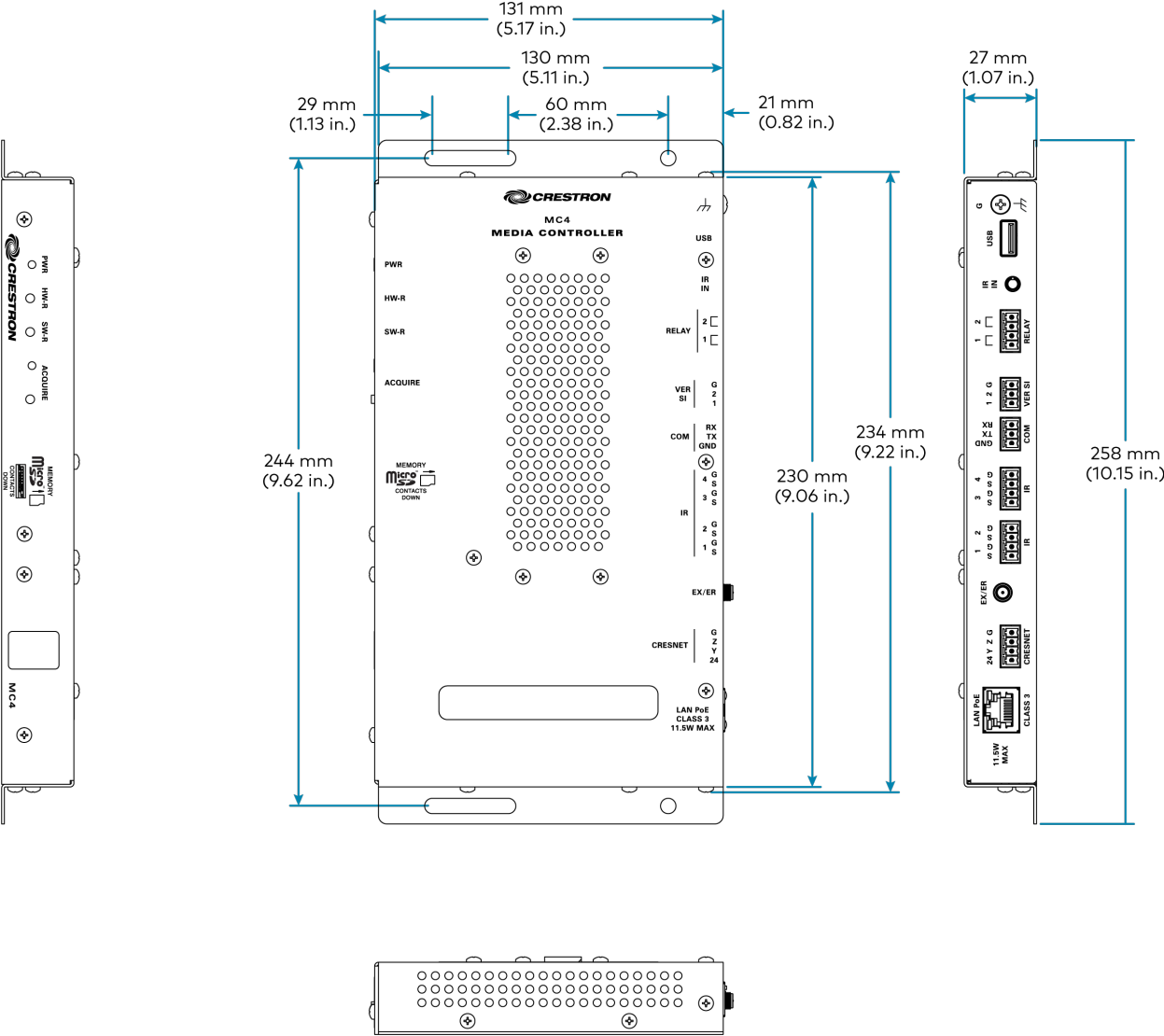

Notes:

1. Modular Programming Architecture (MPA) on the MC4-I requires the purchase of one [SW-RMC3-10PROG](#) license. The license enables support for running up to 10 simultaneous programs on a single MC4-I. The license is not required if only one program is run on the MC4-I. To obtain a license for the MC4-I, complete the [Request for SW-RMC3-10PROG License form](#). For questions, contact license@crestron.com.
2. The total range of an infiNET EX® wireless network is dependent on the placement and capabilities of each network device. A mesh network topology is employed so every EX device on the network acts as a routing node or expander, which relays the signals it receives on to other EX devices within range. This effectively extends the total range of the network and provides multiple redundant signal paths for extra reliability. A maximum of six hops across routing nodes is allowed, although a maximum of three is recommended. Battery-powered infiNET EX devices only operate as leaf nodes and do not provide expander functionality. Up to 100 infiNET EX devices are permitted, although best practices suggest a limit of 50. Up to 15 external gateways ([CEN-GWEXER](#)) may be added to support additional devices (RF conditions allowing). Refer to the [Installation and Setup of Crestron RF Products Best Practices Guide](#) for additional guidelines.

3. A BACnet and IP license is required. A free license is available to support up to 50 BACnet objects on a single 4-Series control system. Support for more than 50 BACnet objects requires the purchase of one [SW-3SERIES-BACNET-50+](#) license. The MC4-I supports a maximum of 500 BACnet objects when dedicated for BACnet use only. Actual capabilities are contingent upon the overall program size and complexity. To obtain the license, visit www.crestron.com/bacnetlicense.
4. This feature is only available when using the TSR-310. Other Crestron touch screens, handheld remotes, and keypads are not supported. For these interfaces, traditional IR or CEC control must be used to control supported Apple devices.

MC4-R Specifications

Product specifications for the MC4-R are provided below.

Product Specifications

Wired Communications

Ethernet	100/1000 Mbps, autoswitching, autonegotiating, autodiscovery, full/half duplex, industry-standard TCP/IP stack, UDP/IP, CIP, DHCP, SSL, TLS, SSH, SFTP (SSH File Transfer Protocol), FIPS 140-2 compliant encryption, IPv4 or IPv6, HTTPS web server, SMTP email client
Cresnet® Network	Cresnet server mode ¹
USB	Supports USB mass storage class devices via the rear panel USB 2.0 host port
RS-232	For 2-way device control and monitoring, COM port supports RS-232 up to 115.2k baud with software handshaking
IR	Supports 1-way device control via infrared up to 1.2 MHz

Wireless Communications

RF Transceiver	infiNET EX® network 2-way RF, 2.4 GHz ISM Channels 11-26 (2400 to 2483.5 MHz), default channel 15; IEEE 802.15.4 compliant
Range	50 ft (15 m) to nearest mesh network device(s), subject to site-specific conditions and individual device capabilities, range between floors or ceilings is limited to one level ²

NOTE: Do not rack mount or stack multiple units when using wireless communications. Use care when positioning the device to avoid interference from nearby RF devices, obstructions, and metal surfaces.

Memory

SDRAM	2 GB
Flash	8 GB
Memory Card	Supports microSD® cards up to 32 GB (4 GB microSD card included)
External Storage	Supports USB mass storage devices up to 1 TB

Connectors and Card Slots

MEMORY	(1) microSD memory card slot; Accepts one microSD card up to 32 GB for storage of log files 4 GB microSD card included
G	(1) 6-32 screw; Chassis ground lug
USB	(1) USB Type-A connector, female; USB 2.0 port for storage devices

IR IN	(1) 3.5 mm TRS mini phone jack; For connecting CNXRMIRD IR receiver; Allows IR wireless control from Crestron and third-party remotes using RC-5 IR commands
RELAY (1-2)	(1) 4-pin 3.5 mm detachable terminal block; Comprises (2) normally open, isolated relays; Rated 1A, 30VAC/VDC; MOV arc suppression across contacts
VER SI (1-2)	(1) 3-pin 3.5 mm detachable terminal block; Comprises (2) Versiport digital input/output or analog input ports (referenced to GND); Digital Input: Rated for 0–24VDC, input impedance 20k Ω , logic threshold >3.125V low/0 and <1.875V high/1; Digital Output: 250 mA sink from maximum 24VDC, catch diodes for use with real world loads; Analog Input: Rated for 0–10VDC, protected to 24VDC maximum, input impedance 21k Ω with pull-up resistor disabled; Programmable 5V, 2k Ω pull-up resistor per pin
COM	(1) 3-pin 3.5 mm detachable terminal block; Bidirectional RS-232 port; Up to 115.2k baud; software handshaking support
IR 1-4	(2) 4-pin 3.5 mm detachable terminal blocks; Comprises (4) IR output ports; IR output up to 1.2 MHz; 4 IRP2 IR emitters included, additional emitters sold separately
EX/ER	(1) Connection for supplied antenna
CRESNET	(1) 4-pin 3.5 mm detachable terminal block; Cresnet server port ¹ ; Outputs power to Cresnet devices; See "Power" section below for additional details
LAN	(1) 8-pin RJ-45 connector, female; 100BASE-TX/1000BASE-T Ethernet port; PoE (Power over Ethernet) PD (Powered Device) port

Controls and Indicators

PWR	(1) Bicolor green/amber LED, indicates operating power is present; Amber indicates that the device is booting and is not yet ready to operate; Green indicates that the device is ready to operate
HW-R	(1) Push button, initiates a hardware reset
SW-R	(1) Push button, initiates a software reset
ACQUIRE	(1) Red LED and (1) push button; LED indicates that Acquire mode is active; Push button initiates Acquire mode for pairing wireless devices
LAN	(1) Bicolor green/amber and (1) amber LEDs; Green/amber LED indicates Ethernet link status and connection speed; Amber LED indicates Ethernet activity

Power

Power over Ethernet (PoE)	IEEE 802.3at Type 1 (802.3af compatible) Class 0 (12.95 W) PoE Powered Device
Available Cresnet Power	2.5 W
Power Consumption	7 W

Environmental

Temperature	41 to 113°F (5 to 45°C)
Humidity	10% to 90% RH (noncondensing)
Heat Dissipation	24 BTU/hr

Enclosure

Chassis	Metal, black finish, with (2) integral mounting flanges, vented top, sides, and bottom
Mounting	Freestanding, surface mount, attach to a single rack rail, or 1 RU 19-in. rack mountable (rack ears included)

Dimensions

Height	1.07 in. (27 mm)
Width	10.15 in. (258 mm)
Depth	5.11 in. (130 mm)

Weight

1.0 lb (454 g)

Compliance

Regulatory Model: M201910001;
IC, FCC Part 15 Class B digital device

To search for product certificates, refer to support.crestron.com/app/certificates.

Dimension Drawings

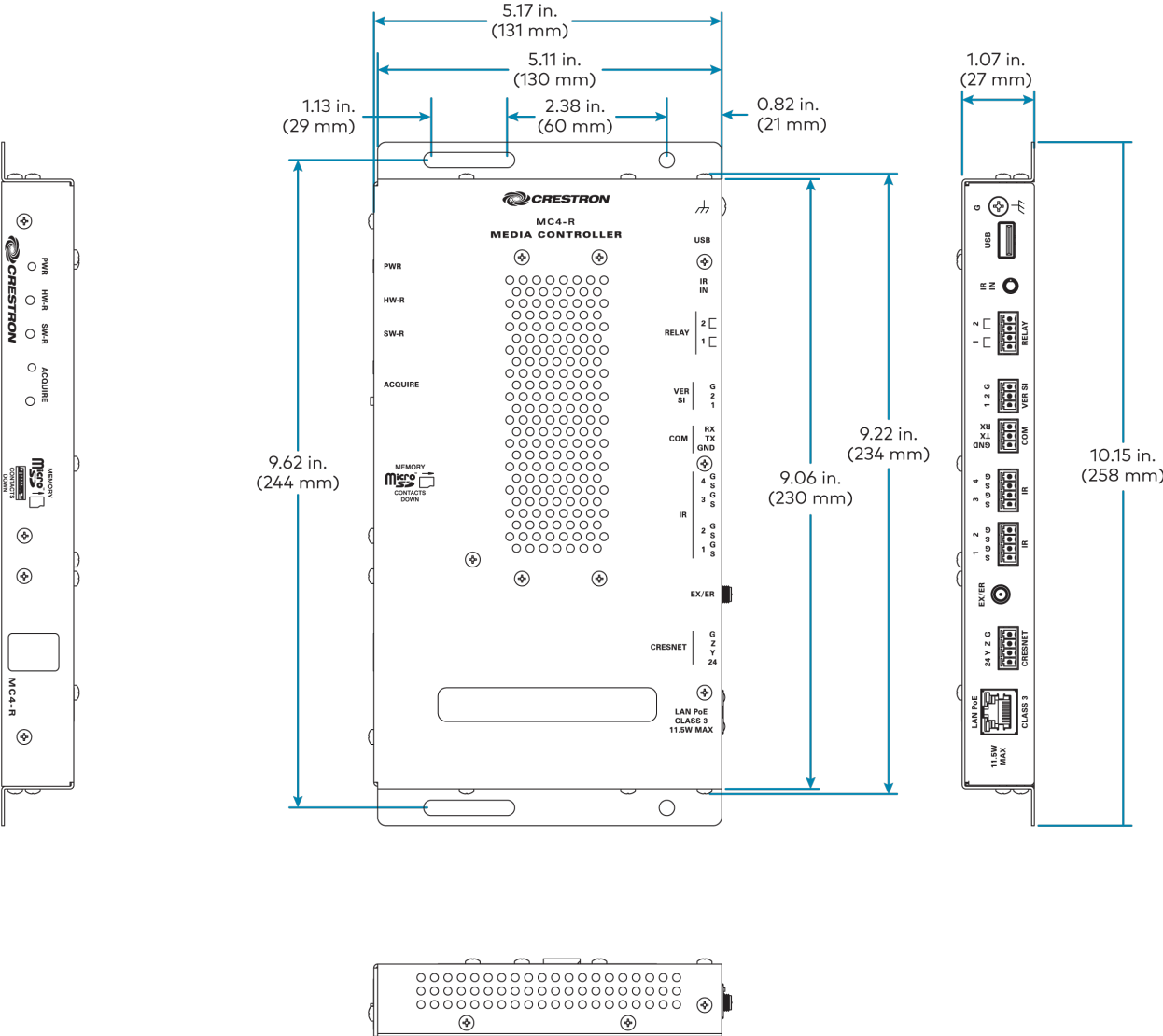

Notes:

1. The Cresnet® network port (NET) and infiNET EX® transceiver are strictly for use with specific Crestron® devices that work with Crestron Home® OS. For a list of compatible devices, visit www.crestron.com/crestronhome.
2. The total range of an infiNET EX wireless network is dependent on the placement and capabilities of each network device. A mesh network topology is employed so every "EX" device on the network acts as a routing node or "expander," which relays the signals it receives on to other EX devices within range. This effectively extends the total range of the network and provides multiple redundant signal paths for extra reliability. A maximum of six "hops" across routing nodes is allowed, although a maximum of three is recommended. Battery-powered infiNET EX devices only operate as leaf nodes and do not provide expander functionality. Up to 100 infiNET EX devices are permitted, although best practices suggest a limit of 50. Up to 15 external gateways (CEN-GWEXER sold separately) may be added to support additional devices (RF conditions allowing). Refer to the [Installation and Setup of Crestron RF Products Best Practices Guide](#) for additional guidelines.
3. Up to 2000 BACnet objects are supported out of the box with no licensing required.

MC4-R-I Specifications

Product specifications for the MC4-R-I are provided below.

Product Specifications

Wired Communications

Ethernet	100/1000 Mbps, autoswitching, autonegotiating, autodiscovery, full/half duplex, industry-standard TCP/IP stack, UDP/IP, CIP, DHCP, SSL, TLS, SSH, SFTP (SSH File Transfer Protocol), FIPS 140-2 compliant encryption, IPv4 or IPv6, HTTPS web server, SMTP email client
Cresnet® Network	Cresnet server mode ¹
USB	Supports USB mass storage class devices via the rear panel USB 2.0 host port
RS-232	For 2-way device control and monitoring, COM port supports RS-232 up to 115.2k baud with software handshaking
IR	Supports 1-way device control via infrared up to 1.2 MHz

Wireless Communications

RF Transceiver	infiNET EX® network 2-way RF, 2.4 GHz ISM Channels 11-26 (2400 to 2483.5 MHz), default channel 15; IEEE 802.15.4 compliant
Range	15 m (50 ft) to nearest mesh network device(s), subject to site-specific conditions and individual device capabilities, range between floors or ceilings is limited to one level ²

NOTE: Do not rack mount or stack multiple units when using wireless communications. Use care when positioning the device to avoid interference from nearby RF devices, obstructions, and metal surfaces.

Memory

SDRAM	2 GB
Flash	8 GB
Memory Card	Supports microSD® cards up to 32 GB (4 GB microSD card included)
External Storage	Supports USB mass storage devices up to 1 TB

Connectors and Card Slots

MEMORY	(1) microSD memory card slot; Accepts one microSD card up to 32 GB for storage of log files 4 GB microSD card included
G	(1) 6-32 screw; Chassis ground lug
USB	(1) USB Type-A connector, female; USB 2.0 port for storage devices

IR IN	(1) 3.5 mm TRS mini phone jack; For connecting CNXRMIRD IR receiver; Allows IR wireless control from Crestron and third-party remotes using RC-5 IR commands
RELAY (1-2)	(1) 4-pin 3.5 mm detachable terminal block; Comprises (2) normally open, isolated relays; Rated 1A, 30VAC/VDC; MOV arc suppression across contacts
VER SI (1-2)	(1) 3-pin 3.5 mm detachable terminal block; Comprises (2) Versiport digital input/output or analog input ports (referenced to GND); Digital Input: Rated for 0–24VDC, input impedance 20k Ω , logic threshold >3.125V low/0 and <1.875V high/1; Digital Output: 250 mA sink from maximum 24VDC, catch diodes for use with real world loads; Analog Input: Rated for 0–10VDC, protected to 24VDC maximum, input impedance 21k Ω with pull-up resistor disabled; Programmable 5V, 2k Ω pull-up resistor per pin
COM	(1) 3-pin 3.5 mm detachable terminal block; Bidirectional RS-232 port; Up to 115.2k baud; software handshaking support
IR 1-4	(2) 4-pin 3.5 mm detachable terminal blocks; Comprises (4) IR output ports; IR output up to 1.2 MHz; 4 IRP2 IR emitters included, additional emitters sold separately
EX/ER	(1) Connection for supplied antenna
CRESNET	(1) 4-pin 3.5 mm detachable terminal block; Cresnet server port ¹ ; Outputs power to Cresnet devices; See "Power" section below for additional details
LAN	(1) 8-pin RJ-45 connector, female; 100BASE-TX/1000BASE-T Ethernet port; PoE (Power over Ethernet) PD (Powered Device) port

Controls and Indicators

PWR	(1) Bicolor green/amber LED, indicates operating power is present; Amber indicates that the device is booting and is not yet ready to operate; Green indicates that the device is ready to operate
HW-R	(1) Push button, initiates a hardware reset
SW-R	(1) Push button, initiates a software reset
ACQUIRE	(1) Red LED and (1) push button; LED indicates that Acquire mode is active; Push button initiates Acquire mode for pairing wireless devices
LAN	(1) Bicolor green/amber and (1) amber LEDs; Green/amber LED indicates Ethernet link status and connection speed; Amber LED indicates Ethernet activity

Power

Power over Ethernet (PoE)	IEEE 802.3at Type 1 (802.3af compatible) Class 0 (12.95 W) PoE Powered Device
Available Cresnet Power	2.5 W
Power Consumption	7 W

Environmental

Temperature	5 to 45°C (41 to 113°F)
Humidity	10% to 90% RH (noncondensing)
Heat Dissipation	24 BTU/hr

Enclosure

Chassis	Metal, black finish, with (2) integral mounting flanges, vented top, sides, and bottom
Mounting	Freestanding, surface mount, attach to a single rack rail, or 1 RU 19-in. rack mountable (rack ears included)

Dimensions

Height	27 mm (1.07 in.)
Width	258 mm (10.15 in.)
Depth	130 mm (5.11 in.)

Weight

454 g (1.0 lb)

Compliance

Regulatory Model: M201910001;
CE, IC, FCC Part 15 Class B digital device

To search for product certificates, refer to support.crestron.com/app/certificates.

Dimension Drawings

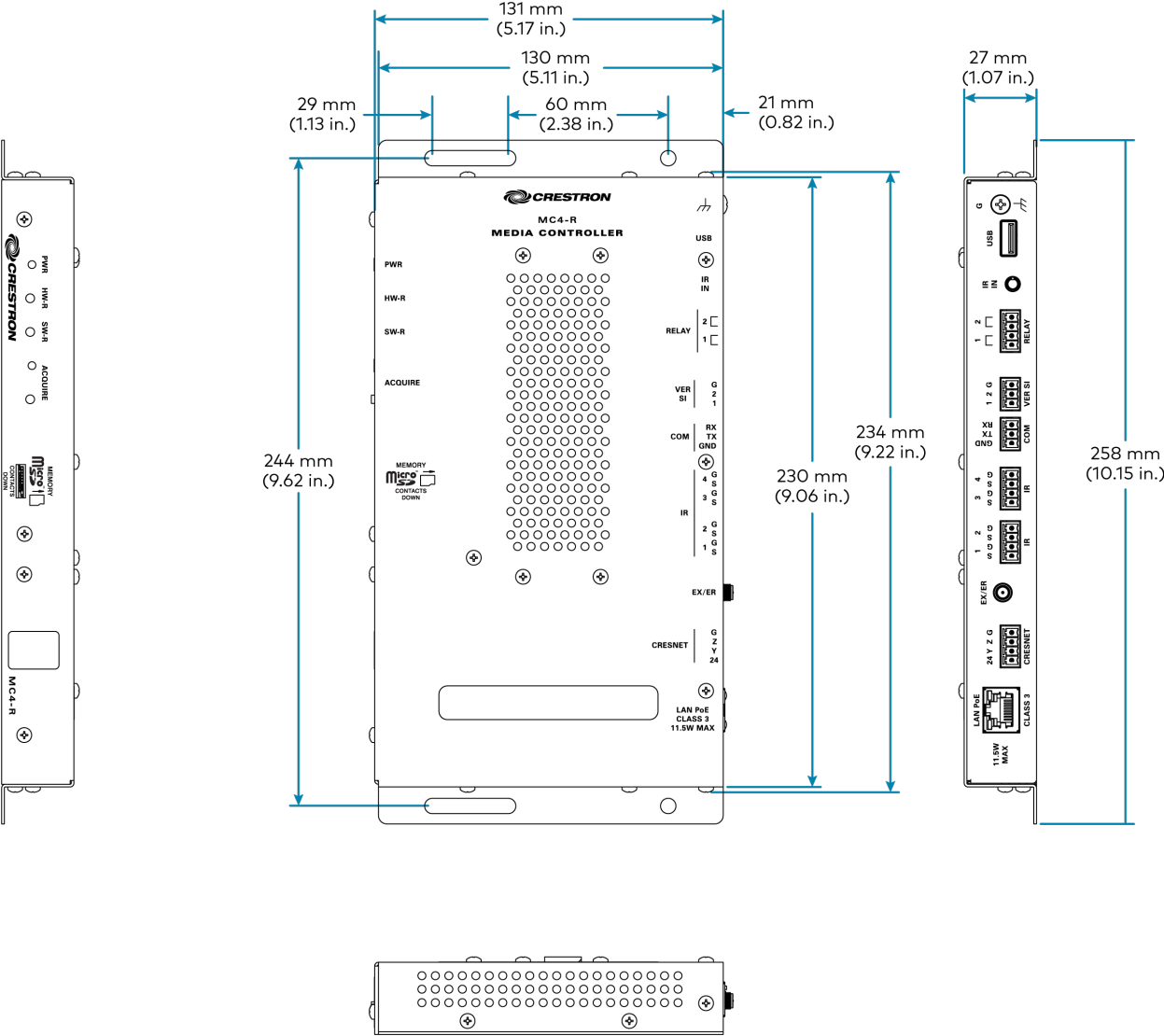

Notes:

1. The Cresnet® network port (NET) and infiNET EX® transceiver are strictly for use with specific Crestron® devices that work with Crestron Home® OS. For a list of compatible devices, visit www.crestron.com/crestronhome.
2. The total range of an infiNET EX wireless network is dependent on the placement and capabilities of each network device. A mesh network topology is employed so every "EX" device on the network acts as a routing node or "expander," which relays the signals it receives on to other EX devices within range. This effectively extends the total range of the network and provides multiple redundant signal paths for extra reliability. A maximum of six "hops" across routing nodes is allowed, although a maximum of three is recommended. Battery-powered infiNET EX devices only operate as leaf nodes and do not provide expander functionality. Up to 100 infiNET EX devices are permitted, although best practices suggest a limit of 50. Up to 15 external gateways (CEN-GWEXER sold separately) may be added to support additional devices (RF conditions allowing). Refer to the [Installation and Setup of Crestron RF Products Best Practices Guide](#) for additional guidelines.
3. Up to 2000 BACnet objects are supported out of the box with no licensing required.

PRO4 Specifications

Product specifications for the PRO4 are provided below.

Product Specifications

Control Engine

Crestron 4-Series™ control processor; real-time, preemptive multithreaded/multitasking kernel; Transaction-Safe Extended FAT file system; supports up to 10 simultaneously-running programs, native .AV Framework™ software program

Ethernet	100/1000 Mbps, autoswitching, autonegotiating, autodiscovery, full/half duplex, industry-standard TCP/IP stack, UDP/IP, CIP, DHCP, SSL, TLS, SSH, SFTP (SSH File Transfer Protocol), FIPS 140-2 compliant encryption, IEEE 802.1X, SNMP, BACnet and IP ² , IPv4 or IPv6, Active Directory® service authentication, HTTPS web server, HTTPS web browser setup and XiO Cloud® client, SMTP email client
Control Subnet	100/1000 Mbps Ethernet, autoswitching, autonegotiating, autodiscovery, full/half duplex, DHCP server, DNS server, port forwarding, isolation mode, IEEE 802.3at Type 1 compliant PoE PSE
Cresnet® Network	Cresnet server mode
USB	Supports USB mass storage class devices via the rear panel USB 2.0 host port, supports computer console via the front panel USB 2.0 device port
RS-232/422/485	For 2-way device control and monitoring, COM port supports RS-232 up to 115.2k baud with software handshaking, one port also supports RS-422 or RS-485 and hardware handshaking
IR/Serial	Supports 1-way device control via infrared up to 1.2 MHz or serial TTL/RS-232 (0–5V) up to 115.2k baud

Memory

SDRAM	2 GB
Flash	8 GB
Memory Card	Supports SD and SDHC cards up to 32 GB
External Storage	Supports USB mass storage devices up to 1 TB

Connectors and Card Slots

S1–S3	(3) Control card expansion slots
COM 1–2	(2) 5-pin 3.5 mm detachable terminal blocks; Bidirectional RS-232/422/485 ports; Up to 115.2k baud; hardware and software handshaking support
COM 3–6	(4) 3-pin 3.5 mm detachable terminal blocks; Bidirectional RS-232 ports; Up to 115.2k baud; software handshaking support

IR - SERIAL OUTPUT 1-8	(2) 8-pin 3.5 mm detachable terminal blocks; Comprises (8) IR output ports; IR output up to 1.2 MHz; 1-way serial TTL/RS-232 (0-5V) up to 115.2k baud; IRP2 IR emitters sold separately
RELAY OUTPUT 1-8	(2) 8-pin 3.5 mm detachable terminal blocks; Comprises (8) normally open, isolated relays; Rated 1A, 30VAC/VDC; MOV arc suppression across contacts
PoE+ INPUT POWER	(1) Combo D-Sub 7w2 connector, male; 54VDC power input for PoE+ power supply; Enables PoE+ power sourcing on the CONTROL SUBNET ports
CONTROL SUBNET	(4) 8-pin RJ-45 connectors, female; 100BASE-TX/1000BASE-T Ethernet port; PoE+ PSE (Power Sourcing Equipment) port; Provides a dedicated local network for Crestron devices
LAN	(1) 8-pin RJ-45 connector, female; 100BASE-TX/1000BASE-T Ethernet port
USB	(1) USB Type-A connector, female; USB 2.0 port for storage devices
MEMORY	(1) SD memory card slot; Accepts one SD or SDHC card up to 32 GB for storage of log files
I/O 1-8	(1) 9-pin 3.5 mm detachable terminal block; Comprises (8) Versiport digital input/output or analog input ports (referenced to GND); Digital Input: Rated for 0-24VDC, input impedance 20k Ω , logic threshold >3.125V low/0 and <1.875V high/1; Digital Output: 250 mA sink from maximum 24VDC, catch diodes for use with real world loads; Analog Input: Rated for 0-10VDC, protected to 24VDC maximum, input impedance 21k Ω with pull-up resistor disabled; Programmable 5V, 2k Ω pull-up resistor per pin
NET	(1) 4-pin 3.5 mm detachable terminal block; Cresnet server port; Outputs power to Cresnet devices; Alternately functions as a Cresnet power input to power the unit from a Cresnet power supply; See "Power" section below for additional details
100-240V~ 2.4A 50/60Hz	(1) IEC 60320 C14 main power inlet; Mates with removable power cord
G	(1) 6-32 screw; Chassis ground lug
COMPUTER (front)	(1) USB Type-B connector, female; USB 2.0 computer console port; For setup only

LCD Display

Display Type	TFT active matrix color LCD
Size	2.8 in. (72 mm) diagonal
Resolution	320 x 240 pixels
Functions	Displays configuration menus, control port activity, and other system information

Controls and Indicators

PWR	(1) Bicolor green/amber LED, indicates operating power is present; Amber indicates that the device is booting and is not yet ready to operate; Green indicates that the device is ready to operate
NET	(1) Amber LED, indicates communication with Cresnet devices
MSG	(1) Red LED, indicates control processor has generated a logging message
HW-R	(1) Recessed push button, initiates a hardware reset
SW-R	(1) Recessed push button, initiates a software reset
CNPS FAULT	(1) Red LED and (1) push button; LED indicates an excessive Cresnet load is detected at the NET port; Push button resets the fault indication
SLOT 1–3	(3) Green LEDs, indicates control cards are present in the corresponding rear panel slots
Nav Pad	(1) 5-way navigation pad for LCD display menu navigation and parameter adjustment
HOME	(1) Push button, returns to the LCD display home menu
BACK	(1) Push button, returns to the previous screen on the LCD display
LAN	(1) Bicolor green/amber and (1) amber LEDs; Green/amber LED indicates Ethernet link status and connection speed; Amber LED indicates Ethernet activity
CONTROL SUBNET (rear)	(1) Bicolor green/amber and (1) amber LEDs; Green/amber LED indicates Ethernet link status and connection speed; Amber LED indicates Ethernet activity

Power

Main Power	2.4A @ 100–240VAC, 50/60Hz
Power over Ethernet Plus (PoE+)	IEEE 802.3at compliant PoE+ PSE (Power Sourcing Equipment); 120 W total power; Each CONTROL SUBNET port supplies up to 30 W to power one PoE+ (Class 4) PD (Powered Device)
Available Cresnet Power	75 W (3.125A @ 24VDC)

Environmental

Temperature	41 to 104°F (5 to 40°C)
Humidity	10% to 90% RH (noncondensing)

Heat Dissipation 43 BTU/hr

Enclosure

Chassis	Steel, vented sides and top
Front Panel	Extruded metal, black finish, polycarbonate label overlay
Faceplate	Extruded metal, black finish, polycarbonate label overlay

Dimensions

Height	3.47 in. (89 mm) without feet
Width	17.28 in. (439 mm); 19.00 in. (483 mm) with rack ears
Depth	10.11 in. (257 mm)

Weight

Compliance

Regulatory Model: M201903001;
BV Listed for US & Canada, CE, IC, FCC Part 15 Class B digital device

To search for product certificates, refer to support.crestron.com/app/certificates.

Dimension Drawings

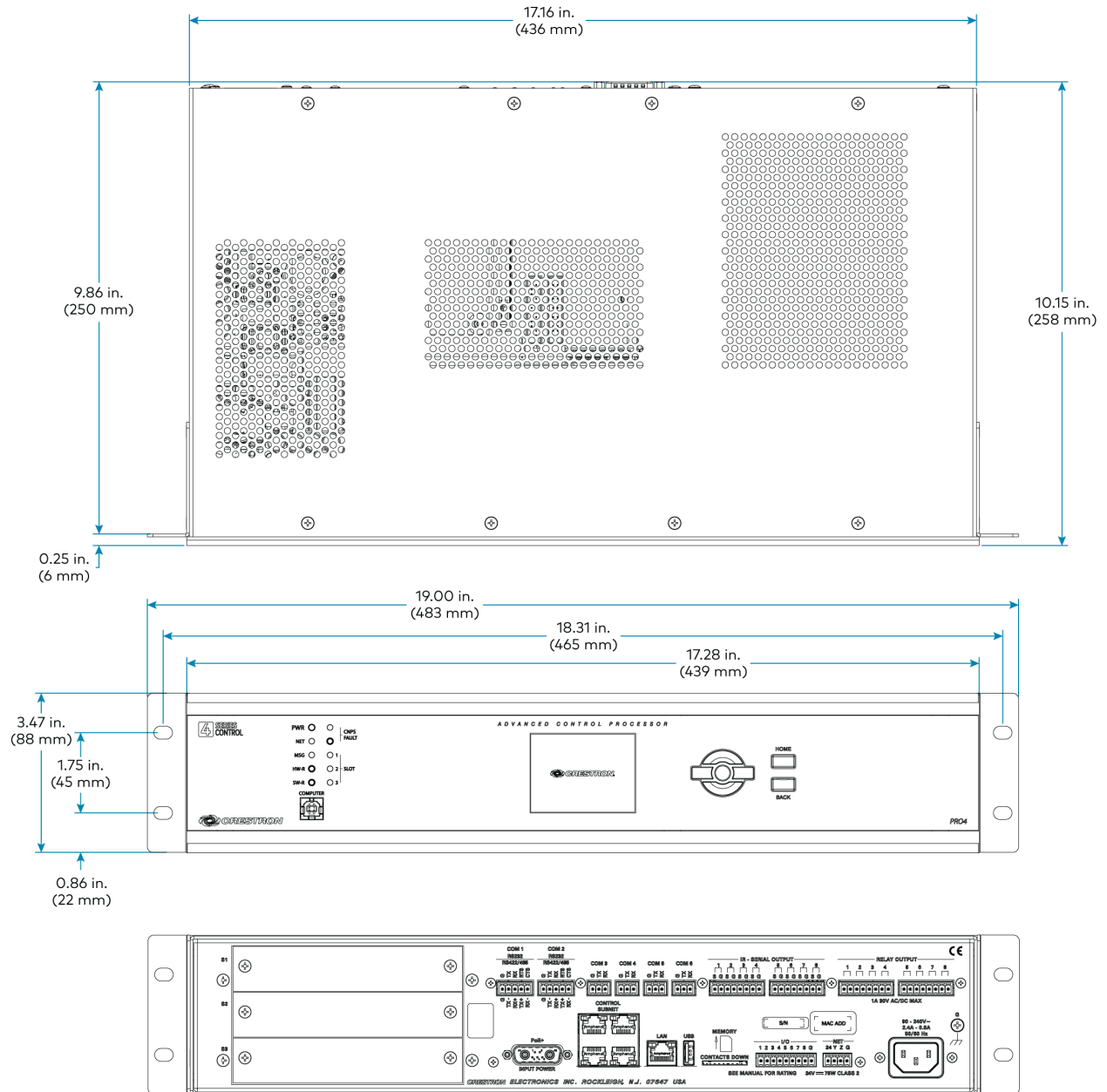

Notes:

1. The following connections comply with IEC 61000-4-5 Installation Class 4 surge immunity levels: COM 1–6, I/O 1–8, NET, LAN, and CONTROL SUBNET.
2. A BACnet and IP license is required. A free license is available to support up to 50 BACnet objects on a single 4-Series control system. Support for more than 50 BACnet objects requires the purchase of one [SW-3SERIES-BACNET-50+](#) license. The PRO4 supports a maximum of 2000 BACnet objects when dedicated for BACnet use only. Actual capabilities are contingent upon the overall program size and complexity. To obtain the license, visit www.crestron.com/bacnetlicense.
3. This feature is only available when using the TSR-310. Other Crestron touch screens, handheld remotes, and keypads are not supported. For these interfaces, traditional IR or CEC control must be used to control supported Apple devices.

RMC4 Specifications

Product specifications for the RMC4 are provided below.

Product Specifications

Control Engine

Crestron 4-Series™ control processor; real-time, preemptive multithreaded/multitasking kernel; Transaction-Safe Extended FAT file system; supports up to 10 simultaneously-running programs (license required¹), native .AV Framework™ software program

Ethernet	100 Mbps, autoswitching, autonegotiating, autodiscovery, full/half duplex, industry-standard TCP/IP stack, UDP/IP, CIP, DHCP, SSL, TLS, SSH, SFTP (SSH File Transfer Protocol), FIPS 140-2 compliant encryption, IEEE 802.1X, SNMP, BACnet and IP ³ , IPv4 or IPv6, Active Directory® service authentication, HTTPS web server, HTTPS web browser setup and XiO Cloud® client, SMTP email client
Cresnet® Network	Cresnet server mode
USB	Supports computer console and USB mass storage class devices via the front panel USB OTG (On-the-Go) device port
RS-232/422/485	For 2-way device control and monitoring, COM port supports RS-232 up to 115.2k baud with software handshaking, one port also supports RS-422 or RS-485 and hardware handshaking
IR/Serial	Supports 1-way device control via infrared up to 1.2 MHz or serial TTL/RS-232 (0–5V) up to 115.2k baud

Memory

SDRAM	1 GB
Flash	8 GB
External Storage	Supports USB mass storage devices up to 1 TB
USB-OTG	(1) USB Type Micro-AB female; USB OTG port for computer console and USB mass storage devices
LAN PoE	(1) 8-pin RJ-45 connector, female; 100BASE-T Ethernet port; PoE (Power over Ethernet) PD (Powered Device) port
NET	(1) 3-pin 3.5 mm detachable terminal block; Cresnet server port; Provides data only (no power) ²
DIGITAL IN 1–2	(1) 3-pin 3.5 mm detachable terminal block; Comprises (2) digital inputs (referenced to GND); Voltage Range: Rated for 0–24VDC; Input Impedance: 2.2k Ω pulled up to 5V; Logic Threshold: >2.0V low/0 and <1.1V high/1

RELAY 1–2	(1) 4-pin 3.5 mm detachable terminal block; Comprises (2) normally open, isolated relays; Rated 1A, 30VAC/VDC; MOV arc suppression across contacts
IR 1–2	(1) 4-pin 3.5 mm detachable terminal block; Comprises (2) IR output ports; IR output up to 1.2 MHz; 1-way serial TTL/RS-232 (0–5V) up to 115.2k baud; IRP2 IR emitters sold separately
COM	(1) 5-pin 3.5 mm detachable terminal block; Bidirectional RS-232/422/485 port; Up to 115.2k baud; hardware and software handshaking support
G	(1) 6-32 screw; Chassis ground lug

Controls and Indicators

PWR	(1) Bicolor green/amber LED, indicates operating power is present; Amber indicates that the device is booting and is not yet ready to operate; Green indicates that the device is ready to operate
NET	(1) Amber LED, indicates communication with Cresnet devices
MSG	(1) Red LED, indicates control processor has generated a logging message
HW-R	(1) Recessed push button, initiates a hardware reset
SW-R	(1) Recessed push button, initiates a software reset
LAN PoE	(1) Bicolor green/amber and (1) amber LEDs; Green/amber LED indicates Ethernet link status and connection speed; Amber LED indicates Ethernet activity

Power

Power over Ethernet (PoE)	IEEE 802.3at Type 1 (802.3af compatible) Class 0 (12.95 W) PoE Powered Device
Power Consumption	6.5 W

NOTE: The RMC4 does not use or supply any Cresnet® network power.

Environmental

Temperature	32 to 104°F (0 to 40°C)
Humidity	10% to 90% RH (noncondensing)
Operating Temperature	50 to 95°F (10 to 35°C)
Storage Temperature	-40 to 149°F (-40 to 65°C)
Heat Dissipation	42.9 BTU/hr (short idle)

Enclosure

Housing	IFE micro form factor, black and blue plastic
----------------	---

Mounting	Freestanding or 2 RU 19-in. rack mountable (adhesive feet and rack ears included)
Mounting	Freestanding, stackable, surface mount, or 35 mm DIN EN 60715 rail mount; Occupies 8 DIN module spaces (144 mm); Surface/DIN rail mounting bracket included, optional rack mount and pole mount kits sold separately

Dimensions

Height	1.35 in. (35 mm); 1.77 in. (45 mm) with bracket
Width	5.04 in. (128 mm); 5.36 in. (137 mm) with bracket
Depth	2.86 in. (73 mm)

Weight

12 oz (340 g)

Compliance

Regulatory Model: RMC4;

UL® Listed for US & Canada, CE, IC, FCC Part 15 Class B digital device

To search for product certificates, refer to support.crestron.com/app/certificates.

Dimension Drawings

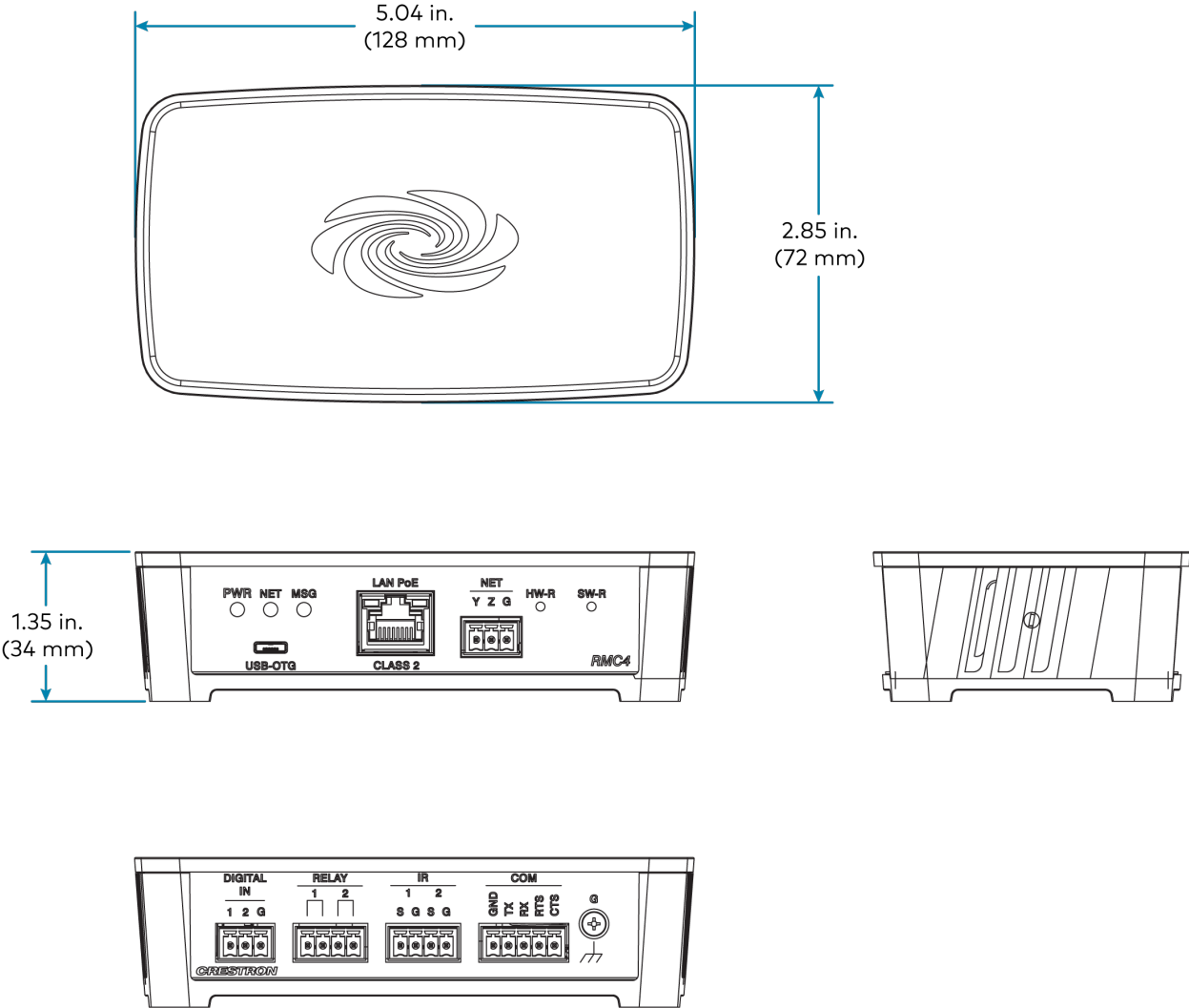

Notes:

1. Modular Programming Architecture (MPA) on the RMC4 requires the purchase of one [SW-RMC3-10PROG](#) license. The license enables support for running up to 10 simultaneous programs on a single RMC4. The license is not required if only one program is run on the RMC4. To obtain a license for the RMC4, complete the [Request for SW-RMC3-10PROG License form](#). For questions, contact license@crestron.com.
2. The NET (Cresnet® network) port on the RMC4 is a 3-pin connector which provides connectivity for Cresnet data only, not power. The Cresnet power conductor does not terminate to the RMC4. An external Cresnet power supply is required to provide power for Cresnet devices.
3. A BACnet and IP license is required. A free license is available to support up to 50 BACnet objects on a single 4-Series control system. Support for more than 50 BACnet objects requires the purchase of one [SW-3SERIES-BACNET-50+](#) license. The RMC4 supports a maximum of 500 BACnet objects when dedicated for BACnet use only. Actual capabilities are contingent upon the overall program size and complexity. To obtain the license, visit www.crestron.com/bacnetlicense.

4. This feature is only available when using the TSR-310. Other Crestron touch screens, handheld remotes, and keypads are not supported. For these interfaces, traditional IR or CEC control must be used to control supported Apple devices.

Installation

This section provides the following information:

- [AV4 Installation](#)
- [CP4 Installation](#)
- [CP4N Installation](#)
- [CP4-R Installation](#)
- [DIN-AP4 Installation](#)
- [DIN-AP4-R Installation](#)
- [MC4 Installation](#)
- [MC4-I Installation](#)
- [MC4-R Installation](#)
- [MC4-R-I Installation](#)
- [PRO4 Installation](#)
- [RMC4 Installation](#)

NOTE: For PC4-R, VC4, and VC-4-PC-3 installation, refer to [PC4-R Installation](#), [VC-4 Installation](#), and [VC-4-PC-3 Installation](#)

AV4 Installation

Use the following procedures to install the AV4.

In the Box

Qty.	Description
1	AV4, 4-Series™ Control System
Additional Items	
2	Bracket, Rack Ear (2056627)
4	Foot, Rubber (2002389)
4	Connector, 3-Pin (2003575)
1	Connector, 4-Pin (2003576)
2	Connector, 5-Pin (2003577)
4	Connector, 8-Pin (2003580)
1	Connector, 9-Pin (2003581)
1	Power Cord, 6 ft, 7 in. (2.01 m) (2001134)

Install the Control System

The control system may be mounted into a rack or placed onto a flat surface.

Rack Mounting

The control system occupies 2U of rack space.

1. Use a #1 Phillips screwdriver to remove the six required screws from the control system assembly (shown in the illustration below).
2. Attach the two included rack ears with the removed screws.
3. Mount the control system into the rack with four mounting screws (not included).

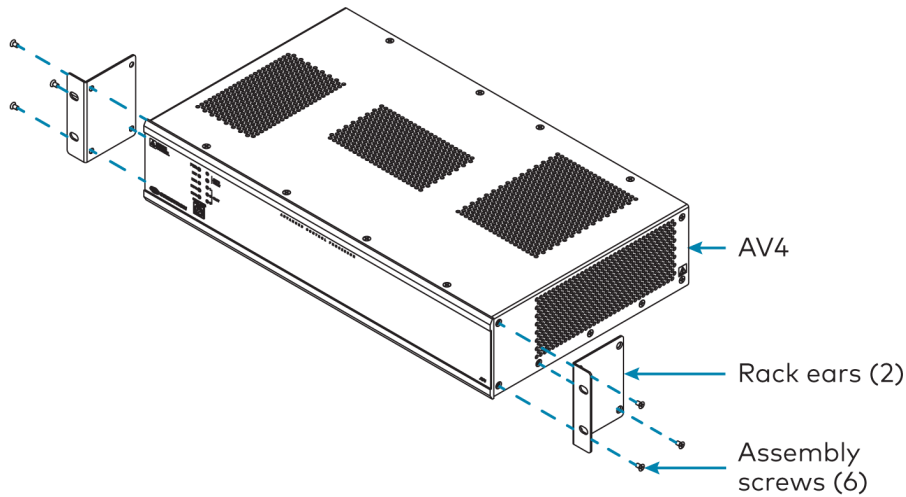

Surface Placement

1. Attach the four adhesive rubber feet near the corners on the underside of the control system.
2. Place onto a flat surface or stack with other equipment.

Connect the Control System

Make all necessary connections to the control system as shown in the following diagram.

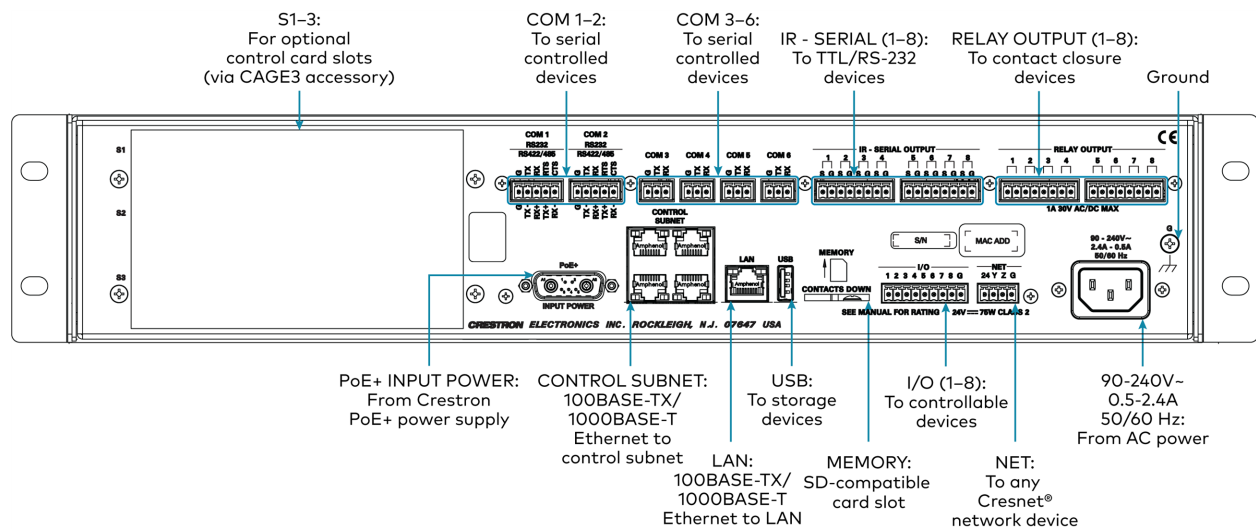

Observe the following when connecting the control system:

- Use Crestron power supplies for Crestron equipment.
- The **CONTROL SUBNET** ports are PoE+ PSE ports. Enabling PoE+ power sourcing requires connection of the **PoE+ INPUT POWER** port to an external Crestron power supply ([PW-5430DUS](#), sold separately). Wiring that connects to a PoE+ PSE is designed for intrabuilding use only.
- If PoE+ will be used, the PoE+ power supply must be connected to the control system before it is powered on.
- The **S1**, **S2**, and **S3** slots are designed to house [Crestron control cards](#). The [CAGE3](#) control cage expansion cage must be installed into the AV4 prior to using control cards. Refer to the [CAGE3 Installation Guide](#) for more information.
- Connect the chassis ground lug to a known earth ground circuit (such as building steel) to ensure that the control system is grounded properly.
- Apply power after all connections have been made.

COM 1-2 Connections

Port	RS-232	RS-422 ¹	RS-485
G	GND	GND	GND ²
TX	TX (from control system)	TX- (from control system)	TX-/RX-
RX	RX (to control system)	RX+ (to control system)	Not used
RTS	RTS (from control system)	TX+ (from control system)	TX+/RX+
CTS	CTS (to control system)	RX- (to control system)	Not used

1. RS-422 transmit and receive are balanced signals that require two lines plus a ground in each direction. RXD+ and TXD+ should idle high (going low at start of data transmission). RXD- and TXD- should idle low (going high at start of data transmission). If necessary, RXD+/RXD- and TXD+/TXD- may be swapped to maintain correct signal levels.
2. A ground terminal connection is recommended but not required.

Connect the Control Subnet

The AV4 has a dedicated Control Subnet that is used for communication between the control system and Crestron Ethernet devices without interference from other traffic on the network.

CAUTION: Do not connect the **CONTROL SUBNET** ports to the LAN. The **CONTROL SUBNET** ports must only be connected to Crestron Ethernet devices.

For more information on using the Control Subnet, refer to [Control Subnet on page 238](#).

CP4 Installation

Use the following procedures to install the CP4.

In the Box

Qty.	Description
1	CP4, 4-Series™ Control System
Additional Items	
2	Bracket, Rack Ear (2032122)
4	Foot, Rubber (2002389)
2	Connector, 3-Pin (2003575)
1	Connector, 4-Pin (2003576)
1	Connector, 5-Pin (2003577)
4	Connector, 8-Pin (2003580)
1	Connector, 9-Pin (2003581)
1	Power Cord, 5 ft, 10 in. (1.78 m) (2042043)
1	Power Pack, 24VDC, 100–240VAC (2045873)

Install the Control System

The control system may be mounted into a rack or placed onto a flat surface.

Rack Mounting

The control system occupies 1U of rack space.

1. Use a #1 Phillips screwdriver to remove the six required screws from the control system assembly (shown in the illustration below).
2. Attach the two included rack ears with the removed screws.
3. Mount the control system into the rack with four mounting screws (not included).

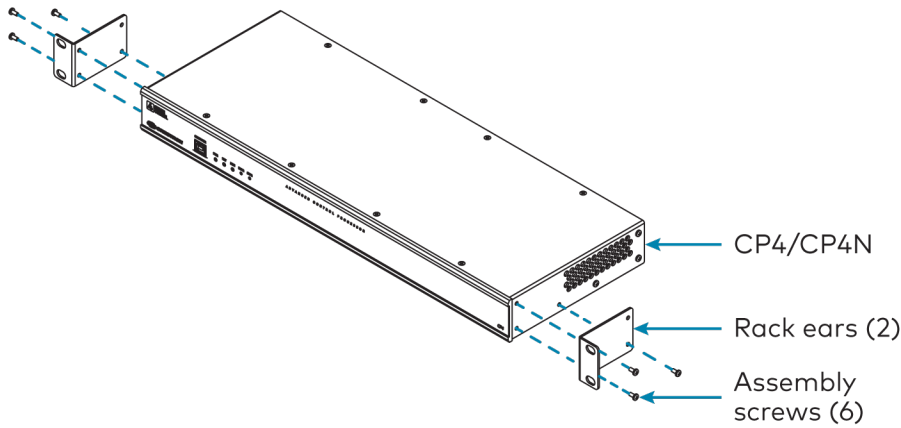

Surface Placement

1. Attach the four adhesive rubber feet near the corners on the underside of the control system.
2. Place onto a flat surface or stack with other equipment.

Connect the Control System

Make all necessary connections to the control system as shown in the following diagram.

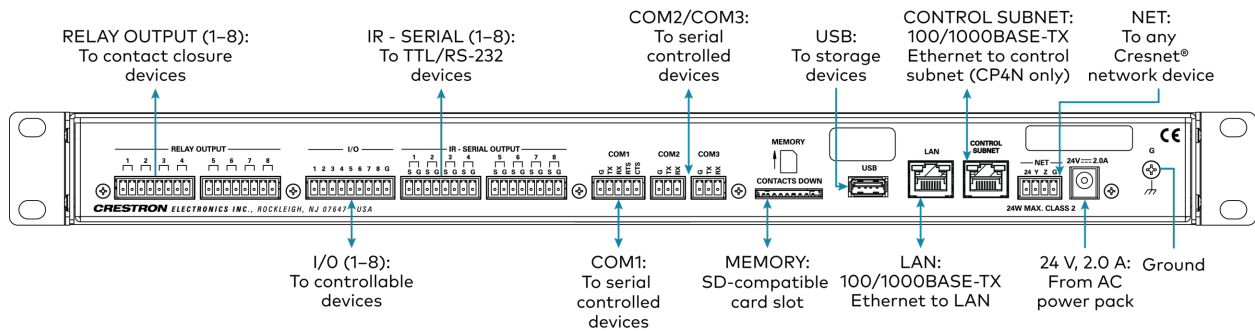

Observe the following when connecting the control system:

- Use Crestron power supplies for Crestron equipment.
- The control system may be powered with the included 24VDC power supply or via Cresnet® network power with the **NET** port.
- Connect the chassis ground lug to a known earth ground circuit (such as building steel) to ensure that the control system is grounded properly.
- Apply power after all connections have been made.

Port	RS-232	RS-422 ¹	RS-485
G	GND	GND	GND ²

Port	RS-232	RS-422 ¹	RS-485
TX	TX (from control system)	TX- (from control system)	TX-/RX-
RX	RX (to control system)	RX+ (to control system)	Not used
RTS	RTS (from control system)	TX+ (from control system)	TX+/RX+
CTS	CTS (to control system)	RX- (to control system)	Not used

1. RS-422 transmit and receive are balanced signals that require two lines plus a ground in each direction. RXD+ and TXD+ should idle high (going low at start of data transmission). RXD- and TXD- should idle low (going high at start of data transmission). If necessary, RXD+/RXD- and TXD+/TXD- may be swapped to maintain correct signal levels.
2. A ground terminal connection is recommended but not required.

CP4N Installation

Use the following procedures to install the CP4N.

In the Box

Qty.	Description
1	CP4N, 4-Series™ Control System
Additional Items	
2	Bracket, Rack Ear (2032122)
4	Foot, Rubber (2002389)
2	Connector, 3-Pin (2003575)
1	Connector, 4-Pin (2003576)
1	Connector, 5-Pin (2003577)
4	Connector, 8-Pin (2003580)
1	Connector, 9-Pin (2003581)
1	Power Cord, 5 ft, 10 in. (1.78 m) (2042043)
1	Power Pack, 24VDC, 100–240VAC (2045873)

Install the Control System

The control system may be mounted into a rack or placed onto a flat surface.

Rack Mounting

The control system occupies 1U of rack space.

1. Use a #1 Phillips screwdriver to remove the six required screws from the control system assembly (shown in the illustration below).
2. Attach the two included rack ears with the removed screws.
3. Mount the control system into the rack with four mounting screws (not included).

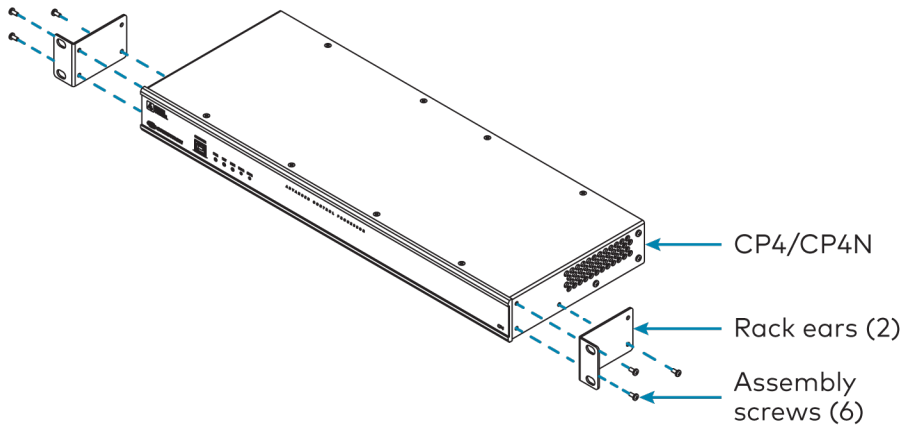

Surface Placement

1. Attach the four adhesive rubber feet near the corners on the underside of the control system.
2. Place onto a flat surface or stack with other equipment.

Connect the Control System

Make all necessary connections to the control system as shown in the following diagram.

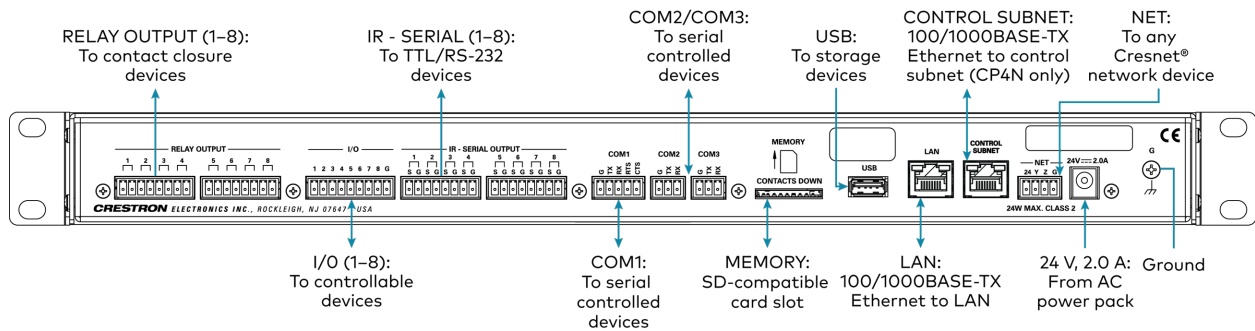

Observe the following when connecting the control system:

- Use Crestron power supplies for Crestron equipment.
- The control system may be powered with the included 24VDC power supply or via Cresnet® network power with the **NET** port.
- Connect the chassis ground lug to a known earth ground circuit (such as building steel) to ensure that the control system is grounded properly.
- Apply power after all connections have been made.

COM 1 Connections

Port	RS-232	RS-422 ¹	RS-485
G	GND	GND	GND ²
TX	TX (from control system)	TX- (from control system)	TX-/RX-
RX	RX (to control system)	RX+ (to control system)	Not used
RTS	RTS (from control system)	TX+ (from control system)	TX+/RX+
CTS	CTS (to control system)	RX- (to control system)	Not used

1. RS-422 transmit and receive are balanced signals that require two lines plus a ground in each direction. RXD+ and TXD+ should idle high (going low at start of data transmission). RXD- and TXD- should idle low (going high at start of data transmission). If necessary, RXD+/RXD- and TXD+/TXD- may be swapped to maintain correct signal levels.
2. A ground terminal connection is recommended but not required.

Connect the Control Subnet

The CP4N has a dedicated Control Subnet that is used for communication between the control system and Crestron Ethernet devices without interference from other traffic on the network.

CAUTION: Do not connect the **CONTROL SUBNET** port to the LAN. The **CONTROL SUBNET** port must only be connected to Crestron Ethernet devices.

For more information on using the Control Subnet, refer to [Control Subnet on page 238](#).

CP4-R Installation

Use the following procedures to install the CP4-R.

In the Box

Qty.	Description
1	CP4-R, 4-Series™ Control System
Additional Items	
2	Bracket, Rack Ear (2032122)
4	Foot, Rubber (2002389)
2	Connector, 3-Pin (2003575)
1	Connector, 4-Pin (2003576)
1	Connector, 5-Pin (2003577)
4	Connector, 8-Pin (2003580)
1	Connector, 9-Pin (2003581)
1	Power Cord, 5 ft, 10 in. (1.78 m) (2042043)
1	Power Pack, 24VDC, 100–240VAC (2045873)
4	IR Emitter with Terminal Block Connector (4500152)

Install the Control System

The control system may be mounted into a rack or onto a flat surface.

Rack Mounting

The control system occupies 1U of rack space.

1. Use a #1 Phillips screwdriver to remove the six required screws from the control system assembly (shown in the illustration below).
2. Attach the two included rack ears with the removed screws.
3. Mount the control system into the rack with four mounting screws (not included).

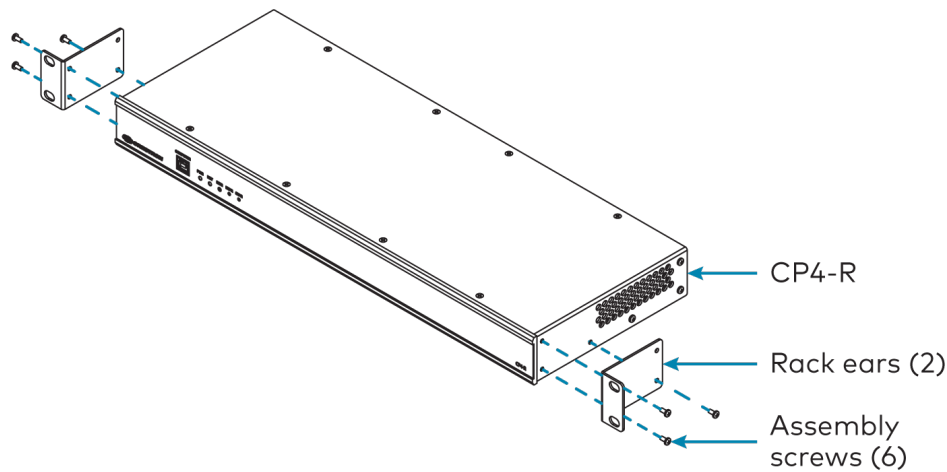

Surface Placement

1. Attach the four adhesive rubber feet near the corners on the underside of the control system.
2. Place onto a flat surface or stack with other equipment.

Connect the Control System

Make all necessary connections to the control system as shown in the following diagram.

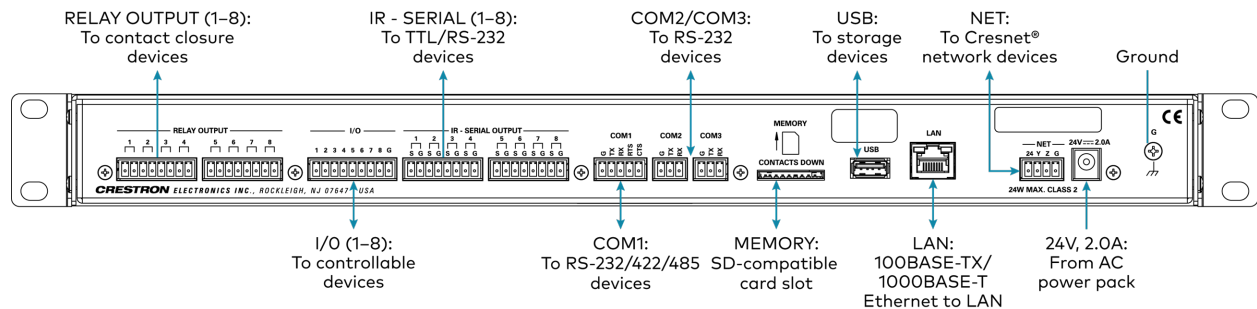

NOTE: Ensure that the included SD card is seated fully in the **MEMORY** slot prior to powering on the control system.

Observe the following when connecting the control system:

- Use Crestron power supplies for Crestron equipment.
- The control system may be powered with the included 24VDC power supply or via Cresnet® network power with the **NET** port.
- Connect the chassis ground lug to a known earth ground circuit (such as building steel) to ensure that the control system is grounded properly.
- Apply power after all connections have been made.

COM 1 Connections

Port	RS-232	RS-422 ¹	RS-485
G	GND	GND	GND ²
TX	TX (from control system)	TX- (from control system)	TX-/RX-
RX	RX (to control system)	RX+ (to control system)	Not used
RTS	RTS (from control system)	TX+ (from control system)	TX+/RX+
CTS	CTS (to control system)	RX- (to control system)	Not used

1. RS-422 transmit and receive are balanced signals that require two lines plus a ground in each direction. RXD+ and TXD+ should idle high (going low at start of data transmission). RXD- and TXD- should idle low (going high at start of data transmission). If necessary, RXD+/RXD- and TXD+/TXD- may be swapped to maintain correct signal levels.
2. A ground terminal connection is recommended but not required.

Install IR Emitters (Optional)

The control system ships with four IR emitters, which adhere to the IR sensor window of a display, optical disc player, or any other IR-controlled device. Each IR emitter has a 2-pin terminal block that connects to the **IR - SERIAL** port on the control system, providing a one-way IR control interface to the connected device.

NOTE: The white-traced wire on the IR emitter is positive and connects to one of the **IR - SERIAL** port pins labeled "S."

Position the IR Emitter

The IR emitter works best for most devices when positioned directly over the device IR sensor. However, operation is more consistent for some devices when the IR emitter is offset one or two inches from the device IR sensor.

To position the IR emitter, send commands from the control system while moving the IR emitter around the front panel of the device. When operation is consistent and reliable, attach the IR emitter using the procedure described in [Attach the IR Emitter on page 117](#).

Attach the IR Mask

Attach the IR mask (packaged with the IR emitter) when two or more identical devices are being controlled using IR. The IR mask prevents stray IR output from controlling another device accidentally.

Place the IR mask over the IR emitter shell as shown in the following illustration. Do not remove the clear adhesive strips from the IR emitter shell or the IR mask.

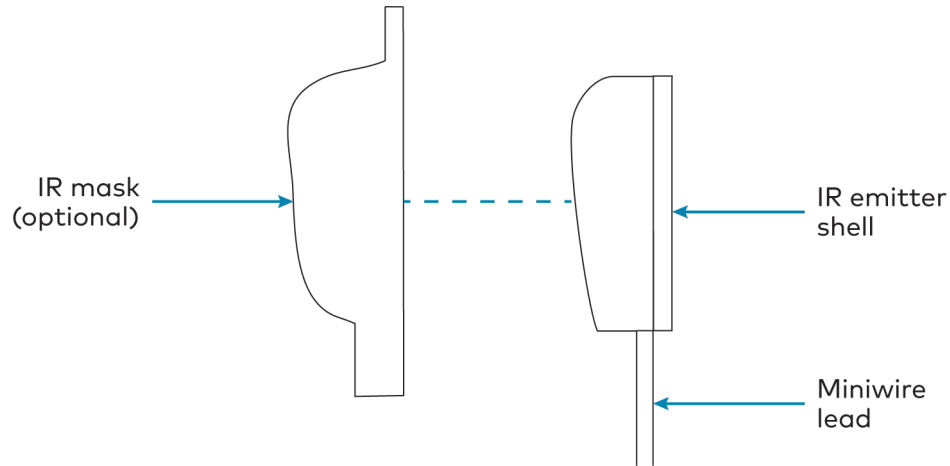

Attach the IR Emitter

1. Peel off the clear adhesive strip on the back of the IR emitter shell and the IR mask (if attached).
2. Affix the IR emitter by pressing it firmly to the desired location on the front panel of the controlled device.

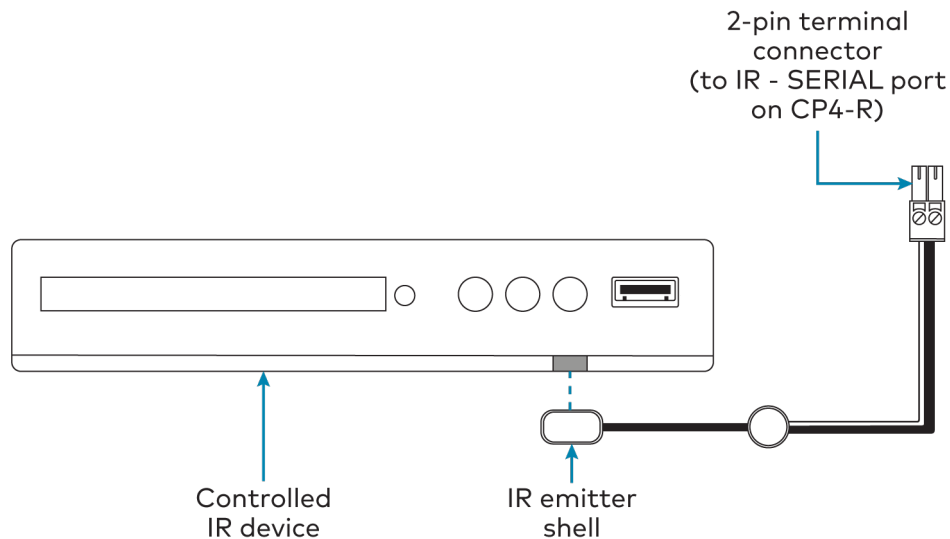

If the IR emitter must be removed and repositioned for any reason, it may be necessary to replace the adhesive on the IR emitter with a new piece of two-sided tape.

NOTE: The IR emitter is a pure infrared emitter that does not emit any visible light. To test that the IR emitter is working properly, trigger an IR command from the control system. Then, use a digital camera device (such as a smart phone) to record a video of the IR emitter while it is being triggered. If the IR signal is visible in the video during playback, the IR emitter is working properly.

DIN-AP4 Installation

Use the following procedures to install the DIN-AP4.

In the Box

Qty.	Description
1	DIN-AP4, 4-Series™ DIN Rail Control System
Additional Items	
1	Connector, 2-Pin (2020549)
2	Connector, 4-Pin (2020555)
2	Connector, 5-Pin (2020548)
2	Connector, 8-Pin (2020551)
1	Connector, 9-Pin (2020552)

Mount the Control System

The control system can be mounted onto a standard DIN rail (not included).

Observe the following prior to mounting the control system:

- Use in an electrical panel with DIN rail mounting provisions.
- Mount in a well-ventilated area.
- Do not block the venting holes.

CAUTION: To prevent overheating, do not operate the control system in an area that exceeds the environmental temperature range (41 to 113°F or 5 to 45°C) for this device.

To mount the control system:

1. Hang the control system on the top of the DIN rail.
2. Align the bottom of the control system with the DIN rail, then snap the control system into place.

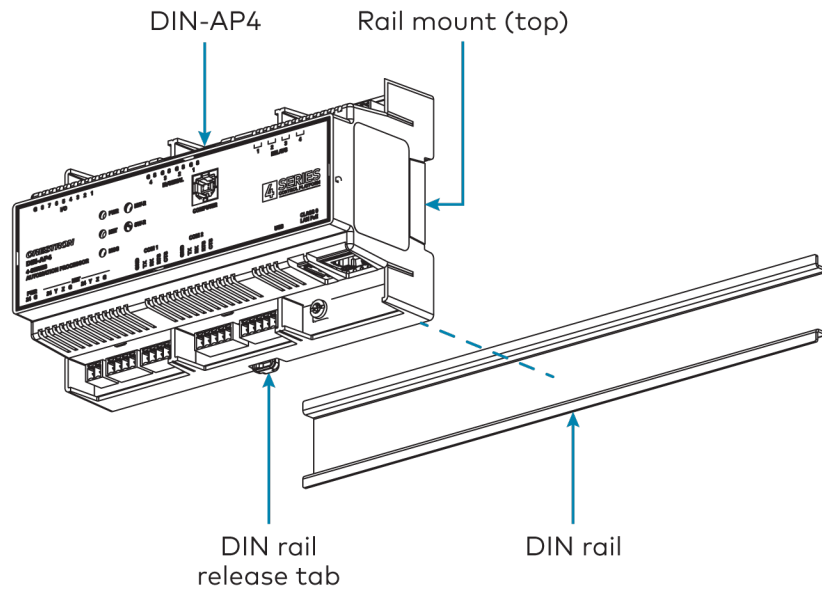

To remove the control system from the DIN rail:

1. Turn off the power to the control system.
 2. Remove all connections from the control system.
 3. Use a small, flat-head screwdriver to pull the DIN rail release tab down.
 4. Tilt the bottom of the control system away from the bottom of the DIN rail, then remove the control system.
1. Attach the four adhesive rubber feet near the corners on the underside of the control system.
 2. Place onto a flat surface or stack with other equipment.

Use four mounting screws (not provided) to mount the control system to a flat surface such as a wall or under a table. The control system can also be mounted behind a flat panel display or similar equipment.

Connect the Control System

Make all necessary connections to the control system as shown in the following diagrams.

Top Panel Connections

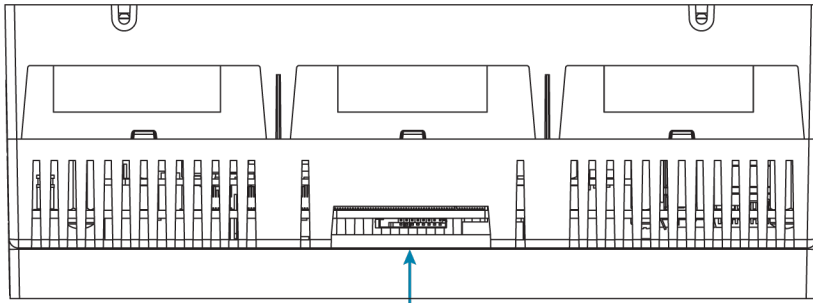

Memory:
For SD or
SDHC cards

Bottom Panel Connections

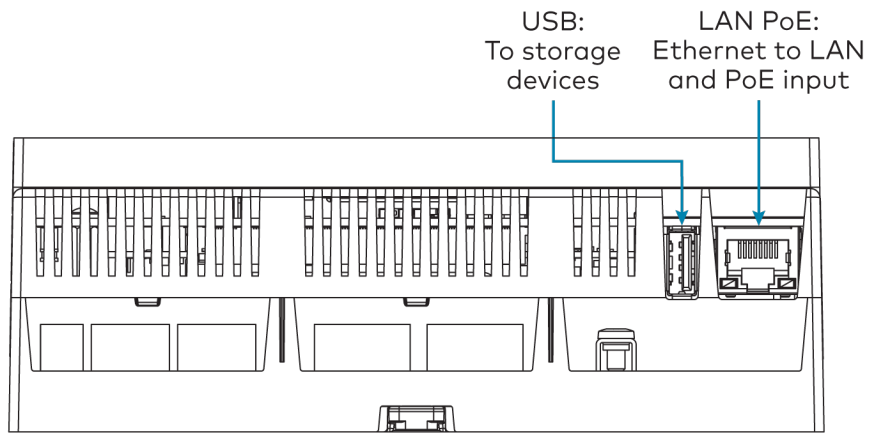

USB:
To storage
devices

LAN PoE:
Ethernet to LAN
and PoE input

Front Panel Connections

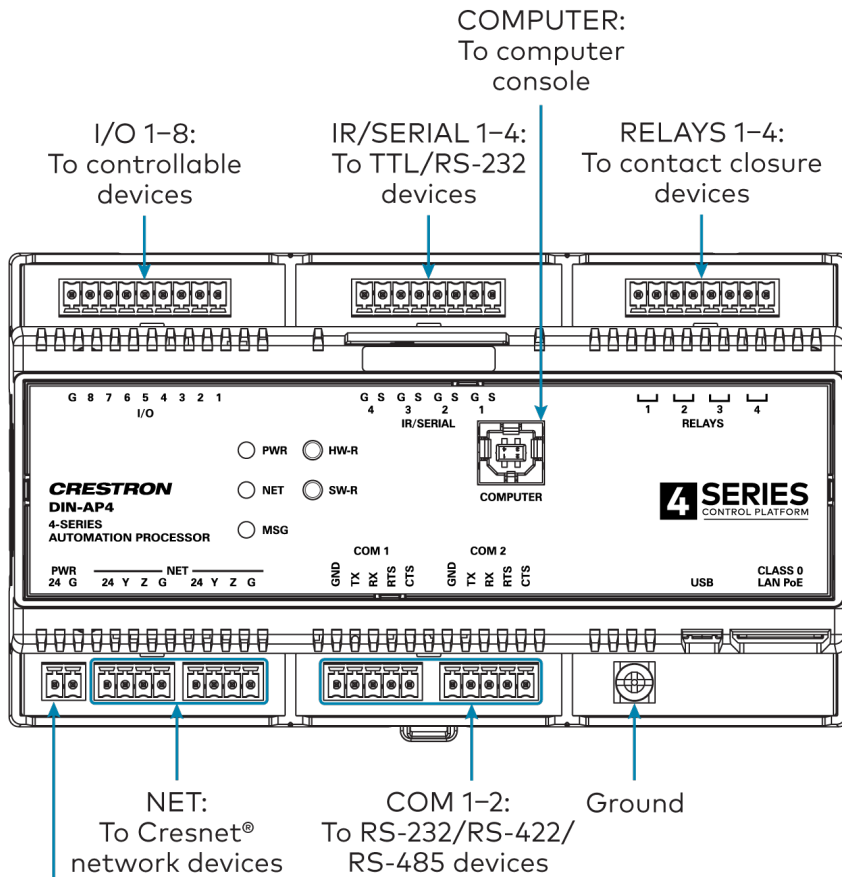

PWR:
From 24 VDC
power pack
(not included)

Observe the following when connecting the control system:

NOTE: To comply with the European Directive (CE), Crestron recommends using shielded CAT5e cable as a minimum for PoE power.

- Use Crestron power supplies for Crestron equipment.
- Power may be provided to the control system by a 24VDC power supply ([DIN-PWS30-277](#), not included) via the **PWR** port or a single Ethernet cable via the **LAN PoE** port. A Crestron PoE (Power over Ethernet) power supply, such as the [PWE-4803RU](#), or a PoE-capable network switch is recommended for Ethernet power (both not included).
- Connect the chassis ground lug to a known earth ground circuit (such as building steel) to ensure that the control system is grounded properly.
- Apply power after all connections have been made.

COM 1–2 Connections

Port	RS-232	RS-422 ¹	RS-485
G	GND	GND	GND ²
TX	TX (from control system)	TX- (from control system)	TX-/RX-
RX	RX (to control system)	RX+ (to control system)	Not used
RTS	RTS (from control system)	TX+ (from control system)	TX+/RX+
CTS	CTS (to control system)	RX- (to control system)	Not used

1. RS-422 transmit and receive are balanced signals that require two lines plus a ground in each direction. RXD+ and TXD+ should idle high (going low at start of data transmission). RXD- and TXD- should idle low (going high at start of data transmission). If necessary, RXD+/RXD- and TXD+/TXD- may be swapped to maintain correct signal levels.
2. A ground terminal connection is recommended but not required.

DIN-AP4-R Installation

Use the following procedures to install the DIN-AP4-R.

In the Box

Qty.	Description
1	DIN-AP4-R, 4-Series™ DIN Rail Control System
Additional Items	
1	Connector, 2-Pin (2020549)
2	Connector, 4-Pin (2020555)
2	Connector, 5-Pin (2020548)
2	Connector, 8-Pin (2020551)
1	Connector, 9-Pin (2020552)

Mount the Control System

The control system can be mounted onto a standard DIN rail (not included).

Observe the following prior to mounting the control system:

- Use in an electrical panel with DIN rail mounting provisions.
- Mount in a well-ventilated area.
- Do not block the venting holes.

CAUTION: To prevent overheating, do not operate the control system in an area that exceeds the environmental temperature range (41 to 113°F or 5 to 45°C) for this device.

To mount the control system:

1. Hang the control system on the top of the DIN rail.
2. Align the bottom of the control system with the DIN rail, then snap the control system into place.

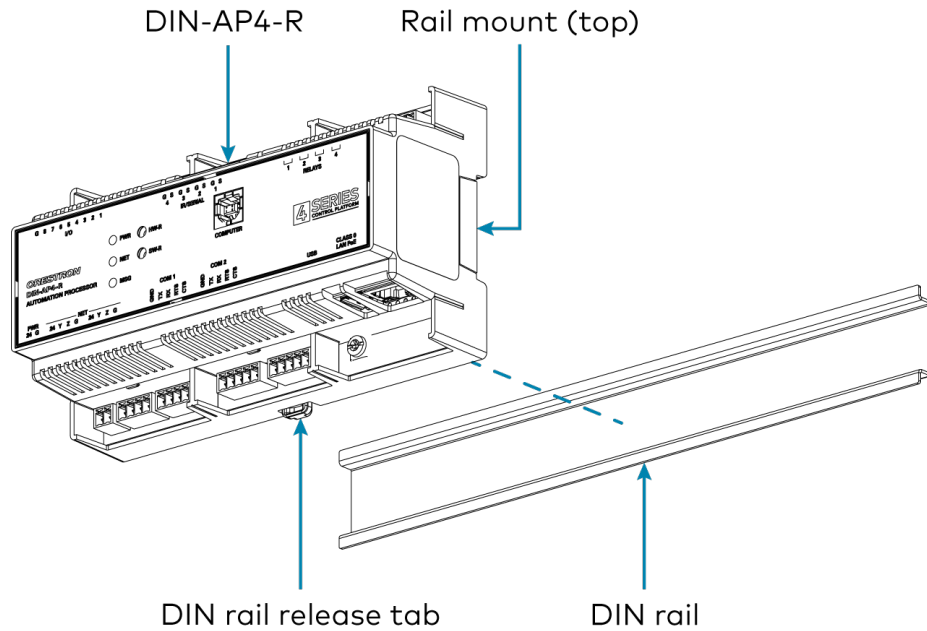

To remove the control system from the DIN rail:

1. Turn off the power to the control system.
 2. Remove all connections from the control system.
 3. Use a small, flat-head screwdriver to pull the DIN rail release tab down.
 4. Tilt the bottom of the control system away from the bottom of the DIN rail, then remove the control system.
1. Attach the four adhesive rubber feet near the corners on the underside of the control system.
 2. Place onto a flat surface or stack with other equipment.

Use four mounting screws (not provided) to mount the control system to a flat surface such as a wall or under a table. The control system can also be mounted behind a flat panel display or similar equipment.

Connect the Control System

Make all necessary connections to the control system as shown in the following diagrams.

Top Panel Connections

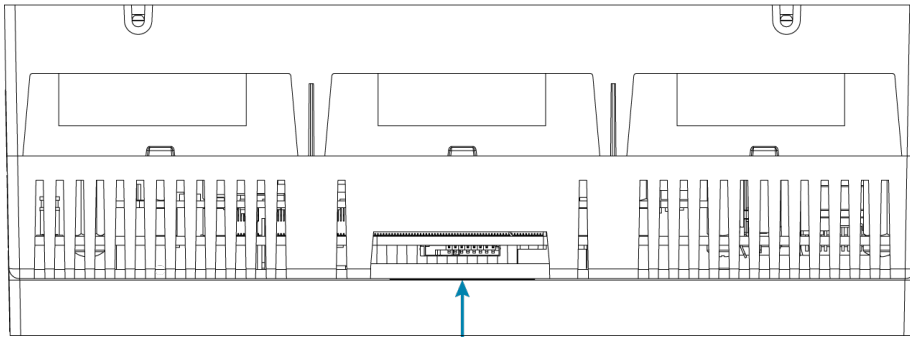

Memory:
For microSD® cards

Bottom Panel Connections

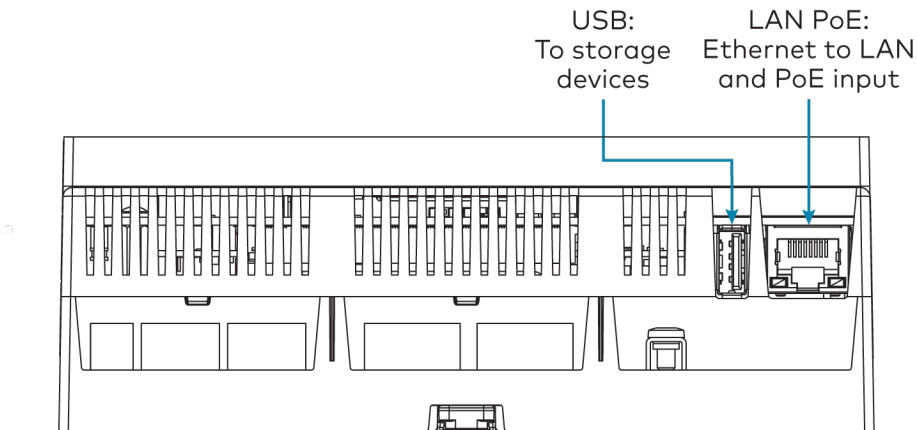

USB:
To storage
devices

LAN PoE:
Ethernet to LAN
and PoE input

Front Panel Connections

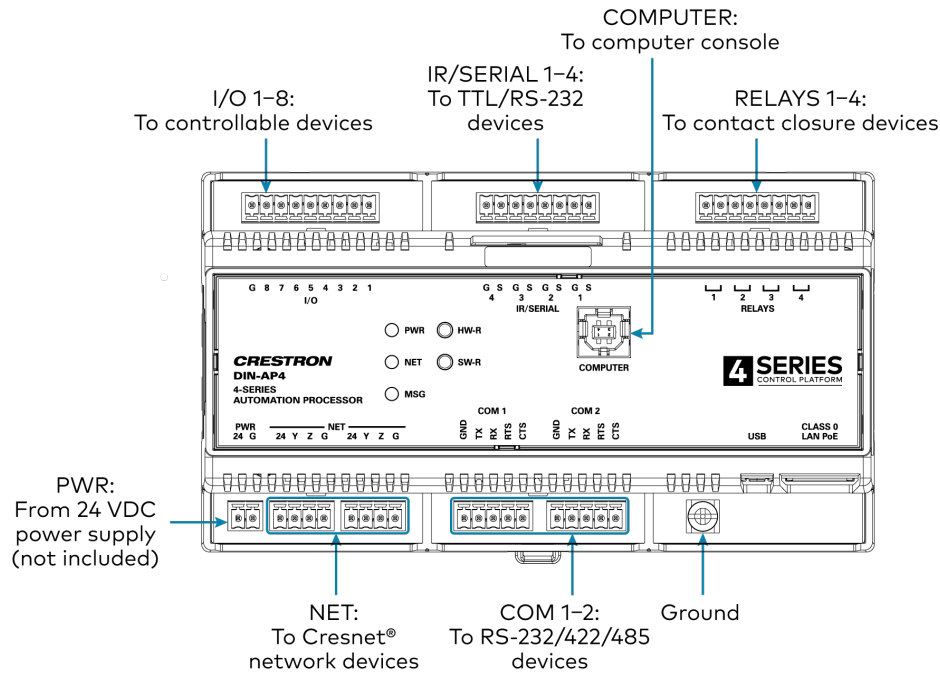

NOTE: Ensure that the included SD card is seated fully in the **MEMORY** slot prior to powering on the control system.

Observe the following when connecting the control system:

NOTE: To comply with the European Directive (CE), Crestron recommends using shielded CAT5e cable as a minimum for PoE power.

- Use Crestron power supplies for Crestron equipment.
- Power may be provided to the control system by a 24VDC power supply ([DIN-PWS30-277](#), not included) via the **PWR** port or a single Ethernet cable via the **LAN PoE** port. A Crestron PoE (Power over Ethernet) power supply, such as the [PWE-4803RU](#), or a PoE-capable network switch is recommended for Ethernet power (both not included).
- Connect the chassis ground lug to a known earth ground circuit (such as building steel) to ensure that the control system is grounded properly.
- Apply power after all connections have been made.

COM 1-2 Connections

Port	RS-232	RS-422 ¹	RS-485
G	GND	GND	GND ²

Port	RS-232	RS-422 ¹	RS-485
TX	TX (from control system)	TX- (from control system)	TX-/RX-
RX	RX (to control system)	RX+ (to control system)	Not used
RTS	RTS (from control system)	TX+ (from control system)	TX+/RX+
CTS	CTS (to control system)	RX- (to control system)	Not used

1. RS-422 transmit and receive are balanced signals that require two lines plus a ground in each direction. RXD+ and TXD+ should idle high (going low at start of data transmission). RXD- and TXD- should idle low (going high at start of data transmission). If necessary, RXD+/RXD- and TXD+/TXD- may be swapped to maintain correct signal levels.
2. A ground terminal connection is recommended but not required.

MC4 Installation

Use the following procedures to install the MC4.

In the Box

Qty.	Description
1	MC4, 4-Series™ Control System
Additional Items	
1	Rack Ear, Left (2053897)
1	Rack Ear, Right (2053896)
4	Nut, 10-32 (2004889)
1	Antenna, Dual Band, 2.4/5.8 GHz (2052945)
1	Cable, CAT5e, 5 ft (1.52 m) (2022311)
2	Connector, 3-Pin (2003575)
4	Connector, 4-Pin (2003576)

Install the Control System

The control system may be mounted into a rack or onto a flat surface.

Rack Mounting

The control system occupies 1U of rack space with the provided rack ears. The control system can also be mounted to a single rack rail using its integrated flanges.

1. Attach the rack ears to the device:
 - a. Insert the two threaded posts on the left rack ear up and into the front opening in the left mounting flange of the control system. Repeat this step for the right rack ear.
 - b. Attach the four provided nuts to the threaded posts to secure the rack ears to the control system.

Refer to the following image for rack ear placement.

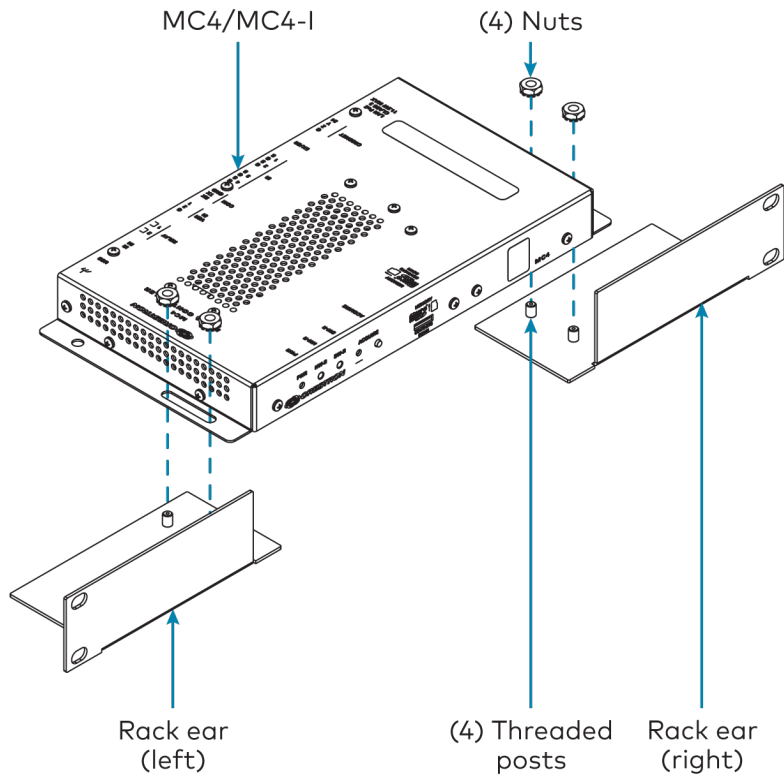

- Secure the control system to the rack rails using four rack mounting screws (not provided).

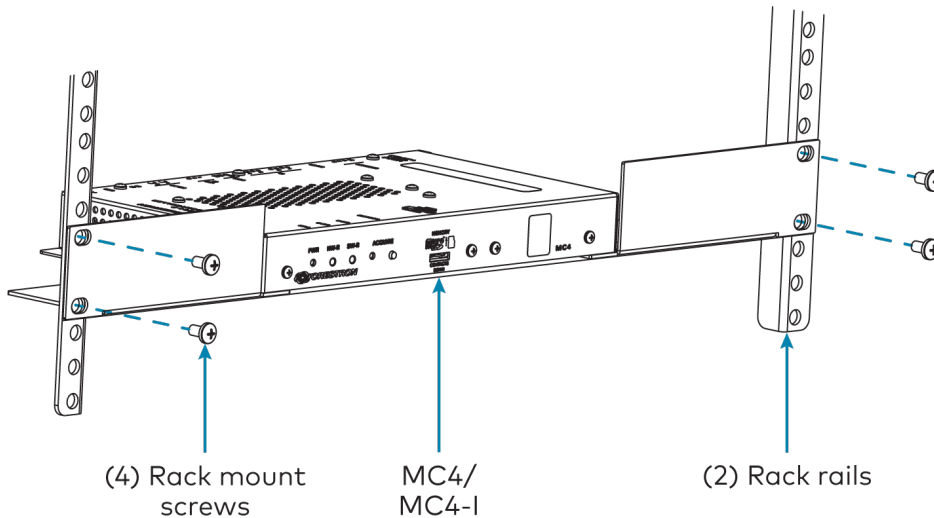

Surface Mounting

Use four mounting screws (not provided) to mount the control system to a flat surface such as a wall or under a table. The control system can also be mounted behind a flat panel display or similar equipment.

Connect the Control System

Make all necessary connections to the control system as shown in the following diagrams.

Front Panel Connections

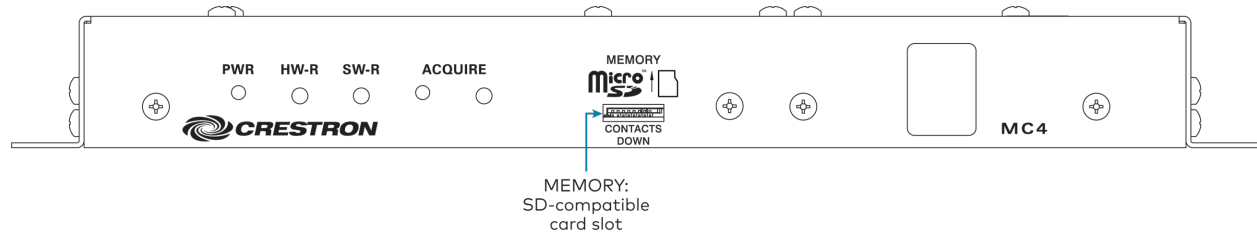

Rear Panel Connections

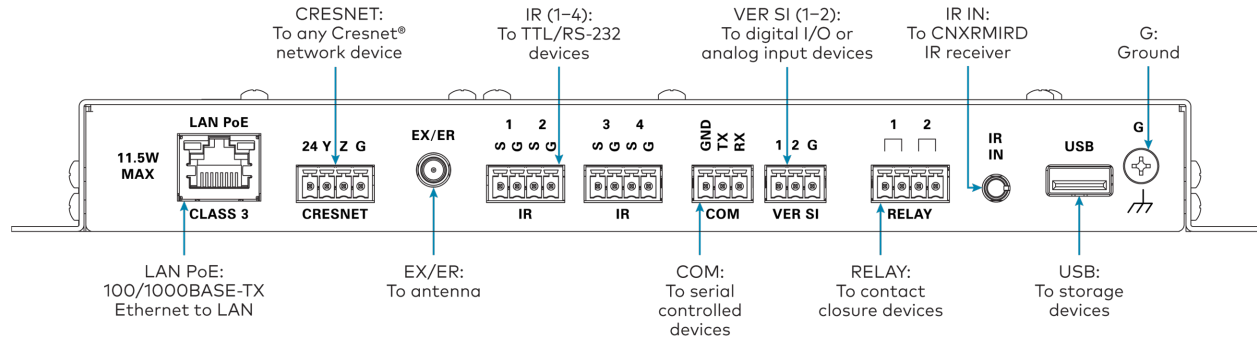

Observe the following when connecting the control system:

- Use Crestron power supplies for Crestron equipment.
- The control system is powered over PoE (Power over Ethernet) via a Crestron PoE injector ([PWE-4803RU](#)) or a Crestron PoE switch ([CEN-SW-POE-5](#) or [CEN-SWPOE-16](#)). All PoE equipment is sold separately.
- The included cables may not be extended.
- Mount the included antenna per the guidelines described in [Mount the Antenna on page 131](#).
- Connect the chassis ground lug to a known earth ground circuit (such as building steel) to ensure that the control system is grounded properly.
- Apply power after all connections have been made.

Mount the Antenna

The included antenna should be placed in a location that maximizes signal strength and limits impedance. Refer to the [Best Practices for Installation and Setup of Crestron RF Products](#).

MC4-I Installation

Use the following procedures to install the MC4-I.

In the Box

Qty.	Description
1	MC4-I, 4-Series™ Control System, International
Additional Items	
1	Rack Ear, Left (2053897)
1	Rack Ear, Right (2053896)
4	Nut, 10-32 (2004889)
1	Antenna, Dual Band, 2.4/5.8 GHz (2052945)
1	Cable, CAT5e, 5 ft (1.52 m) (2022311)
2	Connector, 3-Pin (2003575)
4	Connector, 4-Pin (2003576)

Install the Control System

The control system may be mounted into a rack or onto a flat surface.

Rack Mounting

The control system occupies 1U of rack space with the provided rack ears. The control system can also be mounted to a single rack rail using its integrated flanges.

1. Attach the rack ears to the device:
 - a. Insert the two threaded posts on the left rack ear up and into the front opening in the left mounting flange of the control system. Repeat this step for the right rack ear.
 - b. Attach the four provided nuts to the threaded posts to secure the rack ears to the control system.

Refer to the following image for rack ear placement.

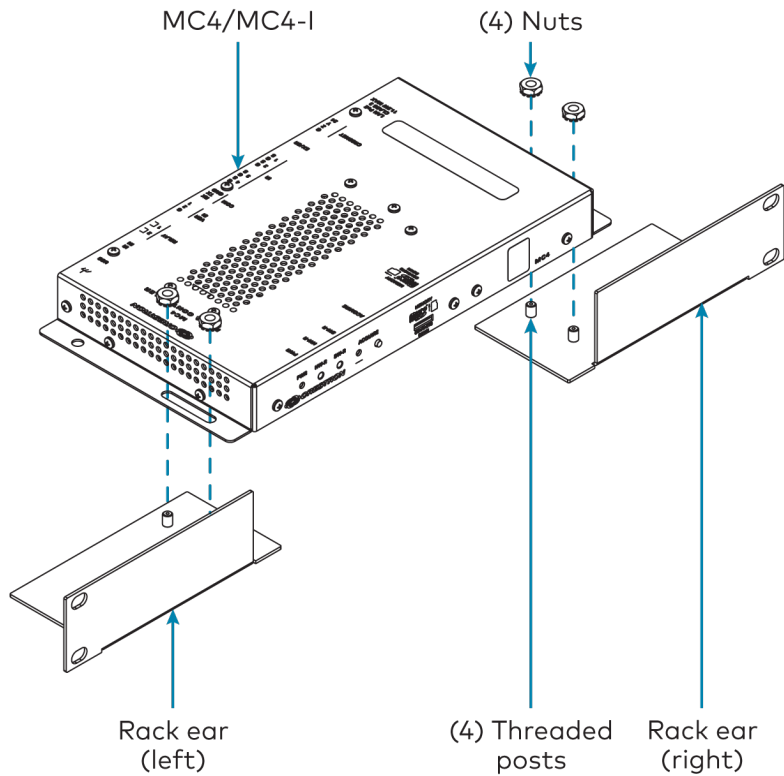

- Secure the control system to the rack rails using four rack mounting screws (not provided).

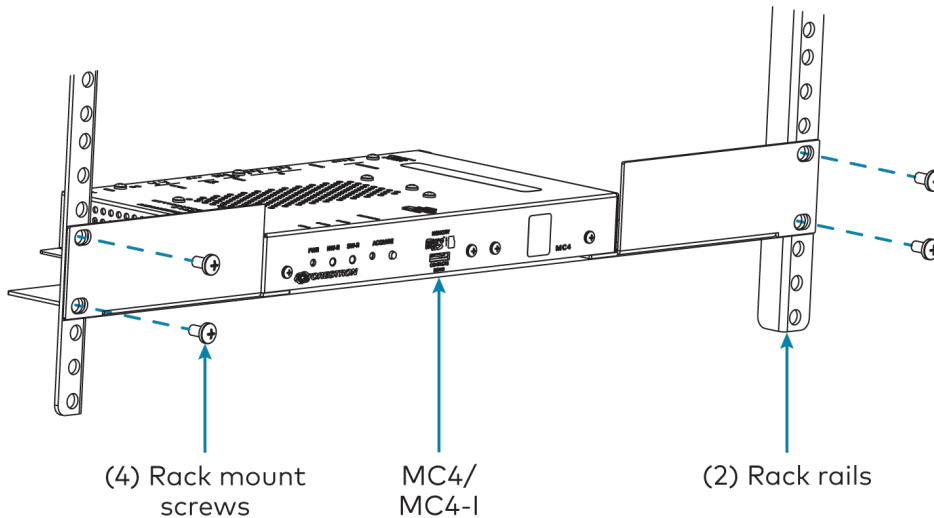

Surface Mounting

Use four mounting screws (not provided) to mount the control system to a flat surface such as a wall or under a table. The control system can also be mounted behind a flat panel display or similar equipment.

Connect the Control System

Make all necessary connections to the control system as shown in the following diagrams.

Front Panel Connections

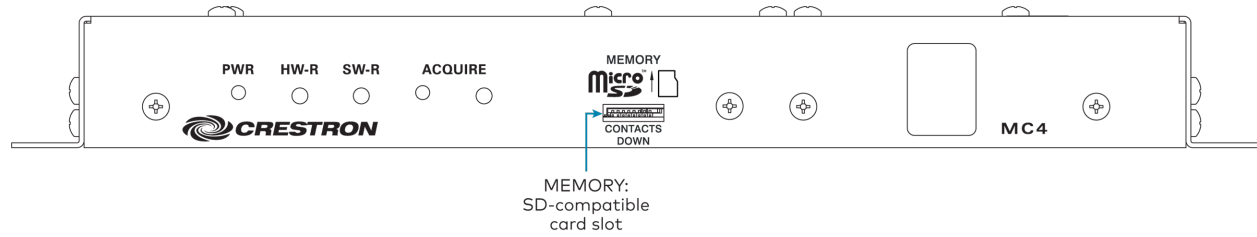

Rear Panel Connections

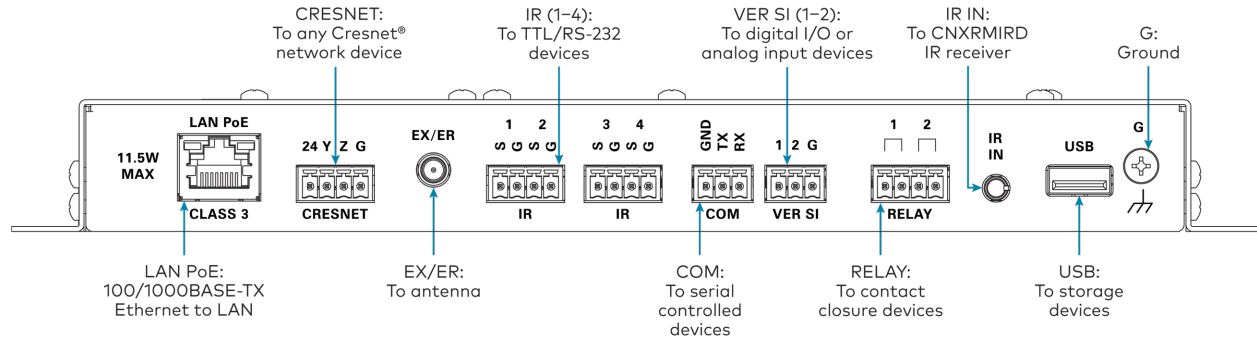

Observe the following when connecting the control system:

- Use Crestron power supplies for Crestron equipment.
- The control system is powered over PoE (Power over Ethernet) via a Crestron PoE injector ([PWE-4803RU](#)) or a Crestron PoE switch ([CEN-SW-POE-5](#) or [CEN-SWPOE-16](#)). All PoE equipment is sold separately.
- The included cables may not be extended.
- Mount the included antenna per the guidelines described in [Mount the Antenna on page 134](#).
- Connect the chassis ground lug to a known earth ground circuit (such as building steel) to ensure that the control system is grounded properly.
- Apply power after all connections have been made.

Mount the Antenna

The included antenna should be placed in a location that maximizes signal strength and limits impedance. Refer to the [Best Practices for Installation and Setup of Crestron RF Products](#).

MC4-R Installation

Use the following procedures to install the MC4-R.

In the Box

Qty.	Description
1	MC4-R, 4-Series™ Control System
Additional Items	
1	Rack Ear, Left (2053897)
1	Rack Ear, Right (2053896)
4	Nut, 10-32 (2004889)
1	Antenna, Dual Band, 2.4/5.8 GHz (2052945)
1	Cable, CAT5e, 5 ft (1.52 m) (2022311)
2	Connector, 3-Pin (2003575)
4	Connector, 4-Pin (2003576)
4	IR Emitter with Terminal Block Connector (4500152)

Install the Control System

The control system may be mounted into a rack or onto a flat surface.

Rack Mounting

The control system occupies 1U of rack space with the provided rack ears. The control system can also be mounted to a single rack rail using its integrated flanges.

1. Attach the rack ears to the device:
 - a. Insert the two threaded posts on the left rack ear up and into the front opening in the left mounting flange of the control system. Repeat this step for the right rack ear.
 - b. Attach the four provided nuts to the threaded posts to secure the rack ears to the control system.

Refer to the following image for rack ear placement.

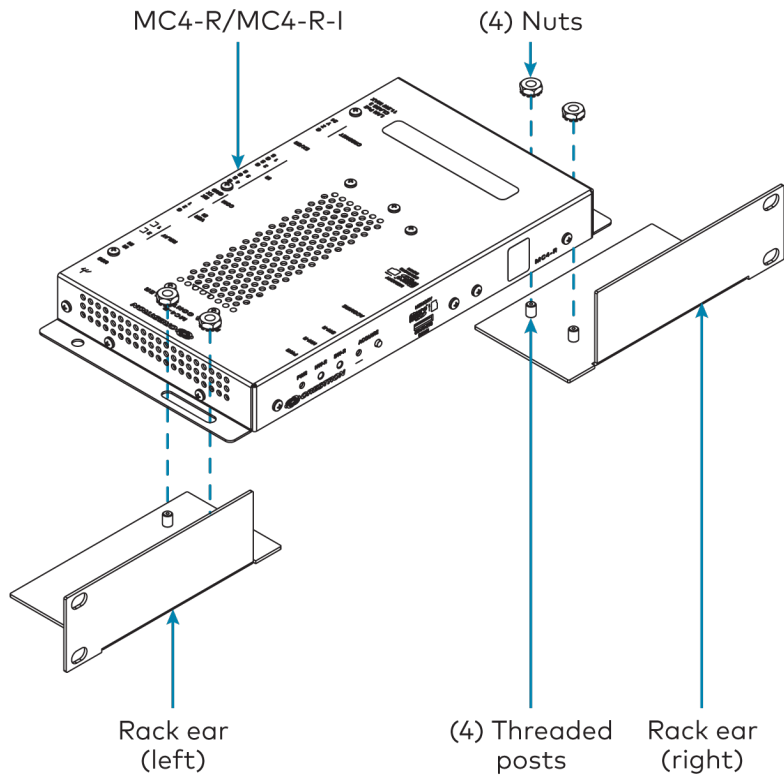

2. Secure the control system to the rack rails using four rack mounting screws (not provided).

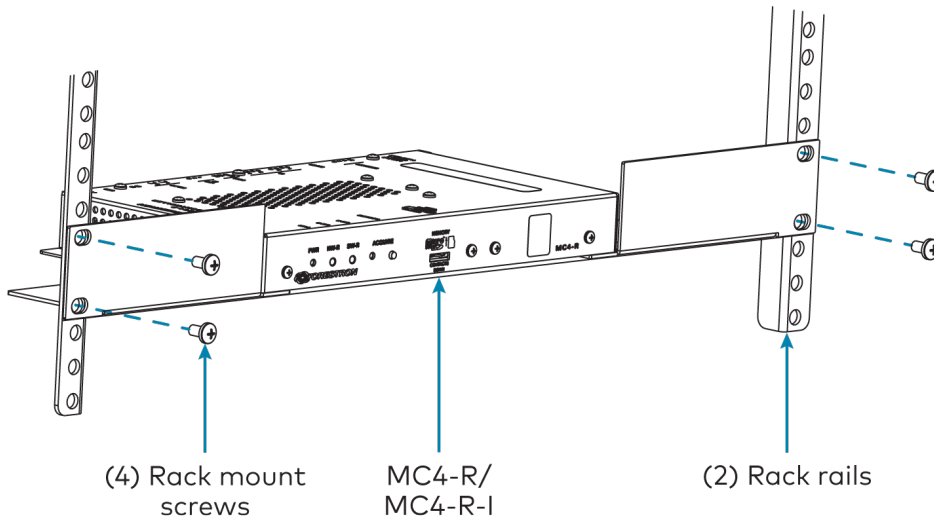

Surface Mounting

Use four mounting screws (not provided) to mount the control system to a flat surface such as a wall or under a table. The control system can also be mounted behind a flat panel display or similar equipment.

Connect the Control System

Make all necessary connections to the control system as shown in the following diagrams.

Front Panel Connections

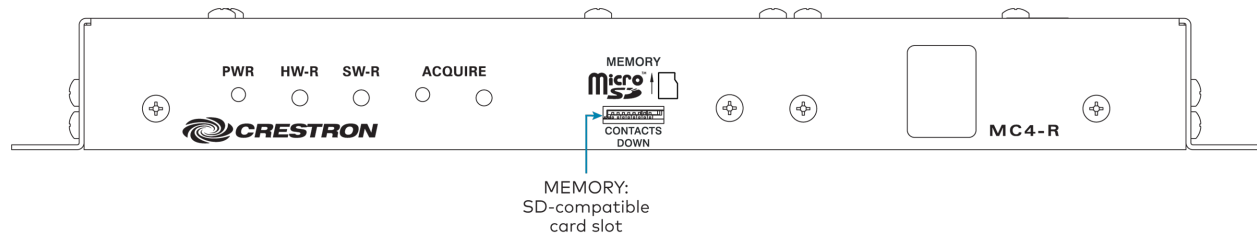

Rear Panel Connections

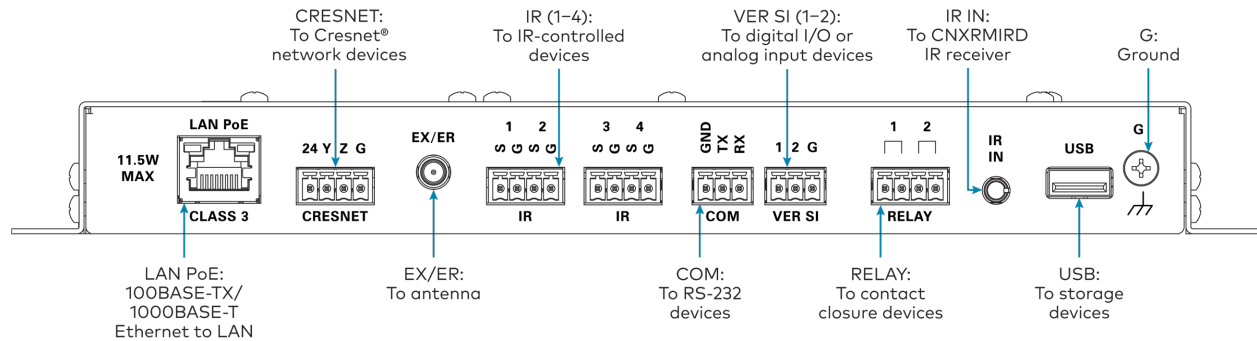

NOTE: Ensure that the included SD card is seated fully in the **MEMORY** slot prior to powering on the control system.

Observe the following when connecting the control system:

- Use Crestron power supplies for Crestron equipment.
- The control system is powered over PoE (Power over Ethernet) via a Crestron PoE injector ([PWE-4803RU](#)) or a Crestron PoE switch ([CEN-SW-POE-5](#) or [CEN-SWPOE-16](#)). All PoE equipment is sold separately.
- The included cables may not be extended.
- Mount the included antenna per the guidelines described in [Mount the Antenna on page 137](#).
- Connect the chassis ground lug to a known earth ground circuit (such as building steel) to ensure that the control system is grounded properly.
- Apply power after all connections have been made.

Mount the Antenna

The included antenna should be placed in a location that maximizes signal strength and limits impedance. Refer to the [Best Practices for Installation and Setup of Crestron RF Products](#).

Install IR Emitters (Optional)

The control system ships with four IR emitters, which adhere to the IR sensor window of a display, optical disc player, or any other IR-controlled device. Each IR emitter has a 2-pin terminal block that connects to the **IR - SERIAL** port on the control system, providing a one-way IR control interface to the connected device.

NOTE: The white-traced wire on the IR emitter is positive and connects to one of the **IR - SERIAL** port pins labeled "S."

Position the IR Emitter

The IR emitter works best for most devices when positioned directly over the device IR sensor. However, operation is more consistent for some devices when the IR emitter is offset one or two inches from the device IR sensor.

To position the IR emitter, send commands from the control system while moving the IR emitter around the front panel of the device. When operation is consistent and reliable, attach the IR emitter using the procedure described in [Attach the IR Emitter on page 117](#).

Attach the IR Mask

Attach the IR mask (packaged with the IR emitter) when two or more identical devices are being controlled using IR. The IR mask prevents stray IR output from controlling another device accidentally.

Place the IR mask over the IR emitter shell as shown in the following illustration. Do not remove the clear adhesive strips from the IR emitter shell or the IR mask.

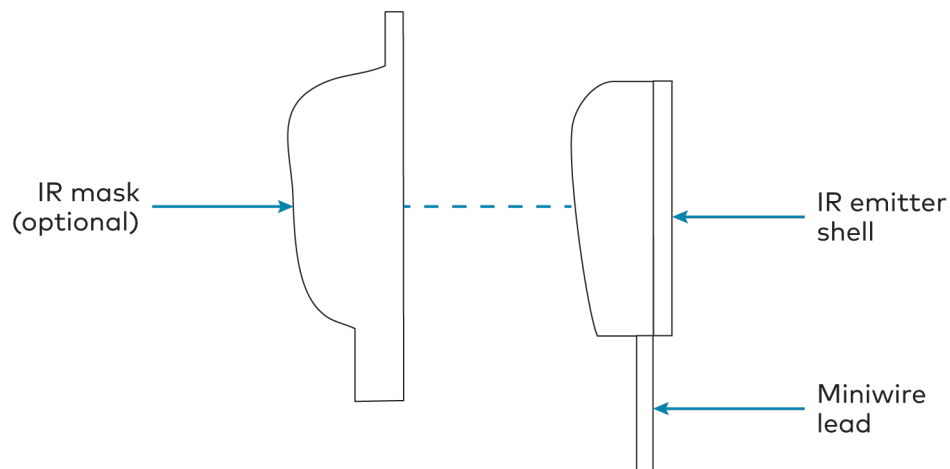

Attach the IR Emitter

1. Peel off the clear adhesive strip on the back of the IR emitter shell and the IR mask (if attached).

2. Affix the IR emitter by pressing it firmly to the desired location on the front panel of the controlled device.

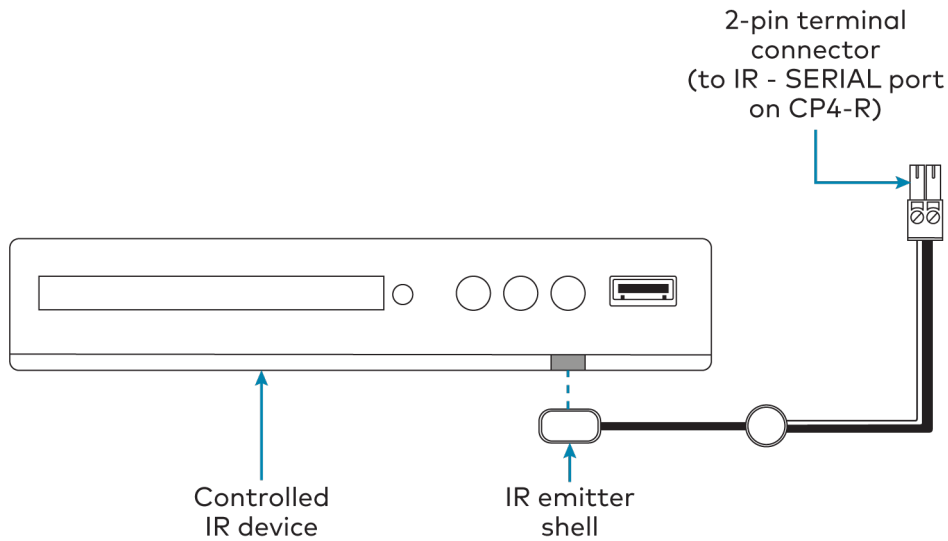

If the IR emitter must be removed and repositioned for any reason, it may be necessary to replace the adhesive on the IR emitter with a new piece of two-sided tape.

NOTE: The IR emitter is a pure infrared emitter that does not emit any visible light. To test that the IR emitter is working properly, trigger an IR command from the control system. Then, use a digital camera device (such as a smart phone) to record a video of the IR emitter while it is being triggered. If the IR signal is visible in the video during playback, the IR emitter is working properly.

MC4-R-I Installation

Use the following procedures to install the MC4-R-I.

In the Box

Qty.	Description
1	MC4-R-I, 4-Series™ Control System, International
Additional Items	
1	Rack Ear, Left (2053897)
1	Rack Ear, Right (2053896)
4	Nut, 10-32 (2004889)
1	Antenna, Dual Band, 2.4/5.8 GHz (2052945)
1	Cable, CAT5e, 5 ft (1.52 m) (2022311)
2	Connector, 3-Pin (2003575)
4	Connector, 4-Pin (2003576)
4	IR Emitter with Terminal Block Connector (4500152)

Install the Control System

The control system may be mounted into a rack or onto a flat surface.

Rack Mounting

The control system occupies 1U of rack space with the provided rack ears. The control system can also be mounted to a single rack rail using its integrated flanges.

1. Attach the rack ears to the device:
 - a. Insert the two threaded posts on the left rack ear up and into the front opening in the left mounting flange of the control system. Repeat this step for the right rack ear.
 - b. Attach the four provided nuts to the threaded posts to secure the rack ears to the control system.

Refer to the following image for rack ear placement.

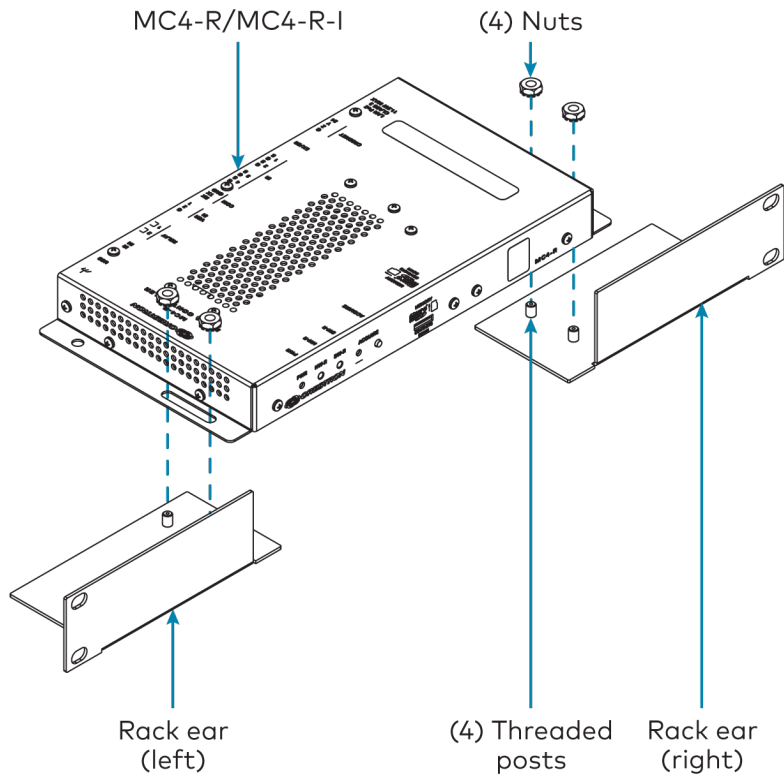

- Secure the control system to the rack rails using four rack mounting screws (not provided).

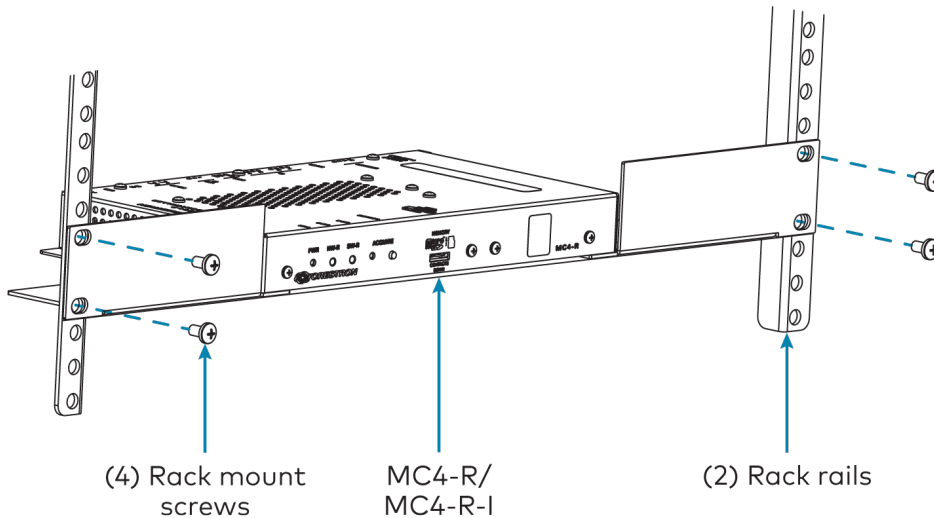

Surface Mounting

Use four mounting screws (not provided) to mount the control system to a flat surface such as a wall or under a table. The control system can also be mounted behind a flat panel display or similar equipment.

Connect the Control System

Make all necessary connections to the control system as shown in the following diagrams.

Front Panel Connections

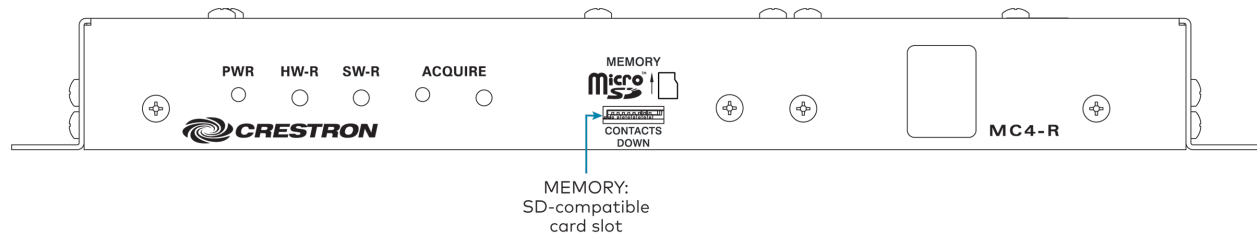

Rear Panel Connections

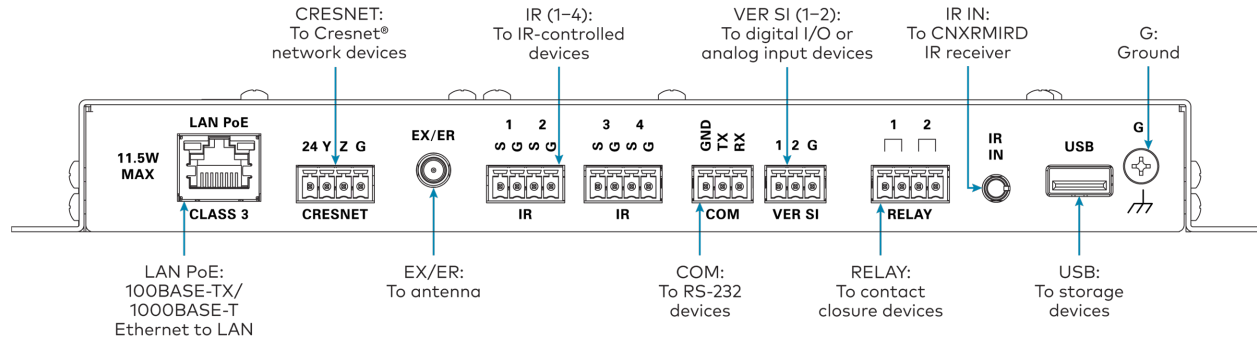

NOTE: Ensure that the included SD card is seated fully in the **MEMORY** slot prior to powering on the control system.

Observe the following when connecting the control system:

- Use Crestron power supplies for Crestron equipment.
- The control system is powered over PoE (Power over Ethernet) via a Crestron PoE injector ([PWE-4803RU](#)) or a Crestron PoE switch ([CEN-SW-POE-5](#) or [CEN-SWPOE-16](#)). All PoE equipment is sold separately.
- The included cables may not be extended.
- Mount the included antenna per the guidelines described in [Mount the Antenna on page 142](#).
- Connect the chassis ground lug to a known earth ground circuit (such as building steel) to ensure that the control system is grounded properly.
- Apply power after all connections have been made.

Mount the Antenna

The included antenna should be placed in a location that maximizes signal strength and limits impedance. Refer to the [Best Practices for Installation and Setup of Crestron RF Products](#).

Install IR Emitters (Optional)

The control system ships with four IR emitters, which adhere to the IR sensor window of a display, optical disc player, or any other IR-controlled device. Each IR emitter has a 2-pin terminal block that connects to the **IR - SERIAL** port on the control system, providing a one-way IR control interface to the connected device.

NOTE: The white-traced wire on the IR emitter is positive and connects to one of the **IR - SERIAL** port pins labeled "S."

Position the IR Emitter

The IR emitter works best for most devices when positioned directly over the device IR sensor. However, operation is more consistent for some devices when the IR emitter is offset one or two inches from the device IR sensor.

To position the IR emitter, send commands from the control system while moving the IR emitter around the front panel of the device. When operation is consistent and reliable, attach the IR emitter using the procedure described in [Attach the IR Emitter on page 117](#).

Attach the IR Mask

Attach the IR mask (packaged with the IR emitter) when two or more identical devices are being controlled using IR. The IR mask prevents stray IR output from controlling another device accidentally.

Place the IR mask over the IR emitter shell as shown in the following illustration. Do not remove the clear adhesive strips from the IR emitter shell or the IR mask.

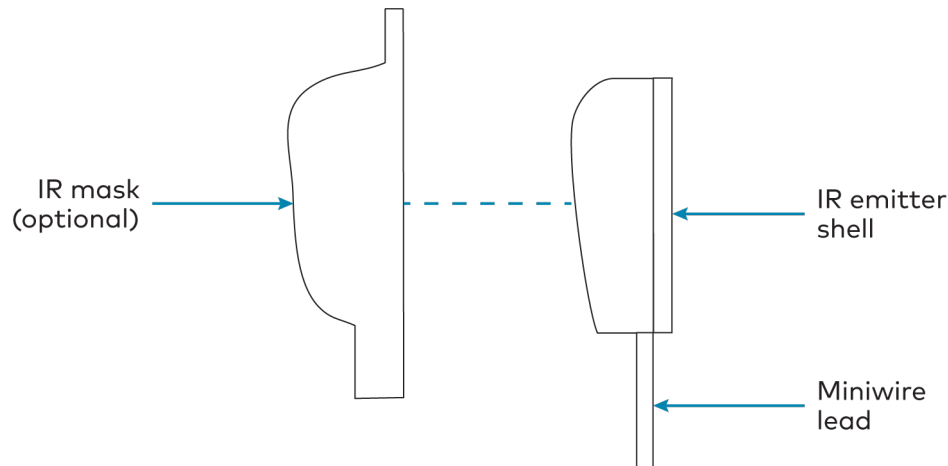

Attach the IR Emitter

1. Peel off the clear adhesive strip on the back of the IR emitter shell and the IR mask (if attached).

2. Affix the IR emitter by pressing it firmly to the desired location on the front panel of the controlled device.

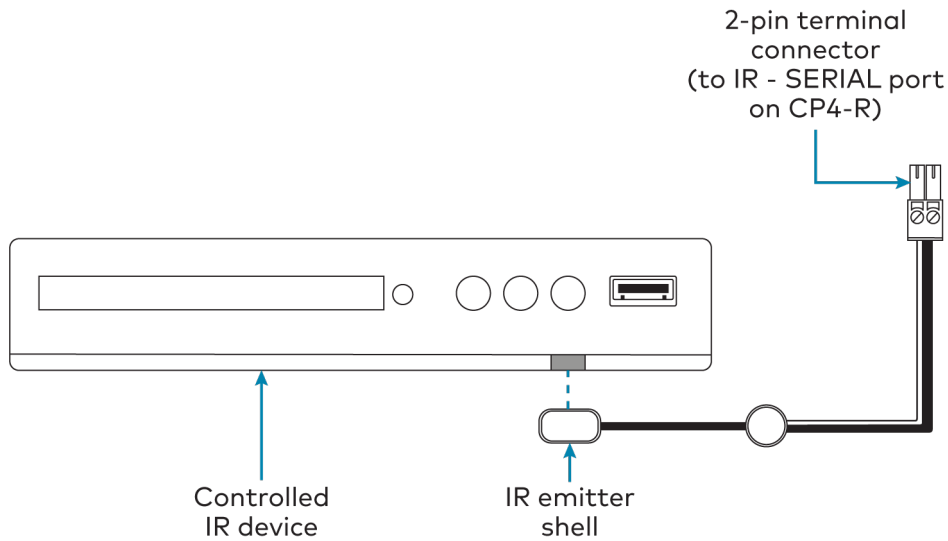

If the IR emitter must be removed and repositioned for any reason, it may be necessary to replace the adhesive on the IR emitter with a new piece of two-sided tape.

NOTE: The IR emitter is a pure infrared emitter that does not emit any visible light. To test that the IR emitter is working properly, trigger an IR command from the control system. Then, use a digital camera device (such as a smart phone) to record a video of the IR emitter while it is being triggered. If the IR signal is visible in the video during playback, the IR emitter is working properly.

PRO4 Installation

Use the following procedures to install the PRO4.

In the Box

Qty.	Description
1	PRO4, 4-Series™ Control System
Additional Items	
2	Bracket, Rack Ear (2056627)
4	Foot, Rubber (2002389)
4	Connector, 3-Pin (2003575)
1	Connector, 4-Pin (2003576)
2	Connector, 5-Pin (2003577)
4	Connector, 8-Pin (2003580)
1	Connector, 9-Pin (2003581)
1	Power Cord, 6 ft, 7 in. (2.01 m) (2001134)

Install the Control System

The control system may be mounted into a rack or placed onto a flat surface.

Rack Mounting

The control system occupies 2U of rack space.

1. Use a #1 Phillips screwdriver to remove the six required screws from the control system assembly (shown in the illustration below).
2. Attach the two included rack ears with the removed screws.
3. Mount the control system into the rack with four mounting screws (not included).

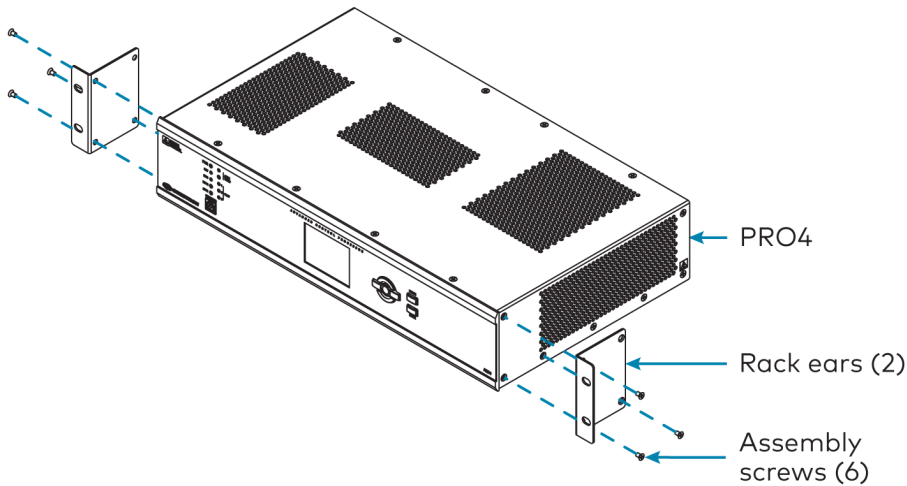

Surface Placement

1. Attach the four adhesive rubber feet near the corners on the underside of the control system.
2. Place onto a flat surface or stack with other equipment.

Connect the Control System

Make all necessary connections to the control system as shown in the following diagram.

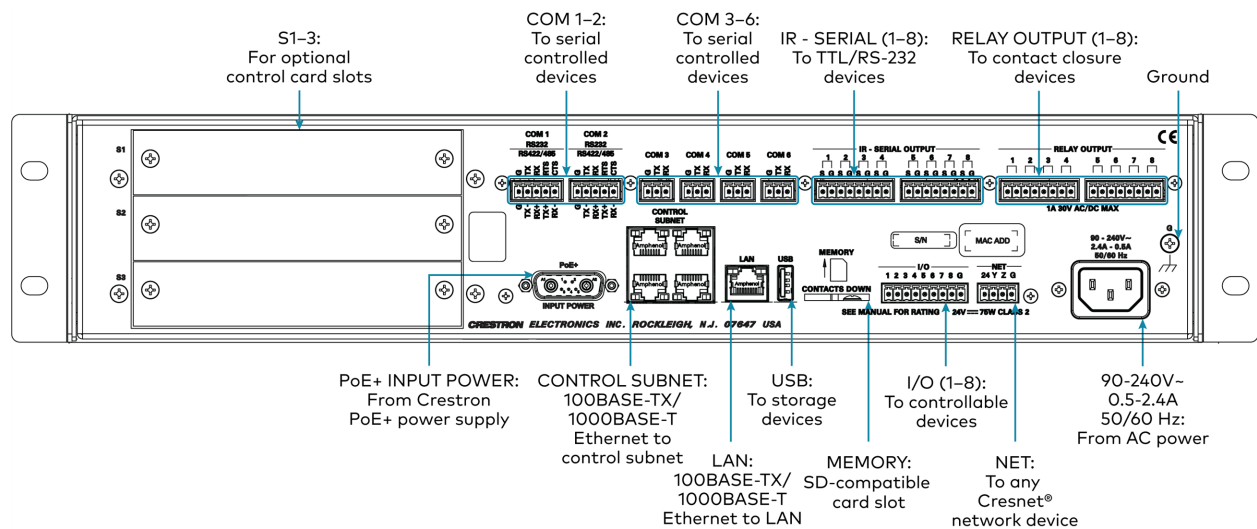

Observe the following when connecting the control system:

- Use Crestron power supplies for Crestron equipment.
- The **CONTROL SUBNET** ports are PoE+ PSE ports. Enabling PoE+ power sourcing requires connection of the **PoE+ INPUT POWER** port to an external Crestron power supply ([PW-5430DUS](#), sold separately). Wiring that connects to a PoE+ PSE is designed for intrabuilding use only.
- If PoE+ will be used, the PoE+ power supply must be connected to the control system before it is powered on.
- The **S1**, **S2**, and **S3** slots are designed to house [Crestron control cards](#).
- Connect the chassis ground lug to a known earth ground circuit (such as building steel) to ensure that the control system is grounded properly.
- Apply power after all connections have been made.

COM 1–2 Connections

Port	RS-232	RS-422 ¹	RS-485
G	GND	GND	GND ²
TX	TX (from control system)	TX- (from control system)	TX-/RX-
RX	RX (to control system)	RX+ (to control system)	Not used
RTS	RTS (from control system)	TX+ (from control system)	TX+/RX+
CTS	CTS (to control system)	RX- (to control system)	Not used

1. RS-422 transmit and receive are balanced signals that require two lines plus a ground in each direction. RXD+ and TXD+ should idle high (going low at start of data transmission). RXD- and TXD- should idle low (going high at start of data transmission). If necessary, RXD+/RXD- and TXD+/TXD- may be swapped to maintain correct signal levels.
2. A ground terminal connection is recommended but not required.

Connect the Control Subnet

The PRO4 has a dedicated Control Subnet that is used for communication between the control system and Crestron Ethernet devices without interference from other traffic on the network.

CAUTION: Do not connect the **CONTROL SUBNET** ports to the LAN. The **CONTROL SUBNET** ports must only be connected to Crestron Ethernet devices.

For more information on using the Control Subnet, refer to [Control Subnet on page 238](#).

RMC4 Installation

Use the following procedures to install the RMC4.

In the Box

Qty.	Description
1	RMC4, 4-Series™ Control System
Additional Items	
1	Bracket, Mounting, Integrated DIN Rail Clip (4519035)
2	Screw, 6-32 x 3/8 in., Phillips (2007225)
2	Connector, 3-Pin (2003575)
2	Connector, 4-Pin (2003576)
1	Connector, 5-Pin (2003577)

Mount the Control System

The control system can be mounted onto a flat surface or a standard DIN rail using the included mounting bracket.

CAUTION: To prevent overheating, do not operate the control system in an area that exceeds the environmental temperature range (32 to 104°F or 0 to 40°C) for this device.

Optional rack mount and pole mount kits (not included) are also available for use with the RMC4. For more information, refer to the [RMK-IFE-1U Installation Guide](#) and the [PLMK-IFE-101 Installation Guide](#).

1. Attach the four adhesive rubber feet near the corners on the underside of the control system.
2. Place onto a flat surface or stack with other equipment.

Use four mounting screws (not provided) to mount the control system to a flat surface such as a wall or under a table. The control system can also be mounted behind a flat panel display or similar equipment.

Surface Mounting

1. Detach the control system from the mounting bracket by pulling the left and right flanges of the bracket outward to release the tabs that hold the control system in place.

2. Attach the mounting bracket to the surface by using four appropriate mounting screws (not included) through the four mounting holes on the bottom of the bracket.
3. Align the slots on the bottom of the control system with the tabs on the mounting bracket.
4. Press the control system into the bracket until it snaps into place.
5. (Optional) Secure the control system to the bracket using the two included 6-32 x 3/8 in. screws as shown in the following illustration.

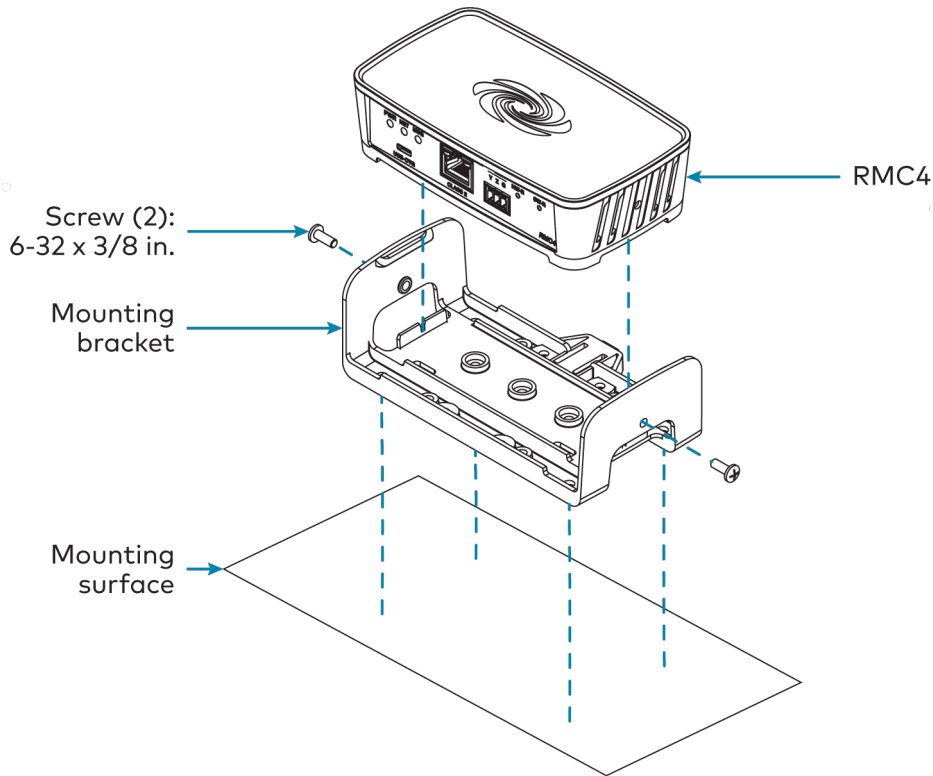

DIN Rail Mounting

1. Detach the control system from the mounting bracket by pulling the left and right flanges of the bracket outward to release the tabs that hold the control system in place.
2. Pull the DIN rail release tab downward using a flat-head screwdriver.
3. Position the DIN rail mounting tabs (located on the rear of the bracket) over the top edge of the DIN rail.
4. Push the DIN rail release tab upward to lock the mounting bracket onto the rail.
5. Align the slots on the bottom of the control system with the tabs on the mounting bracket.
6. Press the control system into the bracket until it snaps into place.

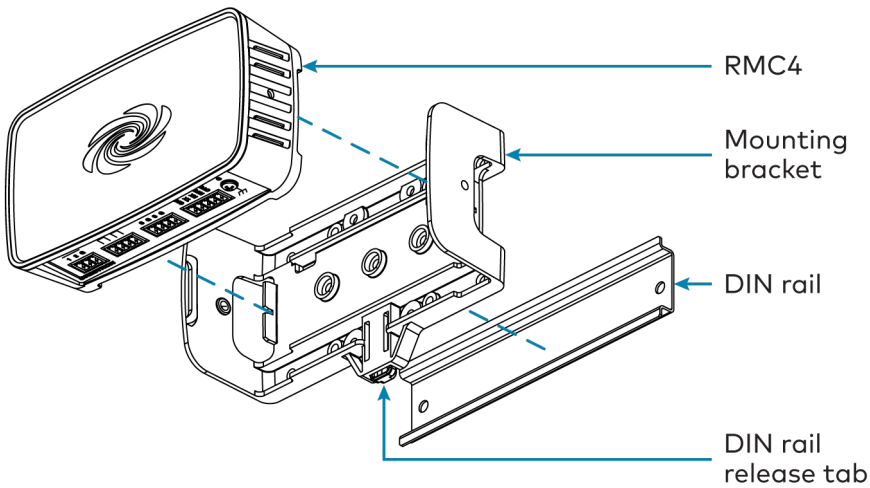

NOTE: Do not use the included screws to secure the bracket to the bottom of the control system when mounting into a DIN rail, as it will then not be possible to remove the control system from the DIN rail.

Connect the Control System

Make all necessary connections to the control system as shown in the following diagrams.

Front Panel Connections

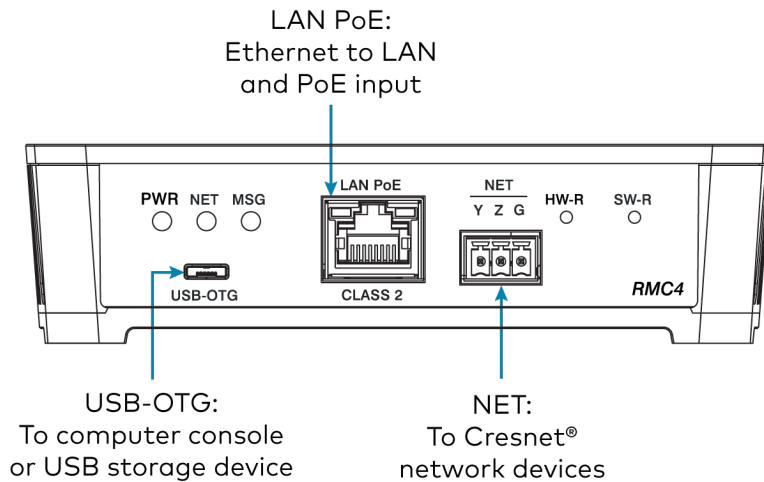

Rear Panel Connections

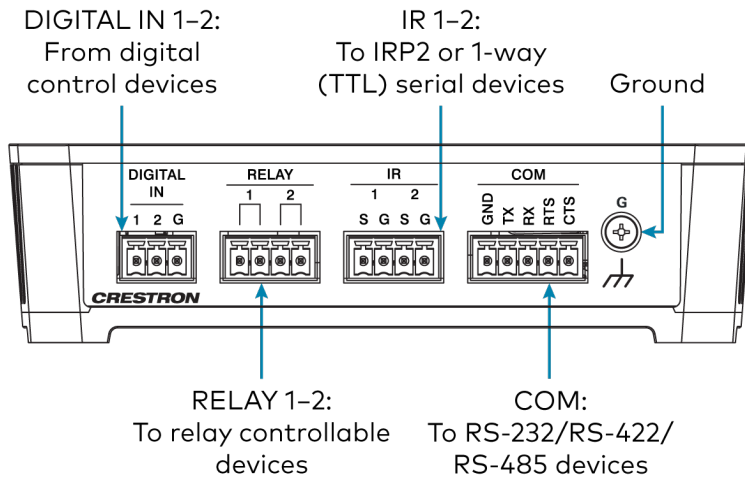

Observe the following when connecting the control system:

- Use Crestron power supplies for Crestron equipment.
- The control system is powered over PoE (Power over Ethernet) via a Crestron PoE injector ([PWE-4803RU](#)) or a Crestron PoE switch ([CEN-SW-POE-5](#) or [CEN-SWPOE-16](#)). All PoE equipment is sold separately.
- Connect the chassis ground lug to a known earth ground circuit (such as building steel) to ensure that the control system is grounded properly.
- Apply power after all connections have been made.

COM 1 Connections

Port	RS-232	RS-422 ¹	RS-485
G	GND	GND	GND ²
TX	TX (from control system)	TX- (from control system)	TX-/RX-
RX	RX (to control system)	RX+ (to control system)	Not used
RTS	RTS (from control system)	TX+ (from control system)	TX+/RX+
CTS	CTS (to control system)	RX- (to control system)	Not used

1. RS-422 transmit and receive are balanced signals that require two lines plus a ground in each direction. RXD+ and TXD+ should idle high (going low at start of data transmission). RXD- and TXD- should idle low (going high at start of data transmission). If necessary, RXD+/RXD- and TXD+/TXD- may be swapped to maintain correct signal levels.
2. A ground terminal connection is recommended but not required.

Configuration

Prior to configuration, ensure the device is running the latest firmware. To update the firmware, refer to [Update Firmware on page 162](#).

Use the following procedures to configure a 4-Series control system.

NOTE: Crestron Home® OS control systems and Crestron Virtual Control server-based control systems are configured differently than standard 4-Series control system models.

- To configure a Crestron Home OS control system (CP4-R, DIN-AP4-R, PC4-R, or MC4-R), refer to the [Crestron Home OS Product Manual](#).
- To configure a Crestron Virtual Control server-based control system (VC-4), refer to the [Crestron Virtual Control Server Software Product Manual](#)

This section provides the following information:

- [Initial Setup on page 154](#)
- [Web Configuration on page 160](#)

Initial Setup

Use the following procedures to set up the 4-Series control system following installation.

Access the Web Configuration Interface

The control system may be monitored and configured using its web configuration interface. The interface can be accessed via the control system IP address or the XiO Cloud® service as described in the following sections.

NOTE: The PRO4 can also be configured using its front panel LCD display and navigational pad.

IP Address

To access the web configuration interface using the control system IP address:

NOTE: The control system ships with DHCP turned on. A DHCP server is required to access the web configuration interface via the control system IP address. A static IP address can be configured for the control system after accessing the web configuration interface as described in [Network on page 172](#).

1. Connect the control system to the Ethernet network.
2. Locate the control system and its IP address on the network. The **Device Discovery** tool in [Crestron Toolbox™ software](#) can be used to discover the control system IP address.
3. Enter the control system IP address into a web browser.

NOTE: If using IPv6, the web configuration interface is not accessible via a link-local address.

XiO Cloud Service

The [XiO Cloud® service](#) allows supported devices across an enterprise to be managed and configured from one central, secure location in the cloud. The control system is configured to connect to the service by default.

NOTE: An XiO Cloud account is required to use the service. To register for an XiO Cloud account, refer to www.crestron.com/Support/Tools/Licensing-Registration/XiO-Cloud-Registration-Room-Licenses.

To connect the control system to the XiO Cloud service:

1. Record the MAC address and serial number that are labeled on the shipping box or the control system. The MAC address and serial number are required to add the control system to the XiO Cloud service.

2. Log in to your XiO Cloud account at portal.crestron.io.
3. Claim the control system to the XiO Cloud service as described in the [XiO Cloud User Guide](#).

Once the control system is claimed, select it from the cloud interface to view its status and settings. The control system may now also be managed and assigned to a group or room. For more information, refer to the [XiO Cloud User Guide](#).

NOTE: For XiO Cloud accounts with room-based licenses, the control system must be added to a licensed room before its status and settings can be viewed.

Create an Admin Account

The first time the web configuration interface is accessed, a page is displayed asking the user to create an admin account. A similar message is displayed when connecting to the control system in Crestron Toolbox software if an admin account has not already been created.

To create an admin account:

1. Enter a username and password for the admin account in the appropriate text fields.

CAUTION: Do not lose the username and password for the admin account, as the control system must be reset to factory settings to regain access.

2. Select **OK** to create the admin account. The web configuration interface refreshes to show the standard login page.
3. Reenter the credentials created in step 1 and select **Sign In**.

NOTE: The username and password must also be entered when connecting from Crestron Toolbox or XPanel.

The web configuration interface is displayed upon successful login. For more information on configuring the control system via its web configuration interface, refer to [Web Configuration on page 160](#).

Web Configuration Interface

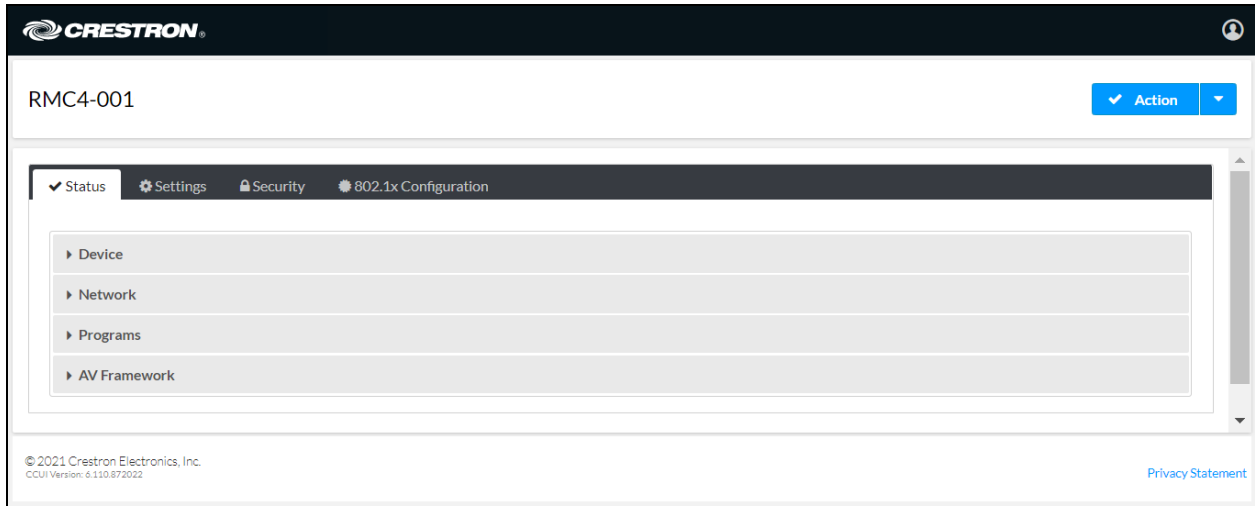

Set the Time Zone

The time zone must be set on the control system to ensure that the correct time settings are pushed to controlled devices.

To set the time zone:

1. Access the web configuration interface using either the device IP address or the XiO Cloud service.
 2. Navigate to **Settings > System Setup**.
 3. Expand the **Date/Time** subsection to display date and time settings.
- Select the + (plus) icon next to **Date/Time** to display the following time and date settings.

Settings Tab - System Setup (Date/Time)

— Date/Time

Synchronization

Time Synchronization

[Synchronize Now](#)

NTP Time Servers

<input type="checkbox"/>	Address	Port	Authentication Method	Authentication Key	Key ID
<input type="checkbox"/>	pool.ntp.org	123	None	0

[+ Add](#) [- Remove](#)

Configuration

Time Zone: (UTC - 05:00) Eastern Time (US & Ca) ▼

Date: 12/08/2021

Time: 17:01

4. Select the time zone where the control system is used from the **Time Zone** drop-down menu.
5. Select **Save Changes** on the top right of the screen.

Assign the RF Channel (MC4/MC4-I Only)

Set the RF channel of the control system prior to operation. The control system can operate on channels 11 through 26. Crestron recommends using RF channel 15 or 20. The default RF channel is 15.

For best performance when installing the control system in a Wi-Fi® network environment, do not set the RF channel within a Wi-Fi channel band. Refer to the information below when choosing the RF channel in a Wi-Fi environment:

- Gateway channels 11 through 14 are within the Wi-Fi channel 1 band.
- Gateway channel 15 is adjacent to Wi-Fi channels 1 and 6.
- Gateway channels 16 through 19 are within the Wi-Fi channel 6 band.
- Gateway channel 20 is adjacent to Wi-Fi channels 6 and 11.
- Gateway channels 21 through 24 are within the Wi-Fi channel 11 band.
- Gateway channel 25 is adjacent to Wi-Fi channel 11.
- Gateway channel 26 is neither within nor adjacent to any Wi-Fi band.

NOTE: Crestron RF devices are divided into two categories: infiNET EX® network devices and Crestron Extended Range (ER) devices. infiNET EX devices automatically set their RF channel assignment to match the gateway's channel, whereas ER devices must have their RF channel manually assigned to match the gateway's channel.

Use Crestron Toolbox to set the control system RF channel. From the **EasyConfig** tool, navigate to **Functions > infiNET EX Gateway**. Refer to the Crestron Toolbox help file for more information.

Acquire Wireless Devices (MC4/MC4-I Only)

Crestron infiNET EX and ER devices can communicate with the control system after they have been acquired by the control system internal gateway. A device can be acquired to only one gateway. Acquire mode is activated from Crestron Toolbox or by pressing **ACQUIRE** on the control system front panel.

For optimum performance when installing the control system in a Wi-Fi network environment, do not set the RF channel within a Wi-Fi channel band. Refer to the information below when choosing the RF channel in a Wi-Fi environment:

NOTES:

- Use Crestron Toolbox to set the RF channel before starting the acquiring process. Refer to [Assign the RF Channel \(MC4/MC4-I Only\) on page 157](#).

- Acquire mode can be activated approximately 15 seconds after power is applied to the control system.
- The control system must be put in Acquire mode before an infiNET EX device is put into Acquire mode.

To acquire an infiNET EX or ER device to the control system:

1. Press **ACQUIRE** on the control system to enter Acquire mode. The Acquire LED lights to indicate that the unit is ready to acquire.

NOTE: Acquire mode deactivates after one hour by default. This timeout period can be modified in Crestron Toolbox.

2. Place the infiNET EX or ER device within range of the gateway (50 ft or 15 m), and put it into Acquire mode as described in its documentation. The device is acquired within two minutes of putting it into Acquire mode.
3. Repeat step 2 for each device that must be acquired.
4. Press **ACQUIRE** on the control system to leave Acquire mode.

Pair with Apple HomeKit

The control system can be paired with Apple® HomeKit® technology to support communication between the control system and Apple HomeKit devices and accessories.

For pairing instructions and to locate the unique QR code required for pairing, refer to the Product Information document that shipped with your control system.

Configure .AV Framework Software

The control system provides native support for the .AV Framework™ software program. .AV Framework software is a web-based management solution that is used to deploy scalable Crestron® enterprise room solutions without requiring any programming. For more information on the capabilities supported by .AV Framework, visit www.crestron.com/avframework.

To turn on the .AV Framework software program for the control system:

1. Open the web configuration interface as described in [Access the Web Configuration Interface on page 154](#).
2. Navigate to **Settings > AV Framework**.

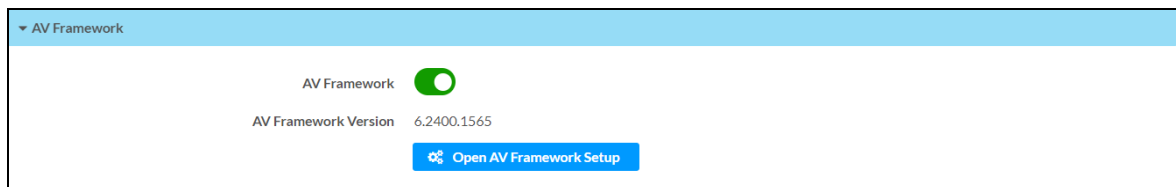

3. Turn on the **AV Framework** toggle.

4. Save the configuration. The control system will restart with the native .AV Framework software program turned on.

After the control system restarts, select **Open AV Framework Setup** to launch the .AV Framework web configuration utility. For more information on configuring .AV Framework for the control system, refer to the [.AV Framework Software for 4-Series Control Systems Operations Guide](#).

Web Configuration

The control system may be monitored and configured using its web configuration interface. The interface can be accessed via the control system IP address or the XiO Cloud® service as described in [Initial Setup on page 154](#).

Web Configuration Interface

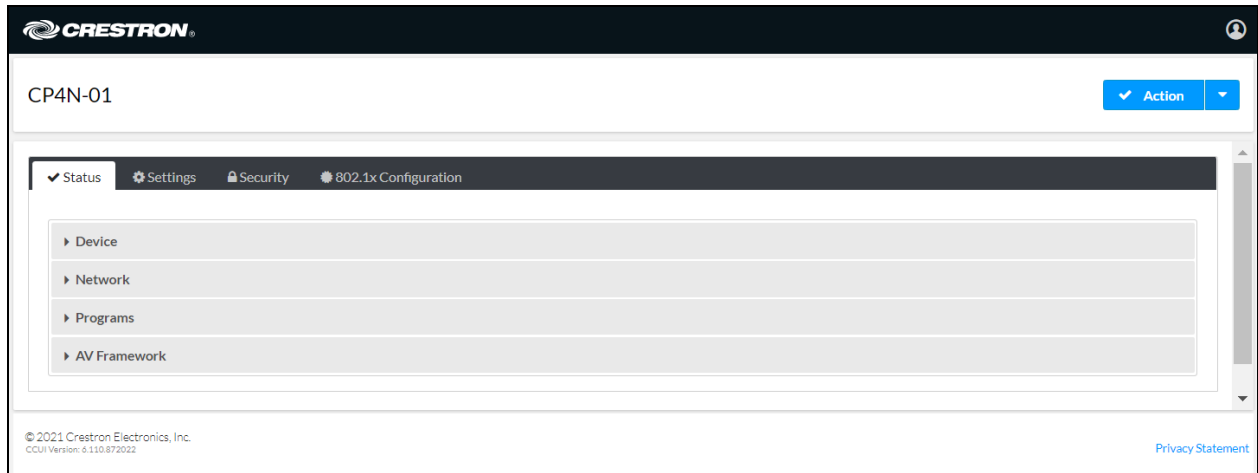

The configuration interface provides the following tabs:

- **Status:** Used to monitor control system status
- **Settings:** Used to configure control system settings
- **Security:** Used to configure authentication and other security settings
- **802.1x Configuration:** Used to configure IEEE 802.1X network authentication for control system security

The **Status** tab is the default tab that is displayed, as shown in the preceding image.

Actions Menu

The configuration interface provides an **Actions** drop-down menu on the top right of the page. The **Actions** menu may be accessed at any time.

Actions Menu

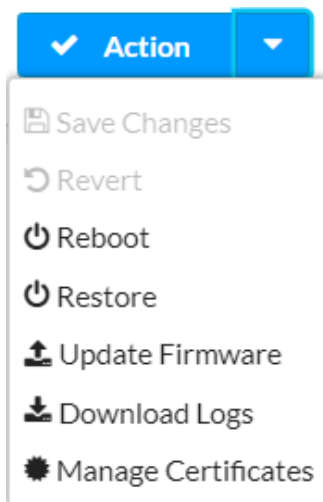

Once any changes have been made to the control system configuration, the **Actions** button changes to a **Save Changes** button. Select **Save Changes** to save changes to the configuration settings.

If a restart is required after changes have been saved, a dialog box is displayed asking whether the restart should be performed. Select **Yes** to restart the device or **No** to cancel the restart.

The **Actions** menu provides the following selections.

Save Changes

Select **Save Changes** to save any changes made to the configuration settings.

Revert

Select **Revert** to revert the control system back to the last saved configuration settings.

Reboot

Select **Reboot** to restart the control system.

After **Reboot** is selected, a dialog box is displayed asking whether the control system should be restarted. Select **Yes** to restart the device or **No** to cancel the restart.

Restore

Select **Restore** to restore the control system configuration settings to their default values.

After **Restore** is selected a dialog box is displayed asking whether the device settings should be restored. Select **Yes** to restore the settings or **No** to cancel the restore.

Update Firmware

Select **Update Firmware** to upgrade the control system firmware manually with a downloaded PUF (package update file). The **Firmware Upgrade** dialog box opens.

NOTE: Any control systems that ship with an upgraded Ethernet PHY card must run firmware version 2.8000.xxxxx or greater. To determine the Ethernet PHY card version on your control system model, navigate to **Status > Device** in the web configuration UI, expand the **More Details** section, and then note the value listed next to **Ethernet Phy**. If the value is "Rev2," the control system is running the upgraded Ethernet PHY card and cannot have its firmware downgraded below 2.8000.xxxxx.

Firmware Upgrade Dialog Box

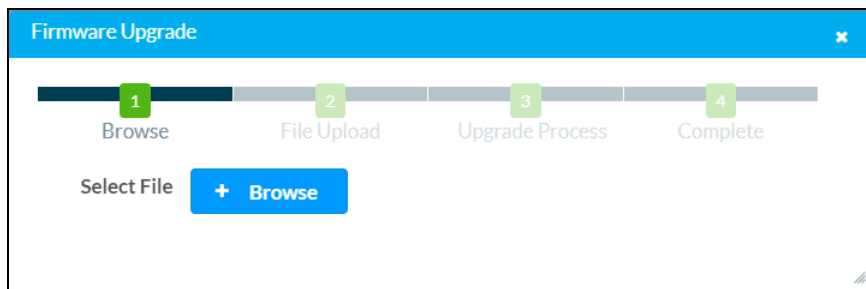

To upload a firmware PUF through the web configuration interface:

NOTE: Visit the appropriate device product page or www.crestron.com/Support/Resource-Library to download the latest firmware PUF.

1. Select **Browse**, and then navigate to the firmware PUF on the host computer.
2. Select the firmware PUF, and then select **Open**.
3. Select **Load** to load the PUF to the control system. The upload progress is shown in the dialog box.
4. Once the control system has completed the firmware upgrade, select **OK**.

Select the **x** button to close the **Firmware Upgrade** dialog box at any time during the upgrade process. Selecting the **x** button before the PUF is uploaded cancels the upgrade.

Download Logs

Select **Download Logs** to download the control system message logs for diagnostic purposes. The message files download as a compressed .tgz file. Once the compressed file is downloaded, extract the message log files to view them.

Manage Certificates

Select **Manage Certificates** to manage any certificates that are installed on the control system. For more information on certificate management, refer to [802.1x Configuration on page 196](#).

Status

Select the **Status** tab on the top left of the configuration interface to display selections for viewing the status of device, network, and USB, and .AV Framework™ software settings.

Select a selection name to expand the selection. If the selection is expanded, select the selection name again to collapse the section.

Status Tab Selections



Device

Select **Device** to view general device information.

Status Tab - Device

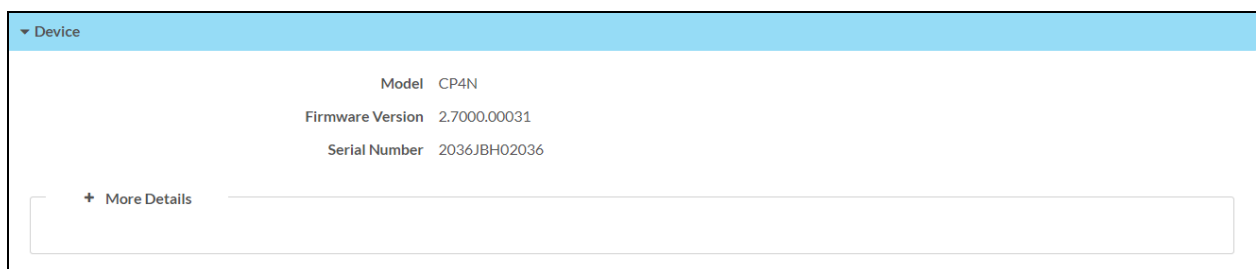

The following **Device** information is displayed:

- **Model:** The control system model name
- **Serial Number:** The control system serial number
- **Firmware Version:** The firmware version loaded onto the control system

Select **+ More details** at the bottom of the **Device** tab to display an expanded section that shows more control system information. If **+ More Details** is selected, select **- Less Details** to collapse the section.

Network

Select **Network** to view the status of the network settings for the control system.

Status Tab - Network

▼ Network

Hostname CP4N-01

IPv6 Enabled Yes

DNS Servers 0:1011::, fe80::210:7fff:feee:bfa2%eth0

NIC 1 DNS Servers 172.22.0.2(DHCP)

- Adapter 1

Domain Name

DHCP Enabled On

IP Address 10.0.1.255

Subnet Mask 255.255.255.0

Default Gateway 10.0.1.1

Link Active true

MAC Address 00:10:7f:ee:bf:00

IPv4

IPv6

DHCP Enabled On

Default Gateway ::

Subnet Prefix Length	IP Address	Type
64	fe80::210:7fff:feee:bfa1	Link Local

- Control Subnet

Auto Network Addressing true

Network 0.0.0.0/0

Link Active false

Isolation Mode false

MAC Address 00:10:7f:ee:bf:00

IPv4

IPv6

DHCP Enabled On

Default Gateway ::

Subnet Prefix Length	IP Address	Type
64	fd29:51:b75d::2	Static
64	fe80::210:7fff:feee:bfa2	Link Local

The following **Network** information is displayed:

- **Hostname:** The control system host name
- **IPv6 Enabled:** Reports whether IPv6 addressing is turned on (**Yes**) or not (**No**)
- **IPv6:** Contains settings for IPv6 DNS (domain name server) addresses.
 - **DNS Servers:** The DNS addresses used to resolve the control system domain to an IPv6 address
- **IPv4:** Contains settings for IPv4 DNS addresses.
 - **NIC 1 DNS Servers:** The DNS addresses used to resolve the control system domain to an IPv4 address

Select the + (plus) icon next to **Adapter 1** to display the following Ethernet settings:

- **Domain Name:** The control system domain name
- **IPv4:** Contains settings for IPv4 Ethernet addressing
 - **DHCP Enabled:** Reports whether the IPv4 Ethernet address is dynamic (**Yes**) or static (**No**)
 - **IP Address:** The control system IPv4 Ethernet address, shown only if an Ethernet connection is active
 - **Subnet Mask:** The control system subnet mask address, shown only if an Ethernet connection is active
 - **Default Gateway:** The gateway router address, shown only if an Ethernet connection is active
 - **Link Active:** Reports the status of the Ethernet connection (A **true** message indicates that the Ethernet connection is active, while a **false** message indicates that the Ethernet connection is inactive.)
 - **MAC Address:** The unique MAC (media access control) address for the Ethernet adapter
- **IPv6:** Contains settings for IPv6 Ethernet addressing
 - **DHCP Enabled:** Reports whether the IPv6 Ethernet address is dynamic (**Yes**) or static (**No**)
 - **Default Gateway:** The gateway router address, shown only if an Ethernet connection is active and IPv6 addressing is turned on
 - Each IPv6 Ethernet address configured for the control system is displayed in a table with the following information:
 - **Subnet Prefix Length:** The subnet prefix length for the IPv6 Ethernet address
 - **IP Address:** The IPv6 Ethernet address
 - **Type:** The IPv6 Ethernet address type

Select the + (plus) icon next to **Control Subnet** to display the following Control Subnet settings (AV4, PRO4, and CP4N only):

- **IPv4:** Contains settings for IPv4 Control Subnet addressing
 - **Auto Network Addressing:** Reports whether the IPv4 network address for the Control Subnet is configured automatically (**true**) or manually (**false**)
 - **Network:** The Control Subnet IPv4 network address, shown only if a Control Subnet connection is active
 - **Link Active:** Reports the status of the Control Subnet connection (A **true** message indicates that the Control Subnet connection is active, while a **false** message indicates that the Control Subnet connection is inactive.)
 - **Isolation Mode:** Reports the status of the Control Subnet isolation mode (A **true** message indicates that isolation mode is turned on, while a **false** message indicates that isolation mode is turned off.)
 - **MAC Address:** The unique MAC (media access control) address for the Control Subnet adapter
- **IPv6:** Contains settings for IPv6 Control Subnet addressing
 - **DHCP Enabled:** Reports whether the Control Subnet IPv6 network address is dynamic (**Yes**) or static (**No**)
 - **Default Gateway:** The gateway router address, shown only if an Ethernet connection is active and IPv6 addressing is turned on

Each Control Subnet IPv6 network address configured for the control system is displayed in a table with the following information:

- **Subnet Prefix Length:** The subnet prefix length for the Control Subnet IPv6 network address
- **IP Address:** The Control Subnet IPv6 network address
- **Type:** The Control Subnet IPv6 network address type (unicast, anycast, or multicast)

Program

Select **Program** to view the status of the program and secondary mode settings for the control system.

Status Tab - Program

▼ Programs	
Number of Licensed Programs	10
Slave Mode	Disabled
Master IP/Hostname	
Master IP ID	
Slave Mode Status	

The following **Program** information is displayed:

- **Number of Licensed Programs:** The number of licensed programs supported by the control system

NOTE: The MC4, MC4-I, and RMC4 are designed to run a single program out of the box. The optional modular programming architecture (MPA) add-on allows these control systems to run up to ten programs simultaneously via a [SW-RMC3-10PROG](#) license.

- **Secondary Mode:** Reports whether the control system is running in secondary mode (**Enabled**) or not (**Disabled**)
- **Primary IP/Hostname:** The IP address or host name of the primary control system, shown only if secondary mode is turned on
- **Primary IP ID:** The IP ID of the primary control system connection, shown only if secondary mode is turned on
- **Secondary Mode Status:** Indicates the connection status to a primary control system while in secondary mode, shown only if secondary mode is turned on

If one or more programs have been loaded to the control system, expandable subsections are shown that correspond with the program slot. Expand the subsection for a given program slot to display details about the loaded program.

AV Framework

Select **AV Framework** to view the status of the native .AV Framework software program running on the control system

Status Tab - AV Framework

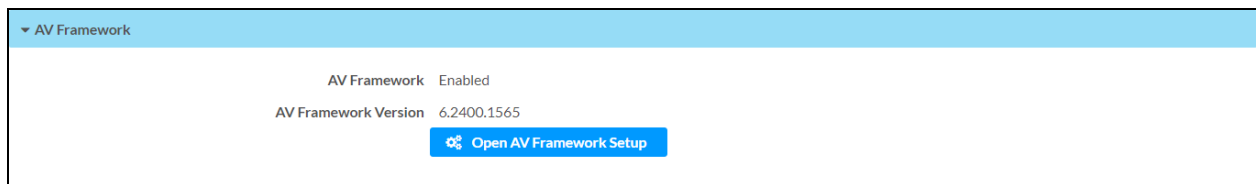

The following **AV Framework** information is displayed:

- **AV Framework:** Reports whether the native .AV Framework software program has been turned on (**Enabled**) or not (**Disabled**)
- **AV Framework Version:** Reports the version of the native .AV Framework software program running on the control system, shown only if the native .AV Framework software program is turned on

If the native .AV Framework software program is turned on, an **Open AV Framework Setup** button is provided to launch the .AV Framework web configuration utility. For more information on configuring .AV Framework for the control system, refer to the [.AV Framework Software for 4-Series Control Systems Operations Guide](#).

Settings

Select the **Settings** tab on the top left of the configuration interface to display selections for configuring various control system settings.

Settings Selections



Each selection is described in the sections that follow.

NOTE: If an invalid value is entered for a setting, the web interface will not allow changes to be saved until a valid value is entered. Red text is displayed next a setting to indicate an invalid value.

System Setup

Select **System Settings** to configure general network and control system settings.

Settings Tab - System Setup



Date/Time

Select the + (plus) icon next to **Date/Time** to display the following time and date settings.

Settings Tab - System Setup (Date/Time)

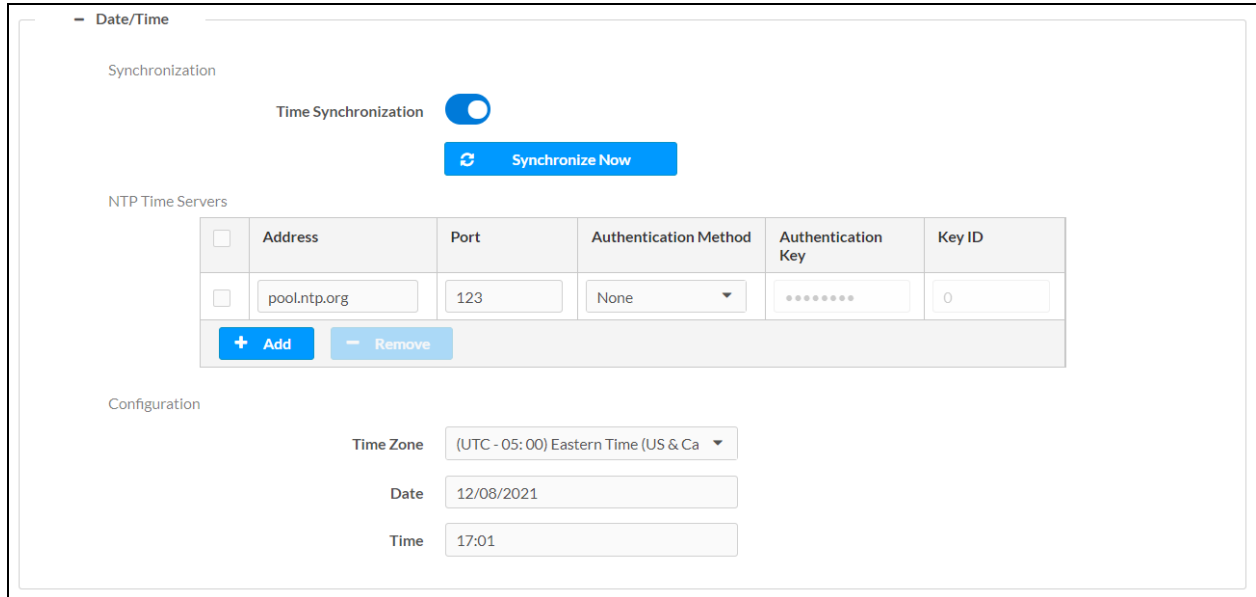

The screenshot displays the 'Date/Time' settings page. It is divided into three main sections:

- Synchronization:** Features a 'Time Synchronization' toggle switch that is currently turned on (blue). Below the toggle is a blue button labeled 'Synchronize Now' with a refresh icon.
- NTP Time Servers:** A table with columns for 'Address', 'Port', 'Authentication Method', 'Authentication Key', and 'Key ID'. There is one server listed: 'pool.ntp.org' on port '123' with 'None' as the authentication method and '0' as the key ID. Below the table are '+ Add' and '- Remove' buttons.
- Configuration:** Contains three input fields: 'Time Zone' set to '(UTC - 05:00) Eastern Time (US & Ca)', 'Date' set to '12/08/2021', and 'Time' set to '17:01'.

- **Time Synchronization:** Turn on the toggle to use time synchronization via NTP (Network Time Protocol).
- **Synchronize Now:** With **Time Synchronization** turned on, select **Synchronize Now** to synchronize the control system with the NTP server(s) entered in the **NTP Time Servers** table.

- **NTP Time Servers:** With **Time Synchronization** turned on, use the provided table to enter information regarding the NTP server(s) used to synchronize the date and time for the control system.
 - Select **Add** to add a new NTP server entry into the table.
 - Enter the following information for each entry:
 - Enter the NTP server address into the **Address** text field.
 - Enter the NTP server port into the **Port** text field.
 - Use the **Authentication Method** drop-down menu to select the authentication method used to access the NTP server (if one exists).
 - If an authentication method is selected, enter the key used to authenticate against the NTP server into the **Authentication Key** text field.
 - If an authentication method is selected, enter the ID for the key used to authenticate against the NTP server into the **Key ID** text field.
 - To remove an entry, fill the checkbox to the left of the table entry, and then select **Delete**.

NOTE: NTP servers are configured into a particular slot. The server configured for the first table row will be the primary server used for time synchronization. The servers configured into additional table rows will be used as secondary servers.

- **Time Zone:** Select a time zone for the control system using the drop-down menu.
- **Date:** Select the date for the control system using the pop-up calendar that is displayed.
- **Time:** Select the time for the control system (in 24-hour format) using the pop-up menu that is displayed.

Web Server

Select the + (plus) icon next to **Web Server** to display the following control system web server settings.

Settings Tab - System Setup (Web Server)

The screenshot shows the 'Web Server' settings page. At the top, there is a toggle switch labeled 'Web Server Enabled' which is currently turned on. Below this, there are two text input fields: 'HTTP Port' with the value '80' and 'HTTPS Port' with the value '443'.

- Turn on the **Web Server Enabled** toggle to turn on the web server for the control system. The control system web server allows for users to upload web pages and mobility projects to a control system.
- If **Web Server Enabled** is turned on, enter an HTTP port to use for the web server in the **HTTP Port** text field. Port 80 is used by default.

- If **Web Server Enabled** is turned on, enter an HTTPS port to use for the web server in the **HTTPS Port** text field. Port 443 is used by default.

Crestron Internet Protocol

Select the + (plus) icon next to **Crestron Internet Protocol** to display the following Crestron Internet Protocol (CIP) port settings.

Settings Tab - System Setup (Crestron Internet Protocol)

The screenshot shows the 'Crestron Internet Protocol' settings tab. It contains two text input fields: 'CIP Port' with the value '41794' and 'Secure CIP Port' with the value '41796'.

- Enter the Crestron Internet Protocol port used by the control system in the **CIP Port** text field. Port 41794 is used by default.
- Enter the Secure Crestron Internet Protocol port used by the control system in the **SCIP Port** text field. Port 41796 is used by default.

SSH

Select the + (plus) icon next to **SSH** to display the following SSH (Secure Shell) settings.

Settings Tab - System Setup (SSH)

The screenshot shows the 'SSH' settings tab. It features a toggle switch for 'SSH Enabled' which is turned on, and a text input field for 'SSH Port' with the value '22'.

- Turn on the **SSH Enabled** toggle to turn on SSH for the control system.
- If **SSH Enabled** is turned on, the SSH port for the control system is displayed next to **SSH Port**.

Web XPanel

Select the + (plus) icon next to **Web XPanel** to display the following control system Web XPanel settings.

Settings Tab - System Setup (Web XPanel)

The screenshot shows the 'Web XPanel' settings tab. It contains two toggle switches: 'Web XPanel Enabled' and 'Secure Web XPanel Enabled', both of which are turned off. Below them are text input fields for 'Domain' with the value '*' and 'Port(s)' with the value '41794'.

- Turn on the **Web XPanel Enabled** toggle to turn on the Web XPanel functionality for the control system.
- Turn on the **Secure Web XPanel Enabled** toggle to turn on a secure Web XPanel connection for the control system. If this toggle is turned on, the Web XPanel can only connect to the control system over encrypted TLS/SSL.
- Enter a domain name for the Web XPanel in the **Domain** text field.
- Enter one or more ports for the Web XPanel in the **Port(s)** text field. Port 41794 is used by default.

NOTE: Enter "*" to open all ports for the Web XPanel. A range of ports can also be specified.

Network

Select **Network** to display the following network settings.

Settings Tab - Network

▼ Network

Hostname *

IPv6 Enabled ⓘ

IPv6

Primary Static DNS

Secondary Static DNS

IPv4

Primary Static DNS

Secondary Static DNS

— Adapter 1

IPv4

Domain

DHCP

IP Address

Subnet Mask

Default Gateway

IPv6

DHCP

Default Gateway ::

IPv6 Address with Prefix

No records found

+ Add - Remove

— Control Subnet

Auto Network Addressing

Network

Isolation Mode

Start Program After Router is Online

Port Map

	External Port	Internal Port	IP Address/Host name	Protocol
No records found				

+ Add ✕ Remove

IPv6 Address with Prefix

No records found

+ Add - Remove

- **Hostname:** Enter the control system host name.
- **IPv6 Enabled:** Turn on the toggle to use IPv6 addressing for the control system.
- **IPv6:** Use these settings to configure DNS addresses for IPv6 addressing.
 - **Primary Static DNS:** Enter the primary DNS address for an IPv6 address.
 - **Secondary Static DNS:** Enter the secondary DNS address for an IPv6 address.
- **IPv4:** Use these settings to configure DNS addresses for IPv4 addressing.
 - **Primary Static DNS:** Enter the primary DNS address for an IPv4 address.
 - **Secondary Static DNS:** Enter the secondary DNS address for an IPv4 address.

Select the + (plus) icon next to **Adapter 1** to display the following Ethernet settings:

- **Domain:** Enter the fully qualified domain name on the network.
- **IPv4:** Use these settings to configure IPv4 Ethernet addressing on the network.
 - **DHCP:** Turn on the toggle to use DHCP for the IPv4 Ethernet connection.

NOTE: If DHCP is turned on, IP does not function until a reply has been received from the server. The control system broadcasts requests for an IP address periodically.

- **IP Address:** If **DHCP** is turned off, enter the control system IPv4 address on the network.
- **Subnet Mask:** If **DHCP** is turned off, enter the control system subnet mask address on the network.
- **Default Gateway:** If **DHCP** is turned off, enter the gateway router address on the network.
- **IPv6:** Use these settings to configure IPv6 Ethernet addressing on the network.
 - **DHCP:** Turn on the toggle to use DHCP for the IPv6 Ethernet connection.

NOTE: If DHCP is turned on, IP does not function until a reply has been received from the server. The control system broadcasts requests for an IP address periodically.

- **Default Gateway:** If **DHCP** is turned off, enter the gateway router address on the network.

- **IPv6 Address with Prefix:** With **IPv6 Enabled** turned on, use the provided table to add IPv6 Ethernet addresses to the control system.
 - Select **Add** to add a new IPv6 Ethernet address to the control system.
 - Enter the following information for each entry:
 - Enter the IPv6 Ethernet address into the **Enter IPv6 Address** text field.
 - Enter the prefix for the IPv6 Ethernet address into the text field following the address.
 - If desired, use the copy button  to copy the IPv6 Ethernet address to the clipboard.
 - To remove an entry, fill the checkbox to the left of the table entry, and then select **Remove**.

NOTE: An "x" icon is shown to the right of the IPv6 Ethernet address prefix in a table row if the IPv6 address format is invalid or is missing a prefix. Hover over the icon to view a message explaining the issue.

Select the + (plus) icon next to **Control Subnet** to display the following Control Subnet settings.

NOTE: For more information on the Control Subnet, refer to [Control Subnet on page 238](#).

- Turn on the **Auto Network Addressing** toggle to assign a network address for the Control Subnet automatically. If this toggle is turned off, a static address must be entered in the **Network** text field below.
- If **Auto Network Addressing** is turned off, enter a static Control Subnet network address in the **Network** text field. The network address must be in CIDR (Classless Inter-Domain Routing) format that includes the bit mask count after the address (such as "192.168.0.0/24").
- Turn on the **Isolation Mode** toggle to run the Control Subnet in isolation mode. When in isolation mode, the firewall is configured so that no communication can occur between the LAN and devices on the Control Subnet. Using this mechanism, customers can protect their corporate LAN from devices on the Control Subnet. For more information, refer to [Control Subnet on page 238](#).
- Turn on the **Start Program After Router is Online** toggle to start control system programs only after the internal Control Subnet router is reporting online.
- Use the **Port Map** table to create port mapping rules to use with the Control Subnet.

NOTE: No port maps can be added if **Isolation Mode** is turned on.

- Select **Add** to add a new port mapping rule into the table.
- Enter the following information for each entry:
 - Enter the external port in the **External Port** text field. This is the port number that users outside the LAN must specify to connect to the service on the internal network.
 - Enter the internal port in the **Internal Port** text field. This is the port number for the specified service on the internal network.
 - Enter the IP address or host name of the target control system in the **IP Address/Hostname** text field.
 - Use the **Protocol** drop-down menu to specify the connection type that will be accepted from machines outside the LAN.
- To remove an entry, fill the checkbox to the left of the table entry, and then select **Remove**.
- **IPv6 Address with Prefix:** With **IPv6 Enabled** turned on, use the provided table to add IPv6 Control Subnet network addresses to the control system.
 - Select **Add** to add a new IPv6 Control Subnet network address to the control system.
 - Enter the following information for each entry:
 - Enter the IPv6 Control Subnet network address into the **Address** text field.
 - Enter the prefix for the IPv6 Control Subnet network address into the text field following the address.
 - If desired, use the copy button  to copy the IPv6 Control Subnet network address to the clipboard.
 - To remove an entry, fill the checkbox to the left of the table entry, and then select **Remove**.

NOTE: An "x" icon is shown to the right of the IPv6 Control Subnet network address prefix in a table row if the IPv6 address format is invalid or is missing a prefix. Hover over the icon to view a message explaining the issue.

Programs

Select **Programs** to manage control system programs and to configure secondary mode settings for the control system.

Settings Tab - Programs

▼ Programs





























































— Slave Mode

Slave Mode

Master IP/Hostname

Master IP ID

— Programs Slot Management

Slot	Program Name	Registration	Execution	Program Editing	Program Execution
1	No Program Loaded	Unregistered	Stopped	  	  
2	No Program Loaded	Unregistered	Stopped	  	  
3	No Program Loaded	Unregistered	Stopped	  	  
4	No Program Loaded	Unregistered	Stopped	  	  
5	No Program Loaded	Unregistered	Stopped	  	  
6	No Program Loaded	Unregistered	Stopped	  	  
7	No Program Loaded	Unregistered	Stopped	  	  
8	No Program Loaded	Unregistered	Stopped	  	  
9	No Program Loaded	Unregistered	Stopped	  	  
10	No Program Loaded	Unregistered	Stopped	  	  

Secondary Mode

NOTE: For more information on using secondary mode for a 4-Series control system, refer to [Primary-Secondary Mode on page 247](#).

Select the + (plus) icon next to **Secondary Mode** to display the following secondary mode settings.

- Turn the **Secondary Mode** toggle on to run the control system in secondary mode. If this toggle is turned on, the control system will follow a program running on the primary control system and will make its ports available to that control system.
- If **Secondary Mode** is turned on, enter the IP address or host name of the primary control system in the **Primary IP/Hostname** text field.
- If **Secondary Mode** is turned on, enter the IP ID for the connection to the primary control system in the **IP ID** text field.

Program Slot Management







NOTE: For more information on managing programs on a 4-Series control system, refer to [Program Management on page 242](#).

Select the + (plus) icon next to **Program Slot Management** to display the following program management settings.

Each program slot is represented in a table that provides the following information and controls:

- **Slot:** The program slot number (1-10)

NOTE: The MC4, MC4-I, and RMC4 are designed to run a single program out of the box. The optional modular programming architecture (MPA) add-on allows the RMC4 to run up to ten programs simultaneously via a [SW-RMC3-10PROG](#) license.

- **Program Name:** The name for the control system program
- **Registration:** The registration status of the program
- **Execution:** The execution status of the program
- **Program Editing:** Provides the following program editing controls:
 - Select the **Upload Program** button  to load a new program to the control system. Instructions for loading a new program to the control system are provided below.
 - Select the **Edit Program** button  to edit information about the program (if available).
 - If the program is unregistered, select the **Register Program** button  to register the program with the control system.
 - If the program is registered, select the **Unregister Program** button  to unregister the program from the control system.
- **Program Execution:** Provides the following program execution controls:
 - If the program is stopped, select the **Start Program** button  to start the program.
 - If the program is running, select the **Stop Program** button  to stop the program.
 - Select the **Restart Program** button  to restart the program.

Load a New Program

To load a new program to the control system:

1. Select the **Upload Program** button  in an available program slot. The **Add Program** dialog box is displayed.

Add Program Dialog Box

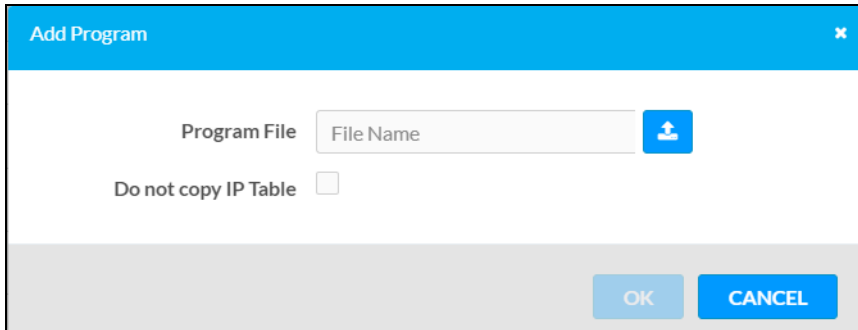

2. If desired, fill the **Do not copy IP Table** check box to prevent the program IP table from being copied to the control system following the upload.
3. Select the **Program File** button. The **File Upload** dialog box is displayed.

File Upload Dialog Box

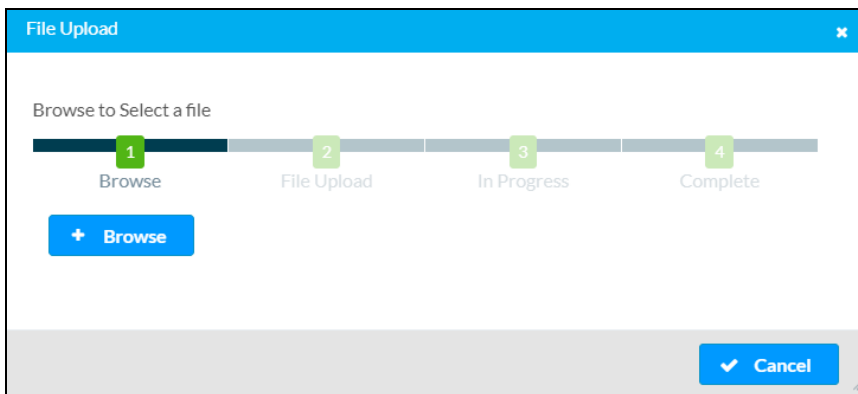

4. Select **Browse**, and then navigate to the program file (LPZ or CPZ) on the host computer.
5. Select the program file, and then select **Open**.
6. Select **Load** to load the program file to the control system. The upload progress is shown in the dialog box.
7. Once the control system has completed the program upload, select **OK**. The program will appear in the **Program Slot Management** table and will automatically try to register and start itself on the control system.

Edit a Program

To edit the IP table for a control system program (if permitted by the program):

1. Select the **Edit Program** button  in the desired program slot. The **Edit Program** dialog box is displayed.

Edit Program Dialog Box

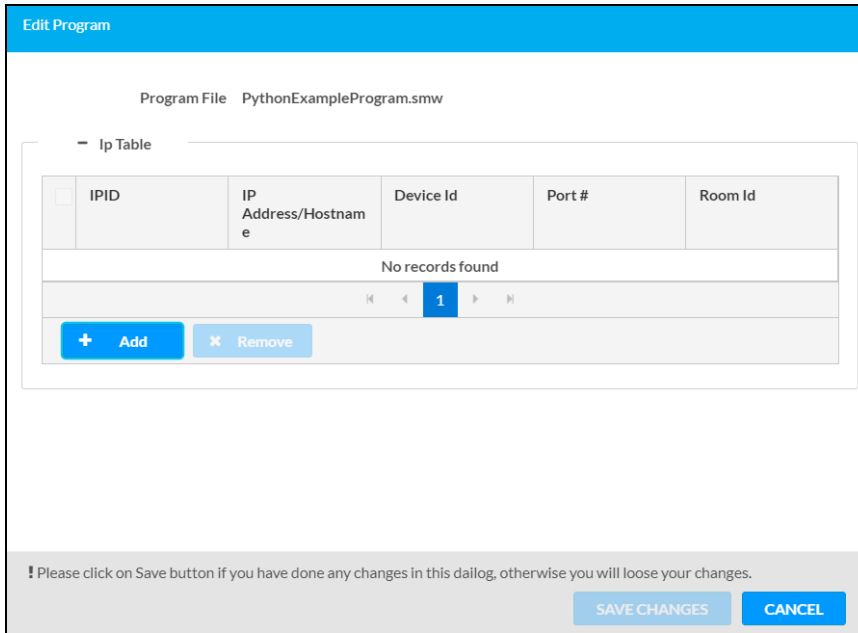

The screenshot shows the 'Edit Program' dialog box for the file 'PythonExampleProgram.smw'. It features a section titled 'Ip Table' which contains a table with the following columns: IPID, IP Address/Hostname, Device Id, Port #, and Room Id. The table is currently empty, displaying 'No records found' and a page indicator '1'. Below the table are 'Add' and 'Remove' buttons. At the bottom of the dialog, there is a warning message: '! Please click on Save button if you have done any changes in this dialog, otherwise you will loose your changes.' and two buttons: 'SAVE CHANGES' and 'CANCEL'.

NOTE: If IP table entries have already been defined in the program, these entries will populate the table in the **Edit Program** dialog box unless the **Do not copy IP Table** check box was filled when loading the program to the control system.

2. Select **Add** to add a new IP table entry for the program (if necessary).
3. Enter or update the following information in each column for the IP table entry:
 - **IPID:** Enter an IP ID that will be used for communication between a device and the control system.
 - **IP Address/Hostname:** Enter the IP address or host name for the device that will connect to the control system over IP.
 - **Device Id:** Enter a unique ID for the connecting device. By default, this value is the same as the provided IP ID.
 - **Port #:** Enter the port used for communication between device and control system.
 - **Room Id:** Enter the Crestron Virtual Control (VC-4) room ID that is associated with the IP table entry. This setting is applicable only for VC-4 connections.
4. Select **Save Changes** to save any changes to the IP table.

Projects

Select **Projects** to manage web and mobility projects for the control system.

Settings Tab - Programs

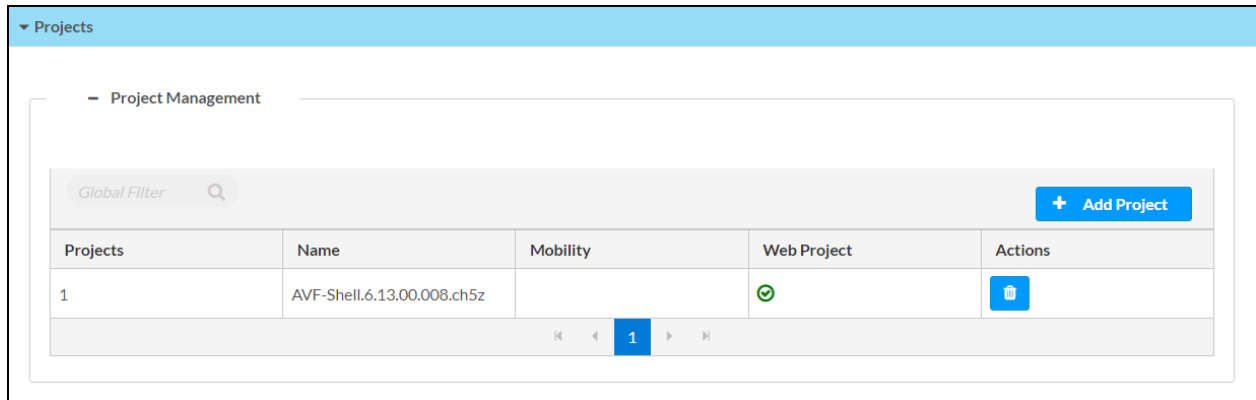

Projects	Name	Mobility	Web Project	Actions
1	AVF-Shell.6.13.00.008.ch5z		✓	

Each loaded project is represented in a table that provides the following information and controls:

- **Projects:** The project number on the control system
- **Name:** The name for the web or mobility project
- **Mobility:** Displays a green check icon if the project is a mobility project
- **Web Project:** Displays a green check icon if the project is a web project
- **Actions:** Select the trash can button  to delete the project from the control system

To load a new web or mobility project to the control system:

1. Select **Add Project**. The **Add Project** dialog box is displayed.

Add Project Dialog Box

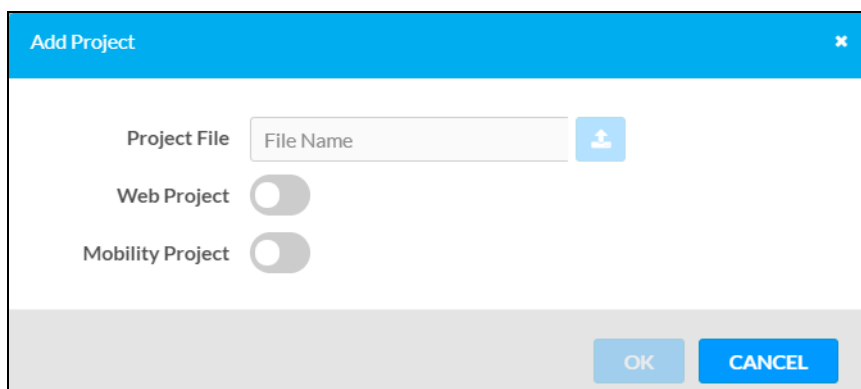

Add Project [X]

Project File 

Web Project

Mobility Project

OK CANCEL

2. Turn on the **Web Project** or **Mobility Project** toggles to define whether the loaded project is a web or a mobility project.

NOTE: If the project is both a web and a mobility project, both toggles can be selected.

3. Select the **Project File** button. The **File Upload** dialog box is displayed.

File Upload Dialog Box

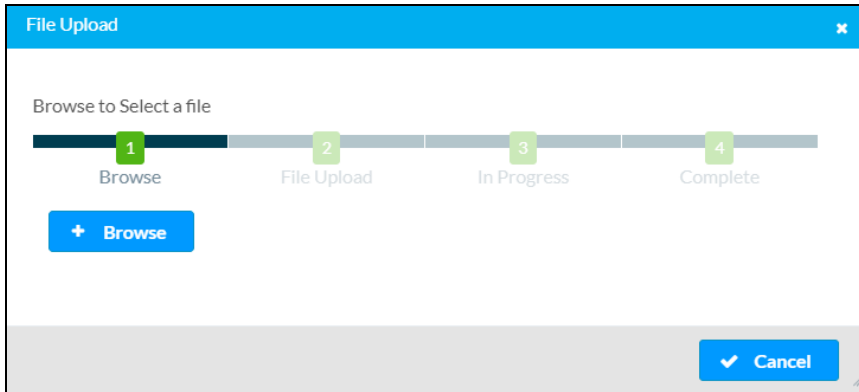

4. Select **Browse**, and then navigate to the project file on the host computer.
5. Select the project file, and then select **Open**.
6. Select **Load** to load the project file to the control system. The upload progress is shown in the dialog box.
7. Once the control system has completed the project upload, select **OK**. The program will appear in the **Project Management** table.

Services

Select **Services** to manage various external services that integrate with the control system.

Settings Tab - Services

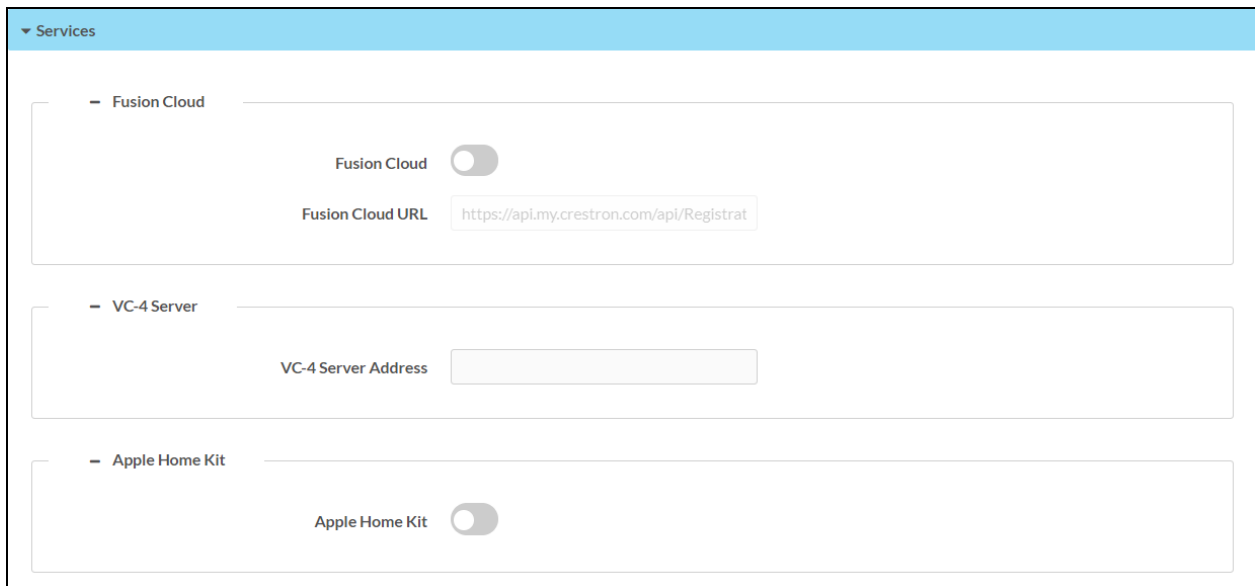

Crestron Fusion Cloud

NOTE: If connecting to a Crestron Fusion software on-premises server, connections are made using either traditional (outbound) or inbound communications. For more information, refer to the [Crestron Fusion 10 On-Premises Software Getting Started Guide](#).

- Turn on the **Crestron Fusion Cloud** toggle to allow a connection to a Crestron Fusion Cloud server.
- If **Crestron Fusion Cloud** is turned on, enter the address used to connect the control system to the desired Crestron Fusion Cloud server in the **Crestron Fusion Cloud URL** text field.

VC-4 Server

NOTE: For more information on connecting the control system to Crestron Virtual Control (VC-4), refer to the help file in the Crestron Virtual Control web configuration interface. To access the help file, select the question mark button  on the top left of the page.

Enter a VC-4 server address into the **VC-4 Server Address** text field to establish a connection between the control system and a VC-4 server.

Apple HomeKit

NOTE: For more information on pairing the device with an Apple® HomeKit® system, refer to support.apple.com/en-us/HT204893.

Turn on the **Apple Home Kit** toggle to turn on the HomeKit feature on the control system. For more information, refer to [Pairing a 4-Series Control System with Apple HomeKit Technology on page 265](#).

Cloud Settings

Select **Cloud Settings** to turn a connection between the control system and an XiO Cloud® service account on or off.

Settings Tab - Cloud Settings

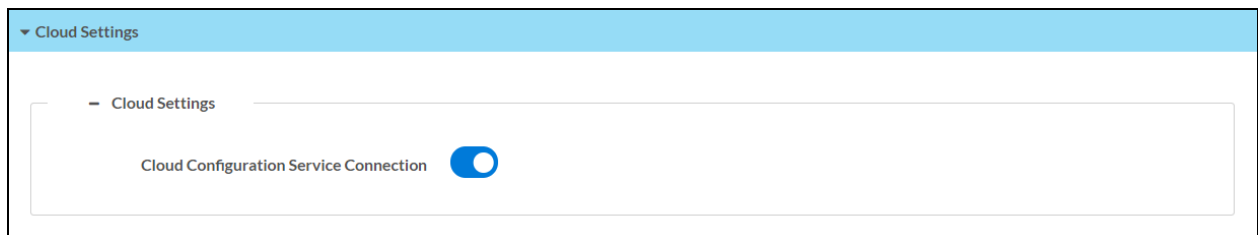

Turn on the **Cloud Configuration Service Connection** to allow a connection between control system and an XiO Cloud account. This setting is turned on by default.

For more information on connecting to the XiO Cloud service, refer to [XiO Cloud Service on page 154](#).

Auto Update

Select **Auto Update** to configure automatic firmware updates for the control system and connected devices.

Settings Tab - Auto Update

The screenshot shows the 'Auto Update' settings page. It is divided into four sections:

- General:** Features a toggle for 'Auto Update' which is currently turned on. Below it is a 'Custom URL' text field containing the value 'ftp://username:password@host:port/path'.
- Server:** Contains two text input fields: 'Username' and 'Password' (masked with dots).
- Crestron Devices:** Also contains two text input fields: 'Username' and 'Password' (masked with dots).
- Schedule:** Includes a 'Day of Week' dropdown menu set to 'None', a 'Time of Day' text field set to '00:00', and a 'Poll Interval' text field set to '0' with the unit 'Minutes' indicated. A blue 'Update Now' button is positioned at the bottom of this section.

NOTE: For more information on configuring automatic updates for the control system, refer to [Auto Update Mechanism on page 251](#).

General

- Turn on the **Auto Update** toggle to use automatic updates for the control system and connected devices.
- If **Auto Update** is turned on, enter a custom update server FTP address in the **Custom URL** text field.

Server

The following settings can be configured for the auto update server if **Auto Update** is turned on:

- Enter a username for accessing the auto update server in the **Username** text field.
- Enter a password for accessing the auto update server in the **Password** text field.

Crestron Devices

The following settings can be configured for updating connected Crestron devices if **Auto Update** is turned on:

- Enter a username for pushing automatic updates to controlled Crestron devices in the **Username** text field.
- Enter a password for pushing automatic updates to controlled Crestron devices in the **Password** text field.

Schedule

The following settings can be configured for scheduling automatic updates if **Auto Update** is turned on:

- Use the **Day of Week** drop-down menu to select a day of the week to check for and perform automatic updates.
 - Select **Daily** to check for new updates every day.
 - Select **None** to only check for new updates manually.
- If a value is provided for **Day of Week** other than "None," enter a time of day (in 24-hour format) when the control system will check updates on the scheduled day in the **Time of Day** text field.
- If "None" is selected for **Day of Week**, enter the polling interval (in minutes) for when the control system will poll the server for updates in the **Poll Interval** text field.
- Select **Update Now** to check the update server for new firmware and to update the control system immediately if new firmware is available.

AV Framework

Select **AV Framework** to configure the native .AV Framework software program running on the control system.

Settings Tab - AV Framework

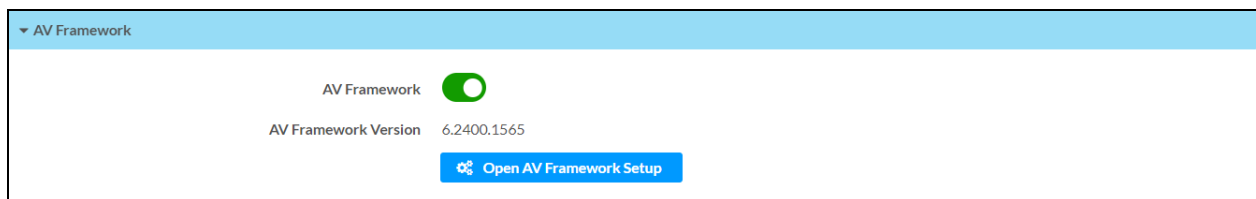

NOTE: If an older version of the .AV Framework program is detected in the Program 01 slot (6.13 and prior), the program is loaded to the Program 00 slot, but it is not turned on within

the control system. The older .AV Framework program must be removed manually before the newer version can be turned on. For more information, refer to the [.AV Framework Software for 4-Series Control Systems Operations Guide](#).

- Turn on the **AV Framework** toggle to turn on the native .AV Framework software program on the control system.
- If **AV Framework** is turned on, the version of the native .AV Framework software program is reported next to **AV Framework Version**.
- If **AV Framework** is turned on, select **Open AV Framework Setup** to launch the .AV Framework web configuration utility. For more information on configuring .AV Framework for the control system, refer to the [.AV Framework Software for 4-Series Control Systems Operations Guide](#).

Security

Select the **Security** tab on the top left of the configuration interface to display selections for configuring security and authentication settings for the control system.

Security Tab Selections

The screenshot shows the Security configuration interface. At the top, there are navigation tabs: Status, Settings, Security (selected), and 802.1x Configuration. Below the tabs is a blue header bar with a dropdown arrow and the text 'Security'. The main content area contains the following elements:

- SSL Mode:** A dropdown menu currently set to 'Encrypt'.
- SSL Authentication:** A section containing three input fields: 'Username', 'Password', and 'Confirm Password', all of which are currently empty.
- Enable User Page Authentication:** A toggle switch that is currently turned off.
- Current User:** A section with a dark header bar containing 'Current User', 'Users', and 'Groups' tabs. Below the header, the following information is displayed:
 - Name: ihammons1
 - Access Level: Administrator
 - Active Directory User: No
 - Groups: AdministratorsA blue button labeled 'Change Current User Password' is located at the bottom left of this section.

Expand the **Security** accordion to configure the following settings:

NOTE: For more information about configuring authentication settings on a 4-Series control system, refer to [Authentication on page 210](#).

- **SSL Mode:** Select an SSL (Secure Sockets Layer) mode to use for establishing a secure connection to the control system:
 - **Encrypt and Validation:** The control system will require a username and password to validate an encrypted SSL connection. Enter a username and password in the appropriate fields that are displayed.
 - **Encrypt:** The control system will use an encrypted SSL connection.
- **Enable User Page Authentication:** Turn on the toggle to use user page authentication for web pages and mobility projects. If this toggle is turned on, a user will be prompted for login credentials as they load the project.

Control system users and groups can be viewed and modified within the table provided at the bottom of the accordion. Use the following settings to add, delete, and edit control system users and groups.

Current User

Select the **Current User** tab to view and edit information for the current control system user.

Current User Tab

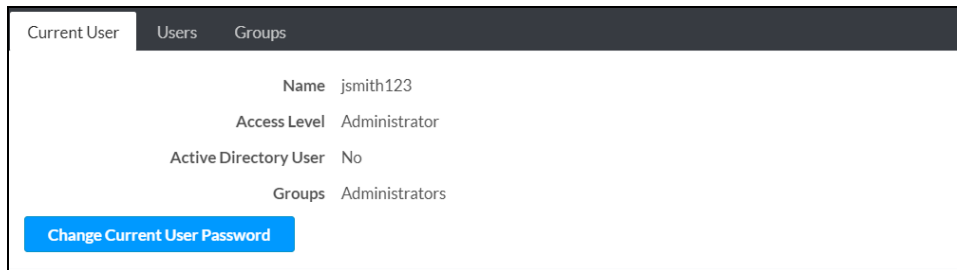

The screenshot shows a web interface with three tabs: 'Current User', 'Users', and 'Groups'. The 'Current User' tab is active. Below the tabs, the following user information is displayed:

Name	jsmith123
Access Level	Administrator
Active Directory User	No
Groups	Administrators

At the bottom of the tab content, there is a blue button labeled 'Change Current User Password'.

The following settings are displayed for the current user:

- **Name:** The chosen username
- **Access Level:** The access level granted to the user (**Administrator**, **Programmer**, **Operator**, **User**, or **Connect**)
- **Active Directory User:** Reports whether the current user is (**Yes**) or is not (**No**) authenticated through Active Directory® software

NOTE: A user must be added to an Active Directory group before the user may be selected as an active directory user. For more information, refer to [Groups on page 193](#).

- **Groups:** Any groups of which the current user is a member

Select **Change Current User Password** to change the password for the current user. The **Change Password** dialog box is displayed.

Change Password Dialog Box

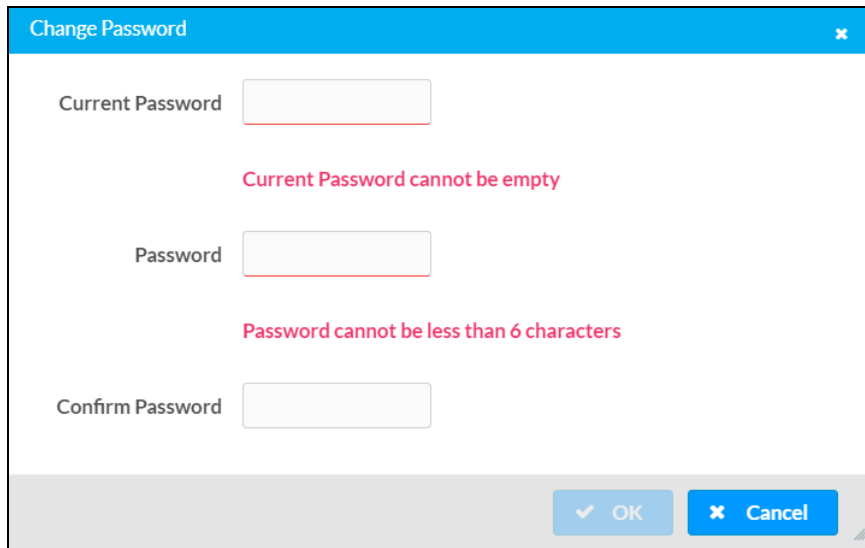

The dialog box has a blue title bar with the text "Change Password" and a close button (X). It contains three text input fields: "Current Password", "Password", and "Confirm Password". Below the "Current Password" field is a red error message: "Current Password cannot be empty". Below the "Password" field is a red error message: "Password cannot be less than 6 characters". At the bottom right, there are two buttons: "OK" (with a checkmark icon) and "Cancel" (with an X icon).

Enter the existing password in the **Current Password** field. Then, enter a new password in the **Password** field, and reenter the password in the **Confirm Password** field.

Select **OK** to save the new password, or select **Cancel** to cancel the change.



Users

Select the **Users** tab to view and edit information for the control system users.

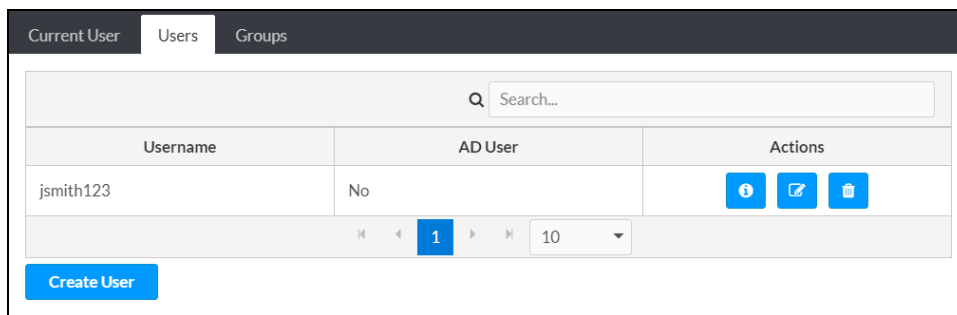
Users Tab



The interface shows three tabs: "Current User", "Users", and "Groups". The "Users" tab is active. It features a search bar with a magnifying glass icon and the text "Search...". Below the search bar is a table with the following columns: "Username", "AD User", and "Actions". The table contains one row with the following data: "jsmith123", "No", and three action icons (info, edit, delete). Below the table is a pagination bar showing "1" of "10" items. At the bottom left, there is a "Create User" button.

Username	AD User	Actions
jsmith123	No	  

Enter text into the **Search Users** field to find and display users that match the search term(s).

Control system users are listed in table format. The following information is displayed for each control system user:

- **Username:** The chosen username
- **AD User:** Reports whether the user is (**Yes**) or is not (**No**) authenticated through Active Directory

NOTE: A user must be added to an Active Directory group before the user may be selected as an active directory user. For more information, refer to [Groups on page 193](#).

If the control system users span multiple pages, use the navigation arrows on the bottom of the page to move forward or backward through the pages, or select a page number to navigate to that page. Additionally, the number of users displayed on each page may be set to 5, 10, or 20 users.

An **Actions** column is also provided for each user that allows various actions to be performed. The following selections may be selected from the **Actions** column.

User Details

Select the information button  in the **Actions** column to view information for the selected user. The **User Details** pop-up dialog box is displayed.

User Details Dialog Box

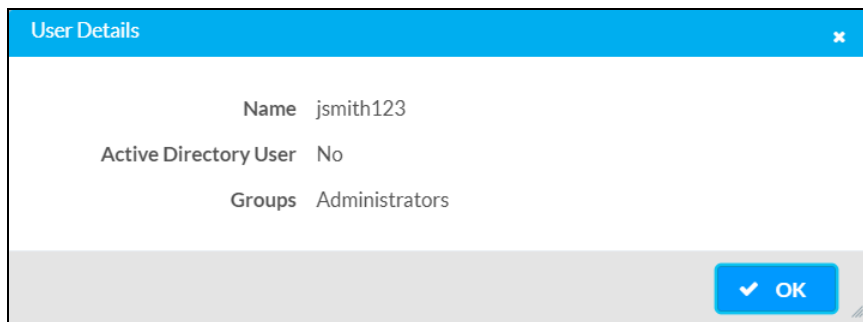

The following settings are displayed for the current user:

- **Name:** The chosen username
- **Active Directory User:** Reports whether the user is (**Yes**) or is not (**No**) authenticated through Active Directory
- **Groups:** Lists any groups that contain the user

Select **OK** to return to the **Authentication Management > Users** page.

Update User

Select the editing button  in the **Actions** column to edit settings for the selected user. The **Update User** dialog box is displayed.

Update User Dialog Box

The screenshot shows a dialog box titled "Update User". It contains the following fields and controls:

- Name:** jsmith123
- Active Directory User:** A toggle switch that is currently turned off.
- Password:** An empty text input field.
- Error Message:** "Password cannot be less than 6 characters" (displayed in red text below the password field).
- Confirm Password:** An empty text input field.
- Groups:** A dropdown menu with "Administrators" selected.
- Buttons:** "OK" and "Cancel" buttons at the bottom right.

The following **Update User** settings may be viewed or configured:

- **Name:** The chosen username
- **Active Directory User:** Turn on the toggle to use authentication via Active Directory for the selected user.
- **Password:** Enter a new password for the selected user.
- **Confirm Password:** Reenter the password provided in the **Password** field.
- **Groups:** Add the user to one or more groups. For more information, refer to [Groups on page 193](#).

NOTE: A user must be added to an Active Directory group to be selected as an Active Directory user.

Select **OK** to save any changes and to return to the **Users** selections. Select **Cancel** to cancel any changes.

Delete User

Select the trashcan icon  in the **Actions** column to delete the user.

A pop-up dialog box is displayed asking whether the user should be deleted. Select **Yes** to delete the user or **No** to cancel.

Create User

Select **Create User** at the bottom of the page to create a new control system user. The **Create User** dialog box is displayed.

Create User Dialog Box

The screenshot shows a 'Create User' dialog box with the following elements:

- Name:** A text input field with a red error message: "Username cannot be empty".
- Active Directory User:** A toggle switch that is currently turned off.
- Password:** A text input field with a red error message: "Password cannot be less than 6 characters".
- Confirm Password:** A text input field.
- Groups:** A dropdown menu with 'Choose' selected and a red error message: "Group Must be selected".
- Buttons:** 'OK' and 'Cancel' buttons at the bottom right.

Use the following settings to create a new user:

- **Name:** Enter a username.
- **Active Directory User:** Turn on the toggle to use authentication via Active Directory for the user.
- **Password:** Enter a password for the user.
- **Confirm Password:** Reenter the password provided in the **Password** field.
- **Groups:** Add the user to one or more groups. For more information, refer to [Groups on page 193](#).

NOTE: A user must be added to an Active Directory group to be selected as an Active Directory user.

Select **OK** to save any changes and to return to the **Users** selections. Select **Cancel** to cancel creating a new user.







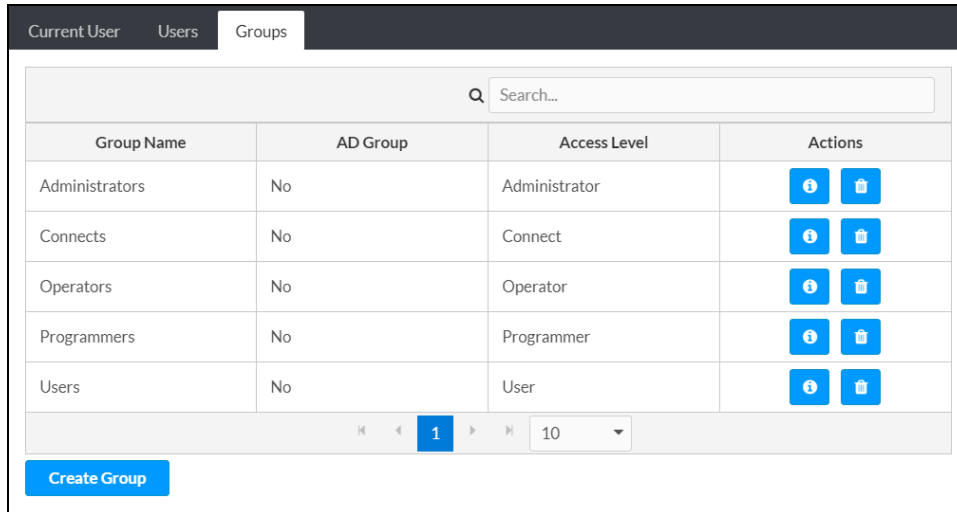



Groups

Select the **Groups** tab to view and edit settings for control system groups. Control system groups are used to group users by access level and Active Directory authentication settings.

Groups Tab



The screenshot shows the 'Groups' tab in a software interface. At the top, there are tabs for 'Current User', 'Users', and 'Groups'. Below the tabs is a search bar with a magnifying glass icon and the text 'Search...'. The main content is a table with four columns: 'Group Name', 'AD Group', 'Access Level', and 'Actions'. The table lists five groups: Administrators, Connects, Operators, Programmers, and Users. Each group has an 'AD Group' of 'No' and an 'Access Level' corresponding to its name. The 'Actions' column contains two blue icons for each group: an information icon and a trash icon. At the bottom of the table, there are navigation arrows, a page number '1', and a dropdown menu set to '10'. A 'Create Group' button is located at the bottom left of the interface.

Group Name	AD Group	Access Level	Actions
Administrators	No	Administrator	 
Connects	No	Connect	 
Operators	No	Operator	 
Programmers	No	Programmer	 
Users	No	User	 

Enter text in the **Search Groups** field to find and display groups that match the search term(s).

Control system groups are listed in table format. The following information is displayed for each control system group:

- **Group Name:** The chosen group name
- **AD Group:** Reports whether the group is (**Yes**) or is not (**No**) authenticated through Active Directory

NOTE: Active Directory provides an extra layer of authentication for control system groups and users. Active directory group and user names are stored in the control system console along with a unique SID (security identifier). When an Active Directory user attempts to authenticate against the console, the console first checks the user credentials. If the Active Directory authentication is successful, Active Directory queries the console for the user or group's SID. The user is granted access to the control system only if at least one SID match is found.

- **Access Level:** The access level for the selected group (**Administrator, Programmer, Operator, User, or Connect**)

If the control system groups span multiple pages, use the navigation arrows on the bottom of the page to move forward or backward through the pages, or select a page number to navigate to that page. Additionally, the number of groups displayed on each page may be set to 5, 10, or 20 users.

An **Actions** column is also provided for each group that allows various actions to be performed. The following selections may be selected from the **Actions** column.

Group Details

Select the information button  in the **Actions** column to view information for the selected group. The **Group Details** dialog box is displayed.

Group Details Dialog Box

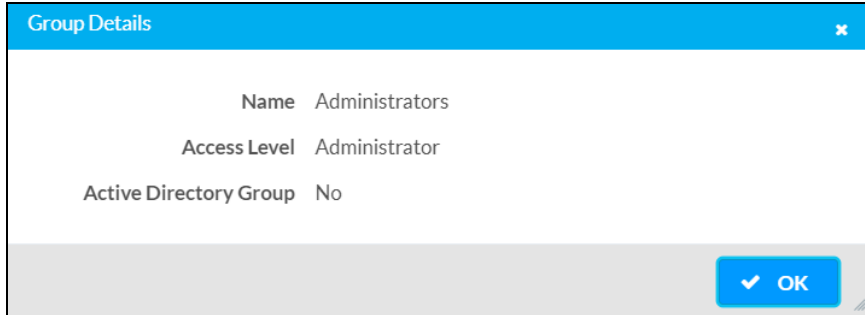

The following settings are displayed for the current group:

- **Name:** The chosen group name

NOTE: If authenticating with Active Directory, do not enter the domain name for the Active Directory group in the **Name** field. If this information is being entered via console commands, omit `domain\local` from the command (for example, `adddomaing -n:crestron -L:A` instead of `adddomaing -n:domain.local\crestron -L:A`).

- **Access Level:** The access level of the group and its users
- **Active Directory User:** Reports whether the group is (**Yes**) or is not (**No**) authenticated through Active Directory

Select **OK** to return to the **Groups** selections.

Delete Group

Select the trashcan icon  in the **Actions** column to delete the group.

A pop-up dialog box is displayed asking whether the group should be deleted. Select **Yes** to delete the group or **No** to cancel.

Create Group

Select **Create Group** at the bottom of the page to create a new control system group. The **Create Group** dialog box is displayed.

Create Group Dialog Box

Create Group

Name

Group Name field cannot be empty

Access Level Administrator

Active Directory Group

✓ OK ✕ Cancel

Use the following settings to create a new group:

- **Name:** Enter a group name.
- **Access Level:** Select an access level for the group and its users from the drop-down menu.
- **Active Directory Group:** Turn on the toggle to use authentication via Active Directory for the group.

Select **OK** to save any changes and to return to the **Groups** selections. Select **Cancel** to cancel creating a new group.

802.1x Configuration

Select the **802.1x Configuration** tab on the top left of the configuration interface to display selections for configuring IEEE 802.1X network authentication for control system security.

802.1x Configuration Tab Selections

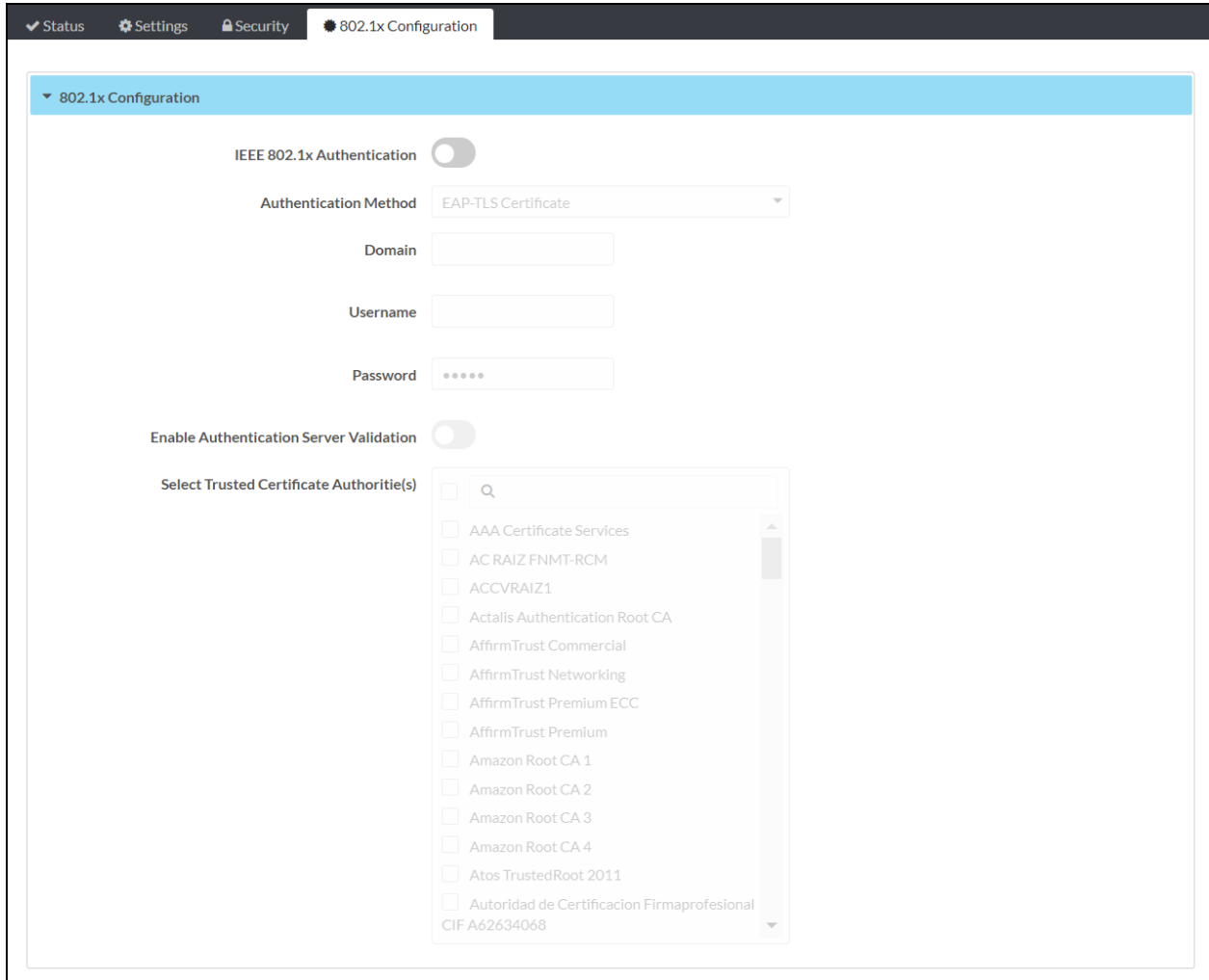

Expand the **802.1x Configuration** accordion to configure the following settings:

NOTE: For more information about configuring 802.1X network authentication on a 4-Series control system, refer to [802.1X on page 230](#).

- **IEEE 802.1x Authentication:** Turn on the toggle to use 802.1X authentication for the control system.

- **Authentication Method:** Select an 802.1X authentication method (**EAP-TLS Certificate** or **EAP MSCHAP V2- password**) from the drop-down menu.
 - **Domain:** If **EAP MSCHAP V2- password** is selected for **Authentication Method**, enter a domain name that is required for authentication.
 - **Username:** If **EAP MSCHAP V2- password** is selected for **Authentication Method**, enter a username that is required for authentication.
 - **Password:** If **EAP MSCHAP V2- password** is selected for **Authentication Method**, enter a password that is required for authentication.
- **Enable Authentication Server Validation:** Turn on the toggle to use server validation for increased security.
- **Select Trusted Certificate Authorities:** Select trusted CAs (Certificate Authorities) from the provided CAs to be used for server validation:
 - Select the check box to the left of a CA to select it as a trusted CA.
 - Enter a search term into the text field at the top of the CA menu to search for and display CAs that match the search term.
 - Select the check box to the left of the search field at the top of the CA menu to select all CAs as trusted CAs.

Select **Manage Certificates** from the **Action** menu to add or remove CAs from the list. The **Manage Certificates** dialog box is displayed with the **Root** tab selected.

Manage Certificates Dialog Box - Root Tab

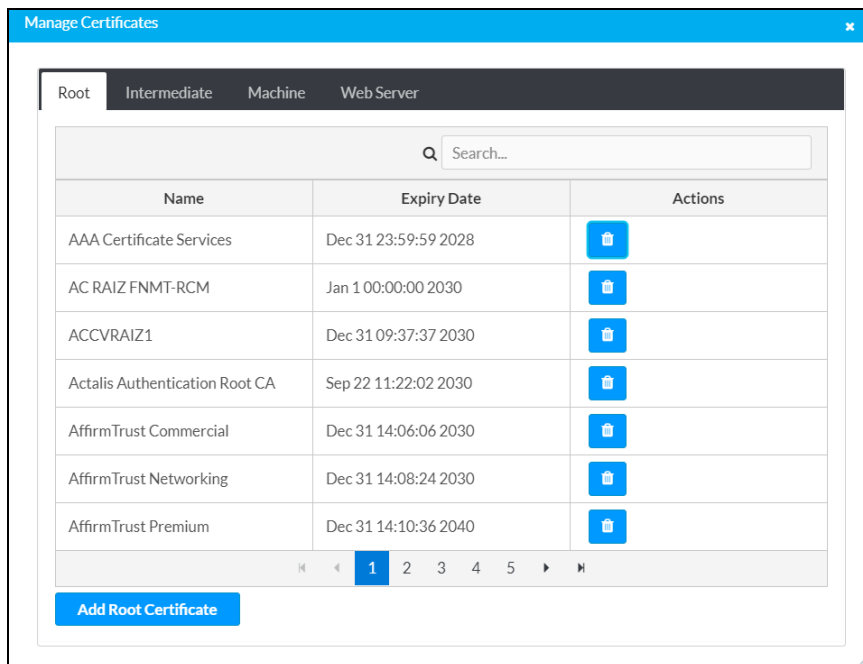

Select the tabs near the top of the page to switch between the different types of CAs (**Root**, **Intermediate**, **Machine**, or **Web Server**). The same settings are provided for each type of CA.

Type a search term into the **Search...** text field to search for and display CAs that match the search term.

The following information is provided for each type of CA:

- **Name:** The CA name
- **Expiry Date:** The date and time that the CA is set to expire

If the CAs span multiple pages, use the navigation arrows on the bottom of the page to move forward or backward through the pages, or select a page number to navigate to that page.

Select the trashcan button  in the **Actions** column for a CA to delete it. A pop-up dialog box is displayed asking if the CA should be deleted. Select **Yes** to delete the certificate or **No** to cancel.

Select **Add [Type] Certificate** to add a CA of one of the four available types (**Root**, **Intermediate**, **Machine**, or **Web Server**) to the list of CAs. The **Add Certificate** pop-up dialog box is displayed.

Add Certificate Dialog Box

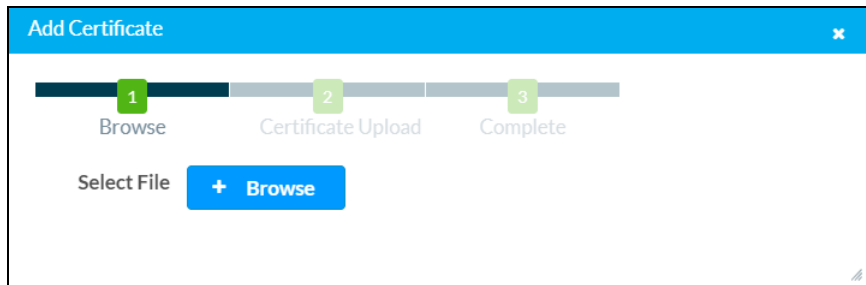

To add a new certificate:

1. Select **Browse**.
2. Navigate to the CA file on the host computer.
3. Select the CA file, and then select **Open**.
4. Select **Load** to load the CA file to the control system. The upload progress is shown in the dialog box.
5. Once the control system has completed the upload, select **OK**.

Select the **x** button to close the **Add Certificate** dialog box at any time during the upload process. Selecting the **x** button before the CA file is uploaded to the control system cancels the upload.

Select the **x** button to close the **Manage Certificates** dialog box and to return to the **802.1x Authentication** page.

Programming

4-Series control systems support an open development environment that enables programmers to use standard tools to create C# programs. Programmers can also use Crestron tools such as [SIMPL](#), [SIMPL# Pro](#), and [VT Pro-e](#)® software to create control system programs and projects.

NOTE: Custom programming is not supported on Crestron Home® OS control systems.

- For more information on programming for a 4-series control system using C#, refer to [online help answer ID 1000637](#).
- For more information on programming for a 4-series control system using the Python® programming language, refer to the [Python Programming Language on 4-Series Control Systems Developer Microsite](#).

Reference Topics

The following topics provide detailed reference information for 4-Series control systems.

NOTE: Certain reference topics are not applicable to Crestron Home® OS control systems and Crestron Virtual Control server-based control systems.

- [Tools and Utilities on page 201](#)
- [4-Series Architecture on page 202](#)
- [Establish Communications on page 205](#)
- [Time and Date Settings on page 209](#)
- [Authentication on page 210](#)
- [Certificate Management on page 221](#)
- [802.1X on page 230](#)
- [Message Logging on page 233](#)
- [Control Subnet on page 238](#)
- [Program Management on page 242](#)
- [Primary-Secondary Mode on page 247](#)
- [Auto Update Mechanism on page 251](#)
- [Restore to Factory Defaults on page 263](#)
- [Port Forwarding on page 264](#)

Tools and Utilities

Standard IT tools, such as SFTP (secure file transfer protocol) clients and SSH (secure shell) clients, can be used to perform various control system tasks and functions. Many configuration tasks can also be performed using the web configuration interface as described in [Web Configuration on page 160](#).

Additionally, the following Crestron tools and utilities may be used to program and configure the control system:

- Crestron Toolbox™ software
- SIMPL Debugger tool
- SIMPL software
- SIMPL# Pro software
- VT-Pro e® software

NOTE: 4-Series control systems support programming outside of the sandbox using third-party tools. For more information, refer to [online help article 1000637](#).

All tools and utilities may be downloaded from www.crestron.com/Support. For more information on the features and functions of each tool, refer to its embedded help file.

NOTE: Access to software downloads and other files is reserved for Authorized Crestron dealers, Crestron Service Providers (CSPs), and Crestron partners only. New users must register for an account to access certain areas of the Crestron website. For more information on registering, refer to www.crestron.com/register.

4-Series Architecture

The following sections provide an overview of the architecture of a 4-Series control system.

Memory and Directory Structure

A 4-Series processor has between 1 GB and 2 GB of built-in SDRAM (synchronous DRAM) volatile memory. For more information regarding the memory specifications for each 4-Series control system model, refer to [Features on page 2](#).

The file system inside the 4-Series control engine is contained within Flash memory. The 4-Series processor also has 128kB of NVRAM (nonvolatile RAM). NVRAM contains program variables that are retained after the loss of electrical power, while volatile memory is lost.

Flash Memory

Flash memory for a 4-Series control system contains the following components:

- Operating system (.puf file)
- SIMPL and SIMPL# Pro programs
- SIMPL+® programming modules

The files that reside in flash memory conform to a flat directory structure. The following table details the overall file system as shown over SNTP. The internal file path is also provided where applicable.

NOTE: Directory names are case-sensitive on 4-Series control systems.

4-Series Control System Directory Structure

SFTP File Path	Internal File Path	Description
\auditlog	(N/Ap)	Contains the output of the audit log files
\autoupdatelogs	\sys\AutoUpdate\Log	Contains the output of the autoupdate log files
\cert	\romdisk\user\cert	Contains any user certificates loaded to the control system
\firmware	\romdisk\user\system	Contains firmware files (PUF or ZIP) loaded to the control system
\html	\html	Contains web pages
\nvram	\nvram	The NVRAM legacy directory
\plog	\logs	Contains the output of the persistent log (PLOG) files
\rm, \rm2	\rm, \rm2	A mounting point for external removal media

SFTP File Path	Internal File Path	Description
\programxx	\simpl\programxx	The control system program files (where xx is the program number)
\sshbanner	\sshbanner	Contains a custom SSH banner text file loaded to the control system
\temp	(N/Ap)	Contains any temp files used by the control system
\user	\user	Contains any user-defined files loaded to the control system

The directory structure of a 4-Series control system can reside on the internal flash memory and on optional external memory (SD/SDHC). Programs, data files, and data can be stored on either internal or external memory. The files that reside in the internal flash conform to a flat directory structure, while the external memory system conforms to a FAT32 compatible file system.

NOTE: Although file system names are case insensitive, the case is preserved to maintain file checksums.

Observe the following about external media directories:

- The **rm** and **rm2** directories appear only when external removable media is inserted into the control system. To reference files in external memory, prefix "\rm\" or "\rm2\" to any fully qualified path from the computer OS environment.
- When a SIMPL or SIMPL# Pro program is stored in external memory, the files reside in the `\rm[2]\programxx\` directory, where "xx" is the program number.
- When web pages are stored in external memory, the pages reside in the `\rm[2]\html\` directory.
- Storing programs and web pages in external memory gives them precedence over files stored in internal flash memory. For example, if different programs are stored in both internal flash and external memory, the program in external memory will run when the system is booted.

SDRAM (Volatile)

Volatile SDRAM is used by the operating system to dynamically store the following components:

- Digital and analog signal values
- SIMPL+ variables (default is no options are specified, or if using "volatile" qualifier or #DEFAULT_VOLATILE)

The actual amount of SDRAM used at any given time depends on the program that is running; therefore, usage is variable (dynamic) during normal operation.

NVRAM (Nonvolatile)

Nonvolatile NVRAM contain the following components:

- SIMPL+ variables (if "volatile" qualifier or #DEFAULT_VOLATILE is removed)
- Signals explicitly written to NVRAM (such as Analog RAM, Analog RAM from database, Serial RAM, Serial RAM from database, Analog nonvolatile ramp, Digital RAM, and so forth)

NOTE: SIMPL# Pro has no access to the NVRAM. Programmers should write files for persistent variables instead.

Console Commands

The 4-Series processor is capable of understanding and responding to a set of phrases known as console commands. Console commands are used to configure the control system.

Observe the following about console commands:

- Console commands can be sent to the device using an SSH client over its IP address or host name. Console commands may also be sent to the device using the **Text Console** tool in Crestron Toolbox via one of the supported communication protocols.
- Console commands are grouped logically. Issuing the `help` command from the console responds with various command categories.
- Issuing the `help all` command responds with a list of all exposed console commands for the device.
- The same command may be listed in more than one category. Commands are case insensitive and can be entered from the appropriate prompt.
- To view the available options and parameters for a command, issue the command followed by a space and "?" (for example, `iptable ?`).
- Support for new console commands is added via firmware updates. Refer to the firmware release notes for more information.

Establish Communications

The control system must establish communications with a computer in order to upload programs, troubleshoot, or perform diagnostics.

NOTE: The user must create an admin account username and password after connecting to the device for the first time. For more information, refer to [Authentication on page 210](#).

Depending on the control system capabilities, the following communication protocols may be used to connect with a 4-Series control system:

- USB communication with a PC via the **COMPUTER** port on the control system (requires Crestron Toolbox software)
- Ethernet communication via SSH

USB Connection

To connect to the control system via USB:

1. Connect the **COMPUTER** USB port of the control system to the USB port of a computer.
2. Open Crestron Toolbox software.
3. Select the pencil icon  at the bottom left of any tool in Crestron Toolbox. A dialog box for editing the connection type is displayed.
4. Select the **USB** radio button.

Connection Type Dialog Box - USB

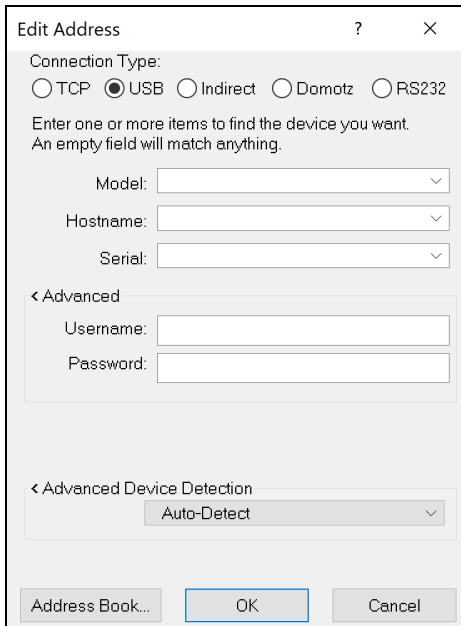

Dialog box titled "Edit Address" showing connection type options (TCP, USB, Indirect, Domatz, RS232) and fields for Model, Hostname, Serial, Username, Password, and Advanced Device Detection (Auto-Detect).

5. Enter the following search parameters for the device (required only if multiple USB connections are active):
 - **Model:** Enter the model name of the Crestron device (for example, PRO4). The model is not user-defined. It is the actual model name of the device as displayed in the **EasyConfig** tool.
 - **Hostname:** Enter the device host name.
 - **Serial:** Enter the serial number (not the model number or TSID) of the Crestron device. The serial number is a 12-digit number (not beginning with 60 or 65) that may contain letters. The serial number is printed on a sticker affixed to the device and is displayed in the **EasyConfig** tool.
6. Enter the following advanced authentication parameters for the device:
 - **Username:** Enter the username required to authenticate device communications.
 - **Password:** Enter the password required to authenticate device communications.
7. Select **OK**.

The device status reports as "Connected" at the bottom of the selected tool if communications have been established.

Text Console - Connection Status

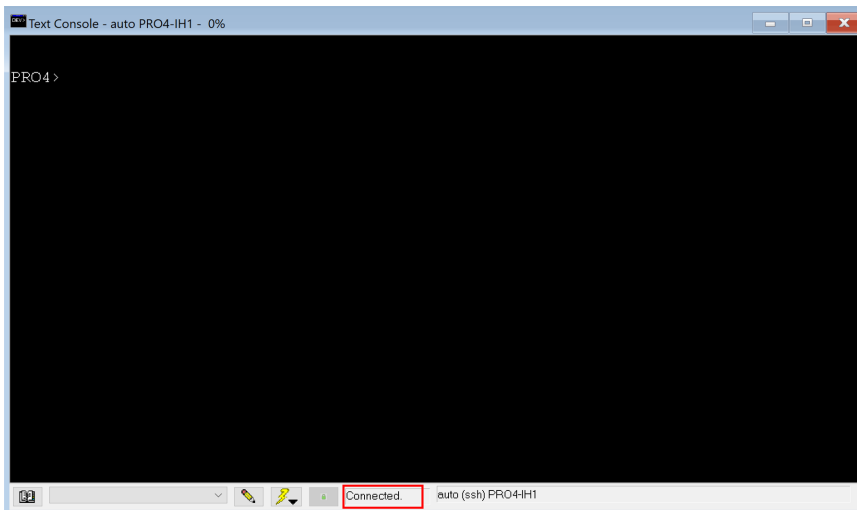

The USB connection information for the control system may be saved using the **Address Book** function in Crestron Toolbox. For more information, refer to the [Crestron Toolbox help file](#).

TCP/IP Connection

DHCP (dynamic host configuration protocol) is enabled by default for 4-Series control systems.

NOTE: Crestron Toolbox autodiscovery can be used if the control system has access to the DHCP server. The **Device Discovery** tool may also be used to discover the device and its IP address on the network.

If DHCP is available on the local network, no additional configuration changes are required. If DHCP is not available or if the administrator wishes to configure a static IP, the IP address, default gateway, and DNS server settings must be set.

NOTE: If DHCP is off, it can be turned on from the control system front panel by pressing the **HW-R** button. Once the **HW-R** LED begins to flash, press the **SW-R** button three times rapidly.

Static IP settings may be configured via USB using the **Text Console** tool or the **Ethernet Addressing** function in Crestron Toolbox.

To configure Ethernet settings using the **Text Console** tool:

1. Connect the **LAN** port of the control system to the LAN with an Ethernet cable.
2. Open Crestron Toolbox software.
3. Select the **Text Console** tool (**Tools > Text Console**).
4. Establish a USB connection to the control system as described in [USB Connection on page 205](#).
5. Issue the following commands:
 - `dhcp 0 off` - Turns off DHCP to use manually configured network information
 - `ipaddress 0 xxx.xxx.xxx.xxx` - Sets the IP address of the control system to the specific address, where "xxx.xxx.xxx.xxx" is the four octets of the IP address
 - `ipmask 0 xxx.xxx.xxx.xxx` - Sets the IP mask of the control system to the specified mask, where "xxx.xxx.xxx.xxx" is the four octets of the mask address
 - `defrouter 0 xxx.xxx.xxx.xxx` - Sets the default network gateway to the specified IP address, where "xxx.xxx.xxx.xxx" is the four octets of the default router address
 - `adddns xxx.xxx.xxx.xxx` - Sets the DNS (domain name server) to use for DNS name lookups, where "xxx.xxx.xxx.xxx" is the four octets of the DNS address.

NOTES:

- Although the control system will prompt that a reboot is required, the commands above can be performed prior to executing the reboot.
- The commands above are used to configure static IPv4 Ethernet addressing on the control system. The control system also provides commands to configure static IPv6 Ethernet addressing. Issue the `help ipv6*` command to return all commands related to IPv6 configuration.

To configure Ethernet settings using the **Ethernet Addressing** function, refer to the [Crestron Toolbox help file](#).

Once a static or dynamic IP address has been set for the control system, the TCP/IP connection information for the control system may be saved using the **Address Book** function in Crestron Toolbox. For more information, refer to the [Crestron Toolbox help file](#).

Set a Logon Banner

A logon banner can be loaded to the control system that is shown when a user connects to the control system successfully over SSH or web server. A sample logon banner is shown below.

Sample Logon Banner

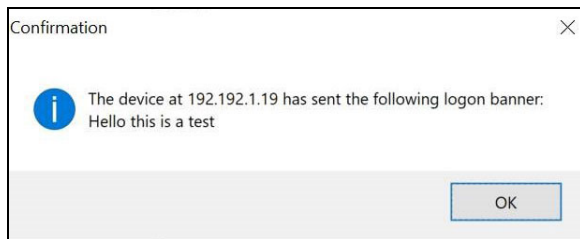

To load a logon banner to the control system:

1. Create the banner text file using a text editing application. The text file must be a regular ASCII file (not using UTF-16 or any other encoding).
2. Save the text file as **banner.txt**.
3. Use an SFTP client to load the **banner.txt** file to the `\sshbanner` directory on the control system.

Time and Date Settings

The internal clock of the control system can be configured using console commands.

1. Issue the `timedate` command to manually set the time and date.
 - **Syntax:** `timedate [hh:mm:ss mm-dd-yyyy]`
 - For `hh:mm:ss`, enter the time in hours (using 24-hour format), minutes, and seconds format.
 - For `mm-dd-yyyy` (or `mm/dd/yyyy`), enter the date in month (1–12), day (1–31), and year format.
 - **Example:** `timedate 12:18:30 03-14-2021`
2. Issue the `timezone` command to set the time zone:
 - **Syntax:** `timezone [list | zone]`
 - For `zone`, enter the three-digit code for the time zone.
 - Use the `list` parameter to print a list of all time zones and their codes in the console.
 - **Example:** `timezone 014`
3. Issue the `sntp start` command to synchronize the internal clock with an SNTP server:
 - **Syntax:** `sntp start [server:address]`
 - For `server:`, enter the address (in dot decimal notation) of the SNTP server.
 - **Example:** `sntp start server:255.255.255.255`

The internal clock can also be set using the **System Clock** function in Crestron Toolbox. For more information, refer to the [Crestron Toolbox help file](#).

Authentication

4-Series control systems provide various authentication options that can be used to create user accounts and passwords, to set password policies, and to set access levels for users and groups.

NOTE: Authentication is turned on by default for shipping control systems and cannot be turned off. However, authentication can be turned off for control systems in existing installations, even following an upgrade (with the exception of -R series residential control systems, which force authentication on following a firmware upgrade).

Use the following procedures to configure authentication settings on the control system.

Create an Admin Account

The first time the web configuration interface is accessed, a dialog box is displayed asking the user to create an admin account. A similar message is displayed when connecting to the control system in Crestron Toolbox software if an admin account has not already been created.

To create an admin account:

1. Enter a username and password for the admin account in the appropriate text fields.

CAUTION: Do not lose the username and password for the admin account, as the control system must be reset to factory settings to regain access.

2. Select **OK**. The username and password created in step 1 must be entered to regain access to the web configuration interface.

NOTE: The username and password must also be entered when connecting from Crestron Toolbox.

Account Recovery

If the username or password for the admin account is lost, the following procedures can be used to recover access.

Factory Restore

To perform a factory restore, follow the procedure described in [Restore to Factory Defaults on page 263](#). All control system settings are restored to their factory defaults, and all user and group accounts are removed.

Upon connecting to the control system after it has been restored, the control system will prompt to create an admin account as described in [Create an Admin Account on page 210](#).

Password Recovery Command

The `pwdrecovermode` command can be issued to configure a password recovery mode on the control system. The password recovery mode is turned off by default and must be turned on by the user.

NOTE: The password recovery mode must be turned on prior to attempting to recover a password.

- **Syntax:** `pwdrecovermode [on | off]`
 - `on` - Turns on password recovery mode for the control system
 - `off` - Turns off password recovery mode for the control system
- **Example:** `pwdrecovermode on`

If password recovery mode is turned on, press and hold the **SW-R** button on the control system for 15 seconds to bypass authentication, which allows the user to log in to the control system without entering a password. The user will be prompted to create a new account following the next restart.

User and Group Management

Local users and groups can be added to the control system after an administrator account has been created. Additionally, the control system can grant access levels to existing Active Directory users and groups.

The following sections describe how to manage users and groups on the control system.

NOTE: Additional console commands for listing users and groups and for showing user information can be viewed by issuing the `help system` command.

Add Local User

To add a local user to the control system, issue the `adduser` command.

- **Syntax:** `adduser -n:username -p:password`
 - `-n:` - Specifies the name of the local user that will be created
 - `-p:` - Specifies a password for the local user
- **Example:** `adduser -n:jsmith -p:user01`

A local user is created without any access rights. To assign access rights to a local user, the user must be added to at least one local group. For more information, refer to [Add User to Group on page 214](#).

Delete Local User

To remove a local user from the control system, issue the `deleteuser username` command.

When a local user is removed, the user is also removed from any local groups.

Add Local Group

To add a local group to the control system, issue the `addgroup` command.

- **Syntax:** `addgroup -n:groupname -l:accesslevel`
 - `-n:` - Specifies the name of the local group that will be created
 - `-l:` - Specifies the access level for the local group
 - `a` - Administrator
 - `p` - Programmer
 - `o` - Operator
 - `u` - User
 - `c` - Connection only
- **Example:** `addgroup -n:CresProgs -l:p`

NOTE: A predefined access level must be assigned to a group when it is created.

When a user is added to a group, the user inherits the access level set for the group. Certain control system functions and console commands are accessible only to users with corresponding access levels.

If a user belongs to multiple groups, the user's access level is the combined access level of all groups that contain the user.

Delete Local Group

To remove a local group from the control system, issue the `deletegroup groupname` command.

When a local user group is removed, users in the group are not removed from the control system. However, the user will lose the access rights associated with the removed group.

Add Active Directory Group

To add an existing Active Directory group to the control system, issue the `adddomaingroup` command.

NOTE: Use the `adlogin` command to log in to the Active Directory server.

- **Syntax:** `adddomaingroup -n:groupname -l:accesslevel`
 - `-n:` - Specifies the name of the Active Directory group to be added
 - `-l:` - Specifies the access level for the Active Directory group
 - `a` - Administrator
 - `p` - Programmer
 - `o` - Operator
 - `u` - User
 - `c` - Connection only
- **Example:** `adddomaingroup -n:ADProgs -l:p`

NOTE: The control system cannot create or remove a group from the Active Directory service, but it can grant an access level to an existing Active Directory group.

All users of the Active Directory group inherit the access level set for the group. Certain control system functions and console commands are accessible only to users with corresponding access levels.

Remove Active Directory Group

To remove a local group from the control system, issue the `deletedomaingroup groupname` command.

When an Active Directory group is removed from the control system, it is not deleted from the Active Directory service. Once the group is removed from the control system, all members of that group lose access to the control system.

Add User to Group

To add a local or an Active Directory user to a local group, issue the `addusertogroup` command.

- **Syntax:** `addusertogroup -n:username -g:groupname`
 - `-n:` - Specifies the name of the local or Active Directory user
 - `-g:` - Specifies the name of the local group
- **Example:** `addusertogroup -n:jsmith1 -g:CresProgs`

Local users are created on the control system without any access rights. Adding a user to a local group grants the user the access level assigned to the group.

NOTE: The control system cannot create or remove a user from the Active Directory service, but it can grant an access level to an existing Active Directory user. This may be accomplished either by adding the Active Directory user to a local group on the control system or by adding the Active Directory group(s) of which the user is a member to the control system.

Remove User from Group

To remove a local or an Active Directory user from a local group, issue the `removeuserfromgroup` command.

- **Syntax:** `removeuserfromgroup -n:username -g:groupname`
 - `-n:` - Specifies the name of the local or Active Directory user
 - `-g:` - Specifies the name of the local group
- **Example:** `removeuserfromgroup -n:jsmith1 -g:CresProgs`

User Group Rights

The control system has built-in access levels representing various roles that can be assigned to a group. These access levels apply to all users within that group. Each access level is associated with a set of specific permissions:

1. Access system information and status (read-only).
2. Connect to the device Web XPanel interface.
3. Authenticate CIP and gateway connections.
4. Receive complete administrator access, including managing user accounts and all system settings.
5. Issue programmer commands for user programs, such as loading programs and related files.
6. Issue operator commands for user programs, such as restarting programs

The following table indicates the permissions that are given to each of the available access levels. The numbers in the table header row correlate with the numbered list items above.

Default Rights of Local Groups

	1	2	3	4	5	6
Administrator	Yes	Yes	Yes	Yes	Yes	Yes
Programmer	Yes	Yes	Yes	No	Yes	Yes
Operator	Yes	Yes	Yes	No	No	Yes
User	No	Yes	No	No	No	No
Connection Only	No	Yes	Yes	No	No	No

By default, the control system has five groups available (one for each access level): Administrator, Programmer, Operator, User, and Connection Only. The initial user is added to the Administrator group. The default groups may be used, or custom groups can be created with the appropriate access level permissions as needed.

Password Management

The following sections explain how to manage passwords for local users on the control system.

Set Password Policy

To set the password policy for the control system, issue the `setpasswordrule` command.

- **Syntax:** `setpasswordrule {-all | -none} | { -length:minpasswordlength} {-mixed} {-digit} {-special}`
 - `-all` - All password rules are applied.
 - `-none` - No password rules are applied.
 - `-length:` - Specifies the minimum password length. By default, the minimum password length is six characters.
 - `-mixed` - Specifies that the password must contain a lower and upper case character.
 - `-digit` - Specifies that the password must contain a number character.
 - `-special` - Specifies that the password must contain a special character.

NOTE: The `-length`, `-mixed`, `-digit`, and `-special` parameters cannot be combined with `-none`.

- **Example:** `setpasswordrule -length:9 -mixed -digit -special`

NOTE: The following special characters are permitted: ` ~ ! @ \$ % ^ & * () _ + = { } [] | ; " < > , .

All passwords that are created, updated, or reset for local users must follow the password rules set by this command to be considered valid.

Update Local Password

To update the current user's password, issue the `updatepassword` command.

Users may update their password. The user is prompted to enter the current password once and the new password twice. If the old password does not match the current password, the operation fails and the password is not changed.

Reset User Password

To reset a user's password, issue the `resetpassword` command.

- **Syntax:** `resetpassword -n:username -p:defaultpassword`
 - `-n:` - Specifies the user whose password will be reset
 - `-p:` - Specifies a default password that can be provided to the user following the reset
- **Example:** `resetpassword -n:jsmith1 -p:Default321!`

Login Behavior

Users must enter a username and password to connect to the control system.

A user is given a maximum of three login attempts for each type of transport protocol (Ethernet and USB). If a user fails to authenticate against console within the maximum attempts allowed, the transport protocol used to attempt the connection is blocked.

- For USB transport, the transport is blocked for 5 minutes after the maximum logon attempt is reached. If the user tries again after 5 minutes and continues to fail, the block time is doubled. The block time continues to be doubled until a successful logon or control system restart happens. Once a user successfully authenticates against console, the failure count is reset to zero, and the block time is reset to 5 minutes.
- For Ethernet transport, after a remote IP fails to logon within maximum attempts allowed, the console forces the transport to close and blocks further logon attempts from that remote IP for 24 hours.

NOTE: To regain access to the control system from a blocked IP, successfully log in to the console over USB or from a different IP address, and then use the `remblockedip` console command to remove the blocked IP. For more information, refer to [Blocked IP Address Functions on page 219](#).

Local User Login

If a user opens a connection to the console, the console prompts the user for a username and password as shown in the example below.

```
PR04 Console
Login: jsmith1
Password: *****
PR04>
```

Local users are created with no access rights. Even if a user has an account in the control system, the user cannot connect to the control system console unless the user been added to a group. To grant access to the user, an administrator must ensure that the user has been first added to a group.

Active Directory Login

To log onto the console as an Active Directory user, both the domain name and username must be provided (separated by a "\" or "/") when prompted by the console.

```
PR04 Console
Login: csusers\jsmith1
Password: *****
PR04>
```

After an administrator adds an Active Directory user or group to the control system, the name and SID of the user or group is stored in the control system.

When an Active Directory user attempts to authenticate against the console, the console in turn uses the user credentials to authenticate against the Active Directory service. If the Active Directory authentication is successful, the console queries the Active Directory service for the user's SID:

- If the user has been added to the control system, the console compares the SID from the Active Directory service with the stored SID. Access is granted to the user only if the SIDs match.
- If the user has not been added to the control system, the console queries the Active Directory service for all groups containing the user and retrieves the group SIDs. The console then iterates these SIDs to compare them to the stored group SIDs. Access is granted to the user only if at least one match is found.

Session Timeout Functions

By default, a user is never logged off automatically unless the value for the logon session timeout is manually changed.

If the value for logon session timeout has been changed, the console starts a timer after a user logs in and monitors the user's activities. If a user is idle for more than a set duration, the console logs the user out automatically.

Change Session Timeout Duration

To change the duration for the logon session timeout, issue the `setlogoffidletime` command.

- **Syntax:** `setlogoffidletime [minutes]`
 - `minutes` - The duration (in minutes) that must elapse before the console logs off an idle user. Entering 0 prevents the user from being logged off automatically. The default value is "20."
 - No parameter - Displays the current timeout setting
- **Example:** `setlogoffidletime 30`

Change Login Failure Count

To change the value for the logon failure count, issue the `setloginattempts` command.

- **Syntax:** `setloginattempts [number]`
 - `number` - The number of login attempts allowed before the console is blocked. Entering 0 allows unlimited attempts. The default value is "3."
 - No parameter - Displays the current setting
- **Example:** `setloginattempts 3`

Locked User Functions

Administrators can lock user accounts, which prevents access to the control system via the console and Crestron Toolbox.

Add User to Locked List

To add a user to the locked list, issue the `addlockeduser` command.

- **Syntax:** `addlockeduser [name]`
 - `name` - Enter the user account that will be locked.
 - No parameter - Lists all locked user accounts
- **Example:** `addlockeduser jsmith1`

Remove User from Locked List

To remove a users from the locked list, issue the `remlockeduser` command.

- **Syntax:** `remlockeduser [name]`
 - `name` - Enter the user account that will be removed from the locked list
 - No parameter - Lists all locked user accounts
- **Example:** `remlockeduser jsmith1`

Blocked IP Address Functions

When a user reaches the maximum number of login attempts over an Ethernet connection, the client's IP address is blocked.

Change Lock out Time

To change the duration (in hours) that an IP address is blocked by the console, issue the `setlockouttime` command.

- **Syntax:** `setlockouttime [number]`
 - `number` - The number of hours to block an IP address. Entering 0 blocks the IP address indefinitely. 255 is the maximum value. The default value is "24."
 - No parameter - Displays the current setting
- **Example:** `setlockouttime 24`

Add IP Address to Blocked List

To add an IP address to the blocked list manually, issue the `addblockedip` command.

- **Syntax:** `addblockedip [ipaddress]`
 - `ipaddress` - Enter the IP address that will be blocked.
 - No parameter - Lists all blocked IP addresses
- **Example:** `addblockedip 255.255.255.255`

Remove IP Address from Blocked List

To remove an IP address from the blocked list manually, issue the `remblockedip` command.

- **Syntax:** `remblockedip [ipaddress]`
 - `ipaddress` - Enter the IP address that will be removed from the blocked list.
 - No parameter - Lists all blocked IP addresses
- **Example:** `remblockedip 255.255.255.255`

Certificate Management

Security certificates for 802.1X and other security protocols can be added, removed, and managed from the console.

The control system supports five types of certificates:

- **Root:** The Root certificate is used by the control system to validate the network's authentication server. 4-Series control systems have a variety of Root certificates, self-signed by trusted CAs (Certificate Authorities), that are preloaded into the device. Root certificates must be self-signed.
- **Intermediate:** The Intermediate store holds non self-signed certificates that are used to validate the authentication server. These certificates are provided by the network administrator if the network does not use self-signed Root certificates.
- **User:** The User store holds additional certificates not used in the 802.1X standard.
- **Machine:** The Machine certificate is an encrypted PFX file that is used by the authentication server to validate the identity of the control system. The machine certificate will be provided by the network administrator, along with the certificate password.
- **WebServer:** A WebServer certificate is an encrypted PFX file that is used by the web server. This certificate will be provided by the network administrator along with the certificate password. This certificate is presented to any clients that connect to the web server.
- **WebSocket:** A WebSocket certificate is used to validate the network's authentication server via the WebSocket (WSS) protocol. This certificate is an encrypted PFX file.

NOTES:

- No more than one of each of the following certificate type may be stored on the control system: Machine, WebServer, and WebSocket.
- 3DES and lower encryption algorithms are not supported for PKCS12 format certificates.

Certain certificates can also be managed using the **Security Certificates** function in Crestron Toolbox. For more information, refer to the [Crestron Toolbox help file](#).

Certificate Requirements

4-Series control systems support all standard X.509v3 certificates that use the following:

- RSA key with length 2048, 3072, or 4096 bits
- ECC keys with lengths based on standard curves
- Hash algorithms using SHA-1, SHA-256, SHA-384, or SHA-512

Add a Certificate

The `certificate` command provides two options for adding certificates to the control system.

- The `certificate addf` option allows the certificate file name to be specified.
- The `certificate add` option expects a specific, fixed file name.

The following procedures describe how to add certificates to the control system using the above commands.

Add Root, Intermediate, or User Certificates

To add a Root, Intermediate, or User certificate to the control system using the `certificate addf` command:

1. Use an SFTP client to upload the certificate file (in `.cer` or `.pem` format) to the `\cert` directory.
2. Issue the `certificate addf <certificate name> <certificate store>` command.
 - `certificate name` - The name of the certificate file
 - `certificate store` - The certificate store where the certificate file will reside
[`root|user|intermediate`]

To add a Root, Intermediate, or User certificate to the control system using the `certificate add` command (requires the uploaded certificate file to have a specific name):

1. Use an SFTP client to upload the certificate file (in `.cer` or `.pem` format) to the `\cert` directory. The file must be named based on the certificate type as described in step 2.
2. Issue the `certificate add <certificate store>` command.
 - `certificate_store` - The certificate store where the certificate file will reside:
 - `root` - The certificate file must be named "root_cert.cer".
 - `user` - The certificate file must be named "user_cert.cer".
 - `intermediate` - The certificate file must be named "intermediate_cert.cer".

Add Machine, WebServer, or WebSocket Certificates

Machine, WebSocket, and WebServer certificate types must be accompanied by their private keys. These types of certificates consist of a single encrypted PFX file which contains both the certificate and the key. When adding these certificate types to the control system, the encryption password must be supplied.

To add a Machine, WebServer, or WebSocket certificate to the control system using the `certificate addf` command:

1. Use an SFTP client to upload the certificate PFX file to the `\cert` directory.
2. Issue the `certificate addf <certificate name> <certificate store> <password>` command.
 - `certificate name` - The name of the certificate file
 - `certificate store` - The certificate store where the certificate file will reside
[`machine|webserver|websocket`]
 - `password`: The password used to encrypt the PFX file

To add a Machine, WebServer, or WebSocket certificate to the control system using the `certificate add` command (requires the uploaded certificate file to have a specific name):

1. Use an SFTP client to upload the certificate PFX file to the `\cert` directory. The file must be named based on the certificate type as described in step 2.
2. Issue the `certificate add <certificate store> <password>` command.
 - `certificate store` - The certificate store where the certificate file will reside:
 - `machine` - The certificate file must be named "machine_cert.pfx".
 - `webserver` - The certificate file must be named "webserver_cert.pfx".
 - `websocket` - The certificate file must be named "websocket_cert.pfx".

List and View Certificates

Certificates installed in a control system store can be listed using the `certificate list` or `certificate listn` commands.

NOTE: The `certificate listn` command adds line numbers to the output.

- **Syntax:** `certificate [list | listn] <certificate_store>`
 - `certificate store` - The store where the certificate is installed
[`root|user|intermediate|machine|webserver|websocket`]
- **Example:** `certificate list intermediate`

To view additional details about a certificate, issue the `certificate view` command.

- **Syntax:** `certificate view <certificate store> [<certificate number>|<certificate name> <certificate UID>]`
 - `certificate store` - The store where the certificate is installed [`root|user|intermediate|machine|webserver|websocket`]
 - `certificate number` - The certificate number as exposed by the `certificate listn` command
 - `certificate name` - The certificate name as exposed by the `certificate list` commands (the name is case-sensitive and may contain spaces)
 - `certificate UID` - The certificate UID as exposed by the `certificate list` commands
- **Example:** `certificate view intermediate my_cert.cer 0.9.2302.00200300.100.1.3`

Remove a Certificate

To remove a certificate from the control system, issue the `certificate rem` command.

- **Syntax:** `certificate rem <certificate store> [<certificate number>|<certificate name> <certificate UID>]`
 - `certificate store` - The store where the certificate is installed [`root|user|intermediate|machine|webserver|websocket`]
 - `certificate number` - The certificate number as exposed by the `certificate listn` command
 - `certificate name` - The certificate name as exposed by the `certificate list` commands (the name is case-sensitive and may contain spaces)
 - `certificate UID` - The certificate UID as exposed by the `certificate list` commands
- **Example:** `certificate rem intermediate my_cert.cer 0.9.2302.00200300.100.1.3`

TLS

4-Series control systems provide support for Transport Layer Security (TLS). TLS is a protocol that provides a secure channel for communication between two machines. The secure channel is transparent and passes data through unchanged. The data is encrypted between the client and the server, but the data the one end writes is exactly what the other end reads.

Previous control system software releases supported several SSL (Secure Sockets Layer) and TLS protocols, but have since been updated to allow only TLS version 1.2.

To configure TLS settings, issue the `ssl` command:

NOTE: Newer 4-Series control systems do not allow TLS to be turned off. The “off” option is allowed only for older 4-Series control systems in existing installations (with the exception of -R series residential control systems, which force TLS on following a firmware upgrade).

- **Syntax:** `ssl [off | self | ca [-p:privatekeypassword]]`
 - `off`: - Turns off TLS if it is on (not valid for newer control systems)
 - `self` - Turns on TLS using a self-signed certificate
 - `ca`: Turns on TLS using a CA-signed certificate. The `-p` argument may be provided with the private key password for the CA-signed certificate. If the key is encrypted and the password is not provided, the control system will prompt for the password.
 - No parameter: Displays the current setting
- **Example:** `ssl ca -p:myprivatekeypassword`

NOTE: When TLS is turned on, the control system uses a server certificate. For more information, refer to [Server Certificates on page 225](#).

TLS certificates may also be managed using the **SSL Management** function in Crestron Toolbox. For more information, refer to the [Crestron Toolbox help file](#).

Server Certificates

When TLS is turned on, the control system uses a server-side certificate to authenticate various control system components, including the web server.

One of the following three server-side certificate types are used:

- A self-signed certificate that is generated by the control system
- A CA (Certificate Authority)-signed certificate that is loaded onto the control system
- An externally requested and signed certificate and private key that are loaded onto the control system

Instructions for configuring each server certificate type are provided in the sections that follow.

Self-Signed Certificates

A self-signed certificate is generated by the control system automatically as needed. It is always available and will be used by default when a certificate is needed but no other certificate is available. It is also used when the `ssl self` command is issued.

CA-Signed Certificates

A CA-signed certificate starts with a certificate request. The request can be generated by the control system, or it can be generated via an external process. When installing the signed certificate, the only difference is that the external process also produces a private key that is installed along with the certificate.

The following procedures are used to obtain and load a CA-signed certificate to the control system.

Generate a Certificate Signing Request (CSR)

To generate a certificate signing request, issue the `createcsr c:st:l:o:ou:cn:e [-i:option]` command, where the following parameters are replaced with the appropriate data that should appear in the certificate:

NOTE: Any parameter that is not required can be left blank as needed.

- `c` - The two letter country code (corresponding to ISO 3166)
- `st` - State or province name
- `l` - Locality or city name
- `o` - Organization name (required)
- `ou` - Organizational or unit name
- `cn` - Common name (required)

NOTE: The common name is not transferable, and thus must be one that is used by clients.

- `e` - Email address
- `-i` - Ignores blank parameters in the CSR request. Valid values are `true` and `false`.

Example: `createcsr us:nj:rockleigh:"Crestron Electronics"::device.crestron.com:-i:true -s:dns:altname.crestron.com,ip:192.168.0.1`

Be aware that generating a CSR will overwrite any previous CSR and private key, rendering that previous CSR useless. It will not affect any certificate and private key in use that may have been loaded.

Only the `ou` and `e` fields may be left blank and not included in the CSR by specifying the `-i:true` option. Other fields are not affected by the `-i` option and will always be included in the CSR. If the `-i:true` option is not specified, the `ou` and `e` fields will also always be included in the CSR, even if left blank. Fields that are left blank, but still in the CSR, will be set to default values. Because these default values are not likely to be accurate for most environments, it is recommended to always fill in all fields except `ou` and `e`, use the `-i:true` option, and fill in `ou` and `e` if needed.

By default, a certificate request for a certificate with a 2048-bit RSA signature is requested. The CSR "request.csr" file is saved automatically to the internal `\sys` directory of the control system.

Obtain the Certificate

The exact procedures required to obtain a CA-signed certificate differ depending on the CA, but in all cases, it is necessary to submit the request.csr file along with any other verification that the CA requires.

To obtain the request.csr file:

1. Using SSH, issue the `move \sys\request.csr \user` command.
2. Use an SFTP client to copy the request.csr file from `\user` directory of the control system.

In some cases, it may be necessary to open the .csr file in a text editing program and to copy and paste the text between the "Begin certificate request" and "End certificate request" delimiters before sending the file to the CA.

NOTE: All certificate files must be in .pem format.

Load the Certificate Files

Once the CA validates the request.csr file, the CA issues the validated certificate to the requester. The following certificate files are required for deployment on the control system:

- CA-signed certificate in .pem format
- Certificates for each CA in the signing chain, with one certificate per file

NOTE: If the CA sends all signing certificates in a single file, it will be necessary to use an editor to extract and store each certificate individually. Each certificate in such a PEM bundle is delimited by "BEGIN CERTIFICATE" and "END CERTIFICATE" headers. These headers must be included in each CA certificate file, along with the PEM data between them.

To upload the CA-signed certificate to the control system:

1. If there are multiple certificates in the signing chain, install each non-root certificate in the intermediate store as described in [Add a Certificate on page 222](#).
2. Rename the remaining two certificate files (the root CA certificate and the signed certificate file) as follows:
 - Rename the signed certificate file to "srv_cert.cer".
 - Rename the root certificate file to "rootCA_cert.cer".
3. Use an SFTP client to copy the two certificate files to the `\user` directory on the control system.
4. Connect to the control system via SSH or Crestron Toolbox.
5. Issue the `delete \sys\rootCA_cert.cer` and `delete \sys\srv_cert.cer`, commands to delete any existing certificate files.
6. Issue the `move \user\rootCA_cert.cer \sys` and `move \user\srv_cert.cer \Sys` commands to move the new certificate files to the internal `\sys` directory.

Turn on TLS with the CA-Signed Certificate

To turn on TLS with the CA-signed certificate:

1. Issue the `ssl ca` command in the control system console.

NOTE: Neither a password nor a private key are required when the certificate originated from a `createcsr` command within the same device.

2. Issue the `reboot` command to restart the control system.

Externally-Generated Certificate Requests

The following procedures are used to load an a CA-signed certificate to the control system when the certificate request was not created with the `createcsr` command. In this case, the CA will provide a private key along with the signed certificate.

The following certificate files are required for deployment on the control system. These files are generally provided by the IT administrator:

- Private key in .pem format
- CA-signed certificate in .pem format
- Certificates for each CA in the signing chain, with one certificate per file

As a best practice, maintain certificates and keys in a secure location other than the control system. If the control system ever needs to be restored to defaults or replaced with a new unit, the installed certificate and key may be lost.

NOTE: If the CA sends all signing certificates in a single file, it will be necessary to use an editor to extract and store each certificate individually. Each certificate in such a PEM bundle is delimited by "BEGIN CERTIFICATE" and "END CERTIFICATE" headers. These headers must be included in each CA certificate file, along with the PEM data between them.

Load the Certificate Files

To upload the externally-signed certificate to the control system:

1. If there are multiple certificates in the signing chain, install each non-root certificate in the intermediate store as described in [Add a Certificate on page 222](#).
2. Rename the remaining three certificate files as follows:
 - Rename the private key file to "srv_key.pem".
 - Rename the signed certificate file to "srv_cert.cer".
 - Rename the root certificate file to "rootCA_cert.cer".
3. Use an SFTP client to copy the three certificate files to the `\user` directory on the control system.
4. Connect to the control system via SSH or Crestron Toolbox.
5. Issue the `delete \sys\rootCA_cert.cer`, `delete \sys\srv_cert.cer`, and `delete \sys\srv_key.pem` commands to delete any existing certificate files.

6. Issue the `move \user\rootCA_cert.cer \sys,move \user\srv_cert.cer \sys, and move \user\srv_key.pem \sys` commands to move the new certificate files to the internal `\sys` directory.

Turn on TLS with the CA-Signed Certificate

To turn on TLS with the CA-signed certificate:

1. Issue the `ssl ca -p: <privatekeypassword>` command in the control system console.

NOTE: The password is required if the private key in `srv_key.pem` is encrypted. If a password is needed but not provided with the `ssl` command, the control system will prompt for the password.

2. Issue the `reboot` command to restart the control system.

802.1X

802.1X is an IEEE network standard designed to enhance the security of wireless and Ethernet LANs. It is widely used in corporate networks to provide an authentication mechanism for devices wishing to connect to the network. The standard relies on the exchange of messages between the device and the network's host, or authentication server.

To enable and configure 802.1X for the control system:

1. Issue the `8021xauthenticate` on command to enable 802.1X.
2. Issue the `8021xvalidateserver` on command to allow the control system to verify the identity of the network's authentication server. Issuing this command allows certificates signed by trusted CAs (Certificate Authorities) to be selected, which is used during server validation.

NOTE: Using the `8021xvalidateserver` command is optional based on the recommendation of the network administrator, but the option should be enabled for most applications.

3. Issue the `8021xmethod [password | certificate]` command to select the secure password method or the certificate method depending on the network administrator's requirement.
4. If the certificate method was selected, issue the `certificate add machine {certificate_name} {password}` command to add the machine certificate supplied by the network administrator to the certificate store. Refer to [Add a Certificate on page 222](#).

NOTE: The machine certificate is an encrypted PFX file that will be supplied by the network administrator, along with the certificate password. The machine certificate is used to verify the identity of the control system.

5. If the password method was selected, enter the username and password supplied by the network administrator:
 - a. Issue the `8021xusername [username]` command to enter the username supplied by the network administrator.
 - b. Issue the `8021xpassword [password]` command to enter the password supplied by the network administrator.

NOTE: A machine certificate is not required for the password method.

6. If the validate server option is enabled, select the certificates that will be used for server validation:
 - a. Issue the `8021xtrustedcas list` command to list all trusted certificates stored on the control system.
 - b. Issue the `8021xtrustedcas use {certificate_name}` command to enable a certificate for validation. Multiple certificates may be enabled.

NOTE: If the network does not use any of the listed certificates, the network administrator will provide a certificate that must be uploaded to the control system manually using the `certificate add [certificate_store] {certificate_name}` command. If the certificate is self-signed, enter `root` for `certificate_store`. If the certificate is not self-signed, enter `intermediate` for `certificate_store`.

7. If required, issue the `8021xdomain [domain_name]` command to set the domain name of the network.
8. Issue the `reboot` command to restart the control system with the new 802.1X settings.

802.1X configuration can also be performed using the **802.1X** function in Crestron Toolbox. For more information, refer to the Crestron Toolbox help file.

Firmware Updates

To take advantage of all the latest device features, the control system should always run the latest firmware PUF (Package Update File), which is available for download at the appropriate device product page or www.crestron.com/Support/Resource-Library.

NOTE: Access to firmware is reserved for Authorized Crestron dealers, Crestron Service Providers (CSPs), and Crestron partners only. New users must register for an account to access certain areas of the Crestron website. For more information on registering, navigate to www.crestron.com/register.

To perform a firmware update:

1. Download the latest device firmware as described above.
2. Use an SFTP client to transfer the firmware PUF to the control system's **/firmware** directory.
3. Issue the `puf <filename>` command in the control system console, where `<filename>` is the complete filename of the PUF, including the filename extension (.puf).

NOTE: Firmware updates can be scheduled using the control system's auto update mechanism. For more information, refer to [Auto Update Mechanism on page 251](#).

The **Package Update Tool** in Crestron Toolbox can also be used to send firmware to the control system and to manage the firmware update. For more information, refer to the [Crestron Toolbox help file](#). The web user interface for the control system can also be used to load firmware.

Message Logging

4-Series control systems provide messages when the control system performs a task or when it encounters an issue, such as a hardware or software failure, hardware incompatibility with software definitions, or a programming error.

NOTE: A **MSG** LED on the control system or controlled device may light to indicate that a logged event has occurred.

Messages created by the control system are written to a persistent log that is stored in the internal flash memory. The persistent log can be saved to external storage on supported models and can be viewed through the console or through Crestron Toolbox.

Persistent Log

The persistent log (PLOG) is a log of messages defined by the control system. The current PLOG can be viewed in the control system console and is available following a device restart. The control system stores the contents of the current PLOG file at `\plog\CurrentBoot`. The log file is locked and cannot be opened for transfer.

To print the contents of the current PLOG in the console, issue the `err plogcurrent` command.

Observe the following about the PLOG:

- If a soft restart is performed, any pending messages are written to the latest log file and zipped into one file. On restart, the zipped file at `plog\CurrentBoot` is moved to `\plog\PreviousBoot`. During subsequent restarts, the zipped file from `\plog\PreviousBoot` is moved to `\plog\ZippedLogs` for storage.
- The control system logs errors as long as there are not over 250 messages per two-minute period for two consecutive two-minute logging periods:
 - For each error period, the console displays a `PersistentLog: Error state threshold met` message if error logging is suspended.
 - When logging is suspended, the log file displays a `PersistentLog: Consecutive error states detected; logging is suspended` message, and the user receives a `PersistentLog is suspended, please contact dealer` message in the console.
 - Message logging resumes when there has been less than 10 error messages logged for 10 consecutive two-minute logging periods. When logging resumes, all messages from the 10 previous logging periods are logged to the PLOG file. The log in the console also displays a `PersistentLog: Consecutive quiet states detected; logging is resumed` message.

The PLOG can also be viewed in Crestron Toolbox using the **Error Log** function. For more information, refer to the [Crestron Toolbox help file](#).

Message Levels

The following table defines the six levels of messages that can appear in the persistent log.

4-Series Control System Message Levels

Type	Description
OK	General information about an event that has occurred
Info	General information about an event that has occurred
Notice	An event has occurred that is noteworthy but that does not affect program operation
Warning	An event has occurred that could affect program operation, but the program still runs normally
Error	An event has occurred indicating the program is not running as expected
Fatal	An event has occurred that prevents the program from running

Message Format

Each error message has the following format: `Level: Message.`

- `Level:` - The message level
- `Message` - A description of the message

Some error messages have a suffix with additional information in parenthesis:

`Level: {Application} [App#] # [Date/Time] # Message`

Example: `Ok: TLDM # 2021-03-12 16:23:43 # Router got Connected`

When reporting an error message to a [Crestron True Blue support](#) representative, report the exact message as it appears in the error log. The `Application` field indicates the program that produced the error.

NOTE: The `App#` field is displayed when there are multiple instances of a single application (such as `SimplSharpPro.exe`) running and indicates the program slot (1–10) to which the program is associated.

Remote System Logging

Control system messages can be captured and stored on a remote server using the remote system logging function.

NOTE: The remote server host must have system log server with the applicable security certificates and sufficient disk space to store the active system log. The host should also be configured to archive older system logs and to off load them over time. If TLS is turned on, a TLS-supported server with the appropriate certificates is required.

To configure remote system logging, issue the `remotesyslog` command.

- **Syntax:** `remotesyslog [-s:] {-e:} {-a} [-i:address] [-p:port] {-t:protocol} {-v:on|off}`
 - `-s: [on|off]` - Turns remote system logging on or off
 - `-e: [level]` - Logs all messages at the provided error level and above. The default setting is "Notice."
 - `ok`
 - `info`
 - `notice`
 - `warning`
 - `error`
 - `fatal`
 - `-a` - Appends the contents of the audit log to the system log
- NOTE:** Audit logging must be turned on to use this feature. For more information, refer to [Audit Logging on page 236](#).
- `-i:address` - Sets the remote server IP address for the system log in dot decimal notation or as an ASCII string containing the server host name (maximum 255 characters)
 - `-p:port` - The remote server port number in decimal notation
 - `-t:protocol` - The protocol used to connect to the remote server
 - `tcp`
 - `udp`
 - `ssl`
 - `-v:` - If SSL is turned on, set to `on` to require server verification or set to `off` to not require server verification.
 - No parameter: Displays the current setting
- **Example:** `remotesyslog -s:on -e:notice -a -i:255.255.255.255 -p:12345 -t:ssl -v:off`

Remote system logging can also be configured in Crestron Toolbox using the **Syslog** function. For more information, refer to the [Crestron Toolbox help file](#).

Audit Logging

Audit logging can be turned on to track logons, logoffs, account management changes, and console commands.

NOTE: Logons, logoffs, and authentication management is always logged by the control system regardless of audit log settings.

Configure Audit Logging

To configure audit logging on the control system, issue the `auditlogging` command. Audit logging is turned off by default.

- **Syntax:** `auditlogging [on|off] {[all]|[none]}{admin} [prog] [oper] [user]} [remotesyslog]}`

- `on` - Turns on audit logging
- `off` - Turns off audit logging
- No parameter: Displays the current audit logging setting

The following access level parameters are optional and are used to log commands by access level:

- `admin` - Logs administrator-level commands
 - `prog` - Logs programmer-level commands
 - `oper` - Logs operator-level commands
 - `user` - Logs user-level commands
 - `all` - Logs all commands
 - `none` - Logs no commands
 - `remotesyslog` - Writes to the remote syslog server only
- **Example:** `auditlogging on admin oper`

Example log output: `[2021-11-30T07:02:44-08:00]: EVENT: COMMAND(SHELL 172.30.255.255) USER: admin # AUDITLogging on all`

View Audit Logs

To display the audit log in the console, issue the `getauditlog` command.

To print the last 50 audit log entries in the console, issue the `printauditlog` command. The optional `all` parameter can be appended to print the entire log.

NOTE: Use the **Audit Logs** function in Crestron Toolbox to change the audit log storage location and file name. For more information, refer to the [Crestron Toolbox help file](#).

Clear Audit Log

To clear all entries in the audit log, issue the `clearauditlog` command.

Control Subnet

Certain 4-Series control system models provide support for a separate network called a Control Subnet and have one or more network ports specifically for connecting devices to the Control Subnet.

The Crestron AV4, CP4N, and PRO4 have a dedicated Control Subnet, which allows for dedicated communication between the control system and Crestron Ethernet devices without interference from other network traffic on the LAN. The AV4 and PRO4 provide four Control Subnet ports that also support PoE+ using the optional [PW-5430DUS](#) power supply.

CAUTION: Do not connect the **CONTROL SUBNET** port to the LAN. The **CONTROL SUBNET** port must only be connected to Crestron Ethernet devices.

When using the Control Subnet, observe the following:

- The control system acts as a DHCP server to all devices connected to the Control Subnet and assigns IP addresses as needed.
- A DNS server is built in to the control system to resolve host names.
- Only connect Crestron Ethernet devices to the Control Subnet.
- The control system operates in isolation mode by issuing the `isolatenetworks on` command. When in isolation mode, the firewall is configured so that no communication can occur between the LAN and devices on the Control Subnet. Using this mechanism, customers can protect their corporate LAN from devices on the Control Subnet.
- When in isolation mode, devices on the Control Subnet do not have any resources on the LAN side. For example, if a touch screen with a SmartObjects® technology object requiring network access is installed on the Control Subnet, the object will not work.
- Devices on the LAN do not have access to any devices on the Control Subnet. Crestron Toolbox also does not have access to these devices when it is connected to the LAN. To configure devices on the Control Subnet with Crestron Toolbox (outside of runtime), the computer running Crestron Toolbox must be connected to the Control Subnet.
- Any NAT/port mapping rules that were previously created do not work when the control system is in isolation mode.

NOTE: If the control system is running in isolation mode, Crestron Ethernet devices requiring internet access should not be connected to the **CONTROL SUBNET** port (directly or indirectly) and should be instead connected to the LAN.

Control Subnet Architecture

Even if nothing is plugged into the **CONTROL SUBNET** port(s) on the back on the control system, the following are still present on the Control Subnet:

- Control System CPU (where AV programs run)
- Optional Expansion cards (PRO4 and AV4 only)

This design is in place to ensure that the Crestron CPU and optional expansion cards are protected from malicious packets on the LAN. Refer to the diagram below for more information on how these components work together.

Public LAN/Control Subnet Diagram

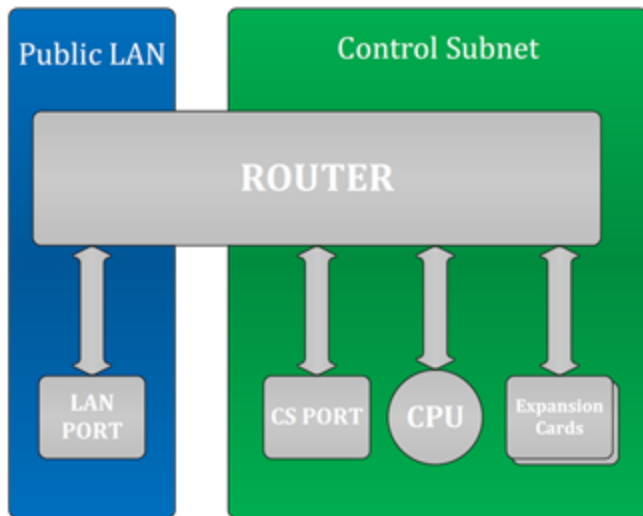

The firewall rules permit entry to only the traffic that is listened to by the CPU. As a result, a port scan will only show ports that are listened to by the CPU. Users can set up manual port forwarding rules to make custom connections to the devices on the Control Subnet. For more information, refer to [Port Forwarding on page 264](#).

Crestron Toolbox can create custom port forwarding rules in the 64000–64299 range to manage devices on the Control Subnet. These port forwarding rules are created when the tool connects and are broken down when the tool disconnects or when the device is rebooted.

Control Subnet Configuration

For increased security, the device supports a mode of operation called isolation mode. In isolation mode, the firewall is preconfigured to limit access to the Control Subnet, port mapping between the primary network and devices on the Control Subnet are blocked, and manual configuration of port forwarding is not available. To configure isolation mode, issue the following command:

```
isolatenetworks [state]
```

- state - {ON | OFF}
- No parameter - Displays the current setting

Example: `isolatenetworks on`

Control Subnet Router Configuration

By default, the Control Subnet router is configured to use 10.0.0.0/8 for the Control Subnet. If the device detects that the primary network is using that network address, the device will automatically switch to using 172.22.0.0/16 for the Control Subnet. To verify if the device is automatically choosing the Control Subnet address, issue the `CSINAutoMode` command. To confirm what address is being used, issue the `ipconfig` command to show the addresses assigned to the device's network interfaces.

If the control system will use a specific network address, that address can be configured using the following command:

```
CSRrouterPrefix [IP_Address/Prefix_Size]
```

- IP_Address - The desired IP address
- Prefix_Size - The number of leading bits of the routing prefix
- No parameter - Displays the current Control Subnet configuration

Example: `CSRrouterPrefix 192.168.0.0/24`

Control Subnet DHCP Configuration

By default, the device provides a DHCP server on the Control Subnet to issue IP addresses for anything connected to the Control Subnet. IP addresses that have been issued can be displayed by using the `DHCPLeases` command.

The `DHCPLeases` command will return a list of IP address that have been issued and information about them.

In addition, specific IP addresses can be assigned to specific devices on the Control Subnet. This can be done by issuing the following command:

```
RESERVEDleases [ADD | REM | CLEAR_ALL]
```

- ADD - Adds an IP address to a device using the following syntax: `MAC_Address IP_Address Description`

- MAC_Address - The device MAC address
- IP_Address - The device IP address
- Description - A description of the device
- REM - Removes a previously created IP address from the device using the following syntax: MAC_Address
 - MAC_Address - The device MAC address
- CLEAR_ALL - Clears all previous created IP addresses
- No parameter - Displays all current reserved DHCP leases in table format

Example: RESERVEDLeases ADD 81:51:CA:48:73:24 10.0.0.9 TestDevice

The MAC address should be in the format XX:XX:XX:XX:XX:XX on the command line.

Control Subnet Firewall Configuration

In isolation mode, the firewall is preconfigured to limit access to the Control Subnet and cannot be further configured. The firewall configuration in isolation Mode is as follows:

Control System Firewall Rules - Isolation Mode

Direction	Port(s)	Rule	Description
Inbound from LAN	22	To CPU	SSH
Inbound from LAN	80, 443	To CPU	Web server (if turned on)
Inbound from LAN	41794, 41796	To CPU	Crestron communication protocols
Inbound from LAN	Listen ports used by program	To CPU	Programmatic listeners
Inbound from LAN	49200	To CPU	Crestron HTML5 User Interface
Inbound from LAN	64000–64299	Blocked	In isolation mode, Crestron management tools cannot connect to any devices on the Control Subnet
Control Subnet Outbound to LAN	Any port	All other devices: Blocked	No outbound traffic is allowed
Inbound from LAN	User defined	Blocked	In isolation mode, no port forwarding can be managed by the user

Program Management

4-Series control systems are equipped with program slots that are used to store program files. Program files can be created using SIMPL and SIMPL# Pro, and allow the control system to be custom programmed to perform certain tasks or turn on certain system functionality.

Load Programs to the Control System

A program must be compiled and uploaded to the control system before it can be run by the control system.

- For more information on creating, compiling, and uploading a program using SIMPL and SIMPL# Pro, refer to the [appropriate help file](#).
- For more information on uploading a program using Crestron Toolbox, refer to the [Crestron Toolbox help file](#).

Program files can also be manually loaded to the control system by using an SFTP client to transfer the program file to the `/simpl/appXX` directory, where "XX" is the respective program slot on the control system.

IP Table Configuration

Programs running on the control system that use Ethernet to communicate between the control system and networked devices require an IP table. The IP table allows the control system to identify and communicate with Ethernet equipment on an IP network.

Each controlled Ethernet device has an IP table, which is also known as a master list. The master list specifies the IP ID of the controlled device and the IP address or fully-qualified domain name (FQDN) of the control system(s) that sends it commands.

The control system IP table lists the IP address/FQDN and the IP ID of every device in the network. The IP ID is a hexadecimal value that must be unique and ranges from 03 to FE.

NOTE: IP tables used in Ethernet-based Primary-Secondary applications have unique IP table requirements. For more information, refer to [Primary-Secondary Mode on page 247](#).

The following commands can be used to view, configure, create, and remove IP table entries for the control system.

NOTE: IP table information can also be entered using information given in SIMPL and SIMPL# Pro or via Crestron Toolbox. For more information, refer to the [appropriate help file](#).

View and Configure IP Table

To view and configure IP table settings for the control system, issue the `iptables` command.

- **Syntax:** `iptables [-p:program] [-t] [-i:id] [-c] [-o]`
 - `-p:program` - Enter `all` to display all programs or enter a number (0–10) to display the program for the respective program slot
 - `-t` - Displays IP table data in table format
 - `-i:id` - Enter the IP ID to display the entry for that ID.
 - `-c` - Clears the IP table for the specified program (requires `-p` parameter)
 - `-o` - Displays offline devices only
 - No parameters - Shows the IP Table for Program 1
- **Example:** `iptables -all -t`

Add Peer Entry

To add a peer (secondary) entry to the IP table, use the `addpeer` command.

- **Syntax:** `addpeer cpid ip_address/name [-d:device_id] [-c:ciport] [-p:program] [-u:roomid]`
 - `cpid` - The ID of the CIP node (in hexadecimal format)
 - `ip_address/name` - The IP address (in dot decimal notation) or the name of the site for DNS lookup
 - `-d:device_id` - The device ID in the device redirection table (in hex, must be less than 256)
 - `-c:ciport` - The CIP port number for the connection (must be greater than 256)
 - `-p:program` - The program number on the control system that uses the device (default is 1)
 - `-u:roomid` - The room ID used for communication with a Crestron Virtual Control server (max length is 32 characters, valid values are A–Z and 0–9)
- **Example:** `addpeer 13 255.255.255.255 -d:134 -c:458 -p:3 -u:avf469`

NOTE: For more information on connecting a device to Crestron Virtual Control, refer to the help file in the Crestron Virtual Control web configuration interface. To access the help file, select the question mark button  on the top left of the pag.

Remove Peer Entry

To remove a peer (secondary) entry from the IP table, use the `rempeer` command.

- **Syntax:** `rempeer ciped ip_address/name [-d:device_id] [-c:cipport] [-p:program] [-u:roomid]`
 - `ciped` - The ID of the CIP node (in hexadecimal format)
 - `ip_address/name` - The IP address (in dot decimal notation) or the name of the site for DNS lookup
 - `-d:device_id` - The device ID in the device redirection table (in hex, must be less than 256)
 - `-c:cipport` - The CIP port number for the connection (must be greater than 256)
 - `-p:program` - The program number on the control system that uses the device (default is 1)
 - `-u:roomid` - The room ID used for communication with a Crestron Virtual Control server (max length is 32 characters, valid values are A–Z and 0–9)
- **Example:** `rempeer 13 255.255.255.255 -d:134 -c:458 -p:3 -u:avf469`

Load IP Table

To load a program-specific DIP file from removable media to the `\sys\` directory of the control system, issue the `loadiptable` command.

- **Syntax:** `loadiptable -p:[appid] [path]`
 - `-p:[appid]`: The specific program identifier
 - `path`: The path of the file on removable media, including "\" (such as `\rm\tmpdir` or `\rm2\dipdir`)
- **Example:** `loadiptable -p:1 \rm\dipdir`

NOTE: The program must be restarted for the new IP table to take effect.

Run Multiple Programs

4-Series processors run multiple programs simultaneously to allow programmers to independently develop and run device specific programs for AV, lighting, HVAC, security, and so forth. As a system grows, processing resources can easily be shifted from one 4-Series processor to another without rewriting any code.

Device Registration Considerations

To keep the system running seamlessly, consider the following when stopping and starting programs:

- To ensure that devices are registered by the correct programs, note that programs restart in ascending order by program slot when the device is rebooted or when the `progreset` command is entered. For example, Program 1 starts before Program 2.
- Since most devices can only be registered by a single program, the first program to try registering the device succeeds. Subsequent attempts to register the device fail. If Program 1 registers a device, then Program 2 is not able to register it. Devices that fail to register can often be found in the log listed for that particular program that attempted to register it. For Ethernet devices, the IP Table will generally have a status of "NOT REG" due to a previous program registering the device first.

NOTE: This behavior does not apply when programs are started and stopped individually. For example, if the programmer stops all programs and restarts Program 10 before Program 1, Program 10 registers the device first.

- There are exceptions to this rule described in the bullet above, as some devices, slots, and ports can be registered by multiple programs. Refer to the following table to determine whether a particular control system slot or port is exclusive (can only be registered by one program) or shareable (can be registered by multiple programs).

NOTE: Within the following table, "shareable" means that all programs can access the device. "Exclusive" means only one program can ever register the device. Additional details provided in the **Status** column describe exceptions for how this device is handled by multiple programs.

Port and Slot Sharing

Slot or Port	Status
Expansion card cages	Shareable
BACnet	Exclusive
Built-in COM port	Slots are sharable but ports are exclusive (For example, Program 1 can register COM 2 while Program 5 registers COM 1, but both programs cannot register COM 2 at once.)

Slot or Port	Status
Built-in digital inputs	Slots and ports are shareable
Built-in relays	Slots and ports are shareable
Built-in RF gateway	Slots are sharable but individual devices are exclusive
Built-in system monitor	Sharable
Built-in Versiports	Slots are sharable, ports are sharable only if they have the same configuration

Run Programs from External Storage

Certain 4-Series control systems are equipped with external storage ports. On system boot or a hardware reset, the control system checks for any programs in external memory (if installed) before checking in internal flash.

To configure running programs from external storage, use the **Compact Flash** function in Crestron Toolbox. For more information, refer to the [Crestron Toolbox help file](#).

Primary-Secondary Mode

Primary-secondary mode is a network configuration that allows a 4-Series control system to access ports on other Crestron control systems over Ethernet. By attaching a secondary control system to a primary control system, the primary control system can use ports that it may not normally have (I/O, IR, RF, and so forth).

In a primary-secondary environment, the primary control system contains the program that controls all Cresnet and Ethernet devices attached to it. The secondary control system turns off its processing capabilities and behaves like any other Cresnet or Ethernet device. The secondary control system obeys the program running on the primary control system, making its ports available to the primary for control. Only one primary program needs to be written to control multiple secondary systems.

NOTE: If a control system must communicate with other control systems while running its own program, use the "Intersystem Communications" symbol for peer-to-peer communications between control systems over Ethernet. For more information, refer to the SIMPL or SIMPL# Pro help files.

Definitions

Depending on the communications capabilities of a control system, it may function as a Cresnet server, an Ethernet primary, or an Ethernet secondary.

NOTE: A 4-Series control system can be a secondary to a 3-Series or 4-Series control system. A 4-Series control system cannot be a secondary to a 2-Series control system.

Cresnet Server

When the control system is in Cresnet server mode (the default mode for 4-Series control systems), it can control Cresnet and Ethernet devices as well as 2-Series control systems operating in the Cresnet client mode. Control systems can function as a Cresnet server and an Ethernet primary simultaneously.

Ethernet Primary

When the control system is in Ethernet primary mode, it can control Ethernet and Cresnet devices as well as 2-Series, 3-Series, and 4-Series control systems operating in the Ethernet secondary mode.

Control systems can function as an Ethernet primary and a Cresnet server simultaneously.

Ethernet Secondary

When the control system is in Ethernet secondary mode, it operates as an Ethernet device and makes its ports (except for the LAN port) available to a primary control system. Any program loaded into the control system does not run when it is in Ethernet secondary mode.

NOTE: 3-Series and 4-Series control cards are not supported when the control system is in Ethernet secondary mode.

Primary-Secondary Configuration

Use the following console commands to configure primary-secondary mode parameters for the control system.

Add Primary Entry

To add a primary entry to the control system IP table, use the `addmaster` command.

- **Syntax:** `addmaster [cipid] -[ip_address/name]`
 - `cipid` - The ID of the CIP node (in hexadecimal format)
 - `ip_address/name` - The IP address (in dot decimal notation) or the name of the site for DNS lookup
- **Example:** `addmaster 1E -PRO4-IH`

Remove Primary Entry

To remove a primary entry from the IP table, use the `remmaster` command.

- **Syntax:** `remmaster [cipid] -[ip_address/name]`
 - `cipid` - The ID of the CIP node (in hexadecimal format)
 - `ip_address/name` - The IP address (in dot decimal notation) or the name of the site for DNS lookup
- **Example:** `remmaster 1E -PRO4-IH`

View Primary IP Table

To view the primary IP table, use the `mipatable` command. Append `[-t]` to the command to output the results in table format.

View Secondary Status

To display the status of the secondary control system, use the `slavestatus` command.

Response Reject Count for Secondary Connection

To set the default response reject count for the secondary control system connections, issue the `ethslvconnfcnt` command:

- **Syntax:** `ethslvconnfcnt [connectfailedcount]`
 - `connectfailedcount` - Sets the default secondary connect response reject count. The secondary stops connecting after this number of connect response rejections.
 - No parameter - Displays the current response reject count
- **Example:** `ethslvconnfcnt 6`

The `ethslvconnfcnt` command sets the number of response rejections that must occur following unsuccessful connection attempts before the secondary reverts back to its normal operating mode. The default count is 100, with each count occurring every 10 seconds.

For example, if the count is set to "6", the secondary would revert back to normal roughly a minute after the first response rejection.

This command can be used in a scenario where a particular IP address is active but does not have a program that listens to that ID.

Secondary Connection Timeout

To set the default timeout setting for secondary connection, use the `ethslvconntimeout` command:

- **Syntax:** `ethslvconntimeout [timeoutinsec]`
 - `timeoutinsec` - Sets the duration (in seconds) before the secondary connection times out and the secondary returns to its normal operating mode
 - No parameter - Displays the current timeout settings
- **Example:** `ethslvconntimeout 120`

The `ethslvconntimeout` command sets the timeout duration before the secondary reverts back to its normal operation mode if a TCP/IP connection to the primary cannot be established.

This command can be used in a scenario where a secondary attempts to connect to a nonexistent IP address or to a primary that is not running.

Functional Behavior

Observe the following regarding functional behavior for primary-secondary mode:

- When operating in Ethernet secondary mode, the control system can address any installed hardware, but it cannot address Ethernet devices.
- A 4-Series Cresnet server and 4-Series Cresnet client each have their own independent Cresnet bus, allowing the server to assign Cresnet IDs 03 to FE and the client to issue Cresnet IDs 03 to FE, ultimately doubling the number of devices in the network.

- A secondary 4-Series control system can only be configured to operate as an Ethernet secondary to another 3-Series or 4-Series control system. Cresnet secondary mode is not supported. A 2-Series control system can operate as a Cresnet client or Ethernet secondary to a 4-Series control system.

NOTE: There can only be one primary IP table entry.

- A 4-Series control system can switch back and forth between secondary mode and normal mode (running registered user programs) without requiring a restart. Parameters may be set using the `ethslvconnfcnt` command that determine how long the secondary controller tries to connect to the primary before reverting back to its normal operating mode.

The following behavior is dependent on whether a primary IP table entry exists when booting the system:

- No primary IP table entry is present when booting the system.
 - Adding a primary IP table entry allows the secondary to start connecting to the primary. Once the secondary is connected, all user programs stop executing, and the device enters into secondary mode.
 - Stopping the program on the primary does not force the secondary back into its normal operating mode. The secondary tries to connect for a set duration before reverting back to normal operations. After reverting, the secondary does not go back into secondary mode until the control system restarts or the primary IP table entry is added again.

NOTE: An Ethernet Slave - Reached max count of connect responses being rejected by master before a successful connect. Not retrying - Initiating normal behavior error is logged if this condition occurs.

- Removing the primary IP table entry forces the secondary control system to revert back to normal operations.
- A primary IP entry is present when booting the system.
 - The secondary tries to connect to the primary for a set duration.
 - If the secondary connects successfully, it enters secondary mode.
 - If the secondary does not connect successfully, it enters its normal operating mode. The secondary does not go back to secondary mode until the control system restarts or the primary IP table entry is added again.

Auto Update Mechanism

4-Series control systems provide an automatic update mechanism that centralizes updates on a remote server and allows devices to automatically download and update their respective components when updates are available. The centralized location can be a web server, a MyCrestron.com portal, or a private server.

Through the auto update mechanism, a control system can be scheduled to automatically download updates and can also trigger automatic updates for every device that it controls. The auto update mechanism will also periodically provide feedback to the user, including estimated time for updates, any failures, and successful updates.

Configure the Auto Update Mechanism

To turn on the auto update mechanism for the control system:

NOTE: This procedure assumes that a manifest file has already been created and is stored in a centralized location. For more information about the manifest file, refer to [Manifest File on page 252](#).

1. Issue the `auenable on` command.
2. Issue the `aumanifesturl [url]` command to set the URL for the remote manifest file, where `url` is the URL of the manifest file in the following format:

```
[http or sftp]://username:password@[hostname or ip]:port/path/file
```

3. Issue the `aupollinterval [interval_in_minutes]` command to set how often the control system polls the update server for updates.

NOTE: Control systems round up to the nearest hour.

4. Issue the `autime [time]` command to set the day of the week and time when the update manifest file should be read, where `TIME` is formatted as `[day_of_week]hh:mm`
 - `day_of_week`: Day of the week when the manifest file should be read
 - `hh:mm`: 24-hour time when the manifest file should be read
 - Specifying only `hh:mm` will make the update run every day at that time. For example, inputting `autime 11:00` will make the update run at 11:00 AM every day.
 - Specifying `day_of_week` with `hh:mm` will make the update run only at that day and time each week. For example, inputting `autime friday 11:00` will make the update run at 11:00 AM every Friday.
5. Issue the `auusername [username]` command to set a username for downloading automatic updates.
6. Issue the `aupassword [password]` command to set a password for downloading automatic updates.

Manifest File

The manifest file, which is JSON encoded, contains all the information required for scheduling and performing automatic updates on a 4-Series control system. The control system parses the manifest file, locates any required updates, and performs them in the order listed in the file. The manifest is always downloaded and parsed either at a scheduled time or from a forced action, which can be set from console commands.

The following shows an example of a manifest file JSON format:

```
[
  {
    "ControllerHostName": "ControllerHostname",
    "deviceHostname": "DeviceToUpdateHostname",
    "deviceModel": "Prompt",
    "deviceId": "XX",
    "indirectCresnetId": "XX",
    "controlSystemHostname": "ControlSystemHostName",
    "logFolder": "URL",
    "fileToUpdate": [
      {
        "fileUrl": "URL",
        "fileHashUrl": "URL",
        "fileType": "ACTION",
        "whenToDownload": "TIME",
        "whenToApplyUpdate": "TIME",
      }
    ]
  }
]
```

Overview of Manifest Parameters

The control system uses the following top-level parameters to determine which associated actions apply to it in order to initiate the auto update mechanism. At least one of these parameters must be defined, and they may contain wildcards for partial matching. A control system matches all specific values before taking the associated action.

NOTE: All keywords are case insensitive.

- `ControllerHostName` - The host name of the control system. Indicates that the following schema is meant for a control system. All non-control systems continue to parse the schema and act upon it if the details match.
- `deviceHostname` - The host name or IP address of an Ethernet device. This field will have different meanings depending on the operation to be performed (refer to [Description of Manifest Parameters on page 254](#)). If this parameter is omitted, the value will default to any.

- `deviceModel` - The device type of the target client and the physical transport (refer to [Description of Manifest Parameters on page 254](#)). If this parameter is omitted, the value will default to any.
- `controlSystemHostname` - The host name or IP address of a control system that is located in the client's IP table. If this parameter is omitted, the value will default to any.
- `deviceId` - The IP ID, Cresnet ID, or RF ID of the device (in hexadecimal format). This parameter can be displayed as a range (AA-ZZ) and/or as a list separated by commas (A,B,...Z).
- `Path` - Locates the path of a specific, generic device (without using a host name) within a system. Each path node consists of the following:
 - A letter identifying the specific subnet where the device or parent device(s) is located
 - C - Cresnet
 - E - Ethernet
 - R - RF
 - S - Slot
 - The subnet ID of the parent device

NOTE: The ID of the target device will always be specified in the device ID field and not the path. Therefore, the last path node will only consist of a subnet letter.

- The path may consist of several parent devices. In this case, each element is delimited by a colon.
- **Examples:**
 - A control system with an Ethernet to Cresnet bridge (at IP ID 03) that contains an EX gateway on Cresnet leg 1 (at ID A0) with a dim switch (at RFID 04) would have a path of "E03:C1.A0:R" and a device ID property of "04."
 - An EX gateway located on Ethernet (at ID 05) has a path of "E" and a device ID of "05."

The following top-level parameter is optional and is not necessary to complete the auto update process:

- `logFolder` - Each control system will create a result log file in this folder for each action. The URL must be an SFTP location. For more information, refer to [Results File on page 260](#).

The actions to be taken by the client are defined by the `filesToUpdate` array:

- `filesToUpdate` - The files associated with the action will be downloaded and installed in the order they are listed. The following parameters are used to describe each entry in the array and are required:

- `fileUrl` - The URL of the file to be downloaded. The control system must support parsing a full URL and downloads over HTTPS and SFTP: `[http or sftp]://username:password@[hostname or ip]:port/path/file`.
- `fileHashUrl` - The URL of the hash file. This hash is downloaded first and then compared to the previous hash that is cached locally on the control system.
 - If the hash in this file has changed, then the file defined in `fileUrl` will be downloaded and installed.
 - If the has in this file has not changed, then the file defined in `fileUrl` will not be downloaded and installed.
 - If no local hash cache exists, then the file will be downloaded.
- The client must support parsing a full URL and downloads over HTTPS and SFTP: `[http or sftp]://username:password@[hostname or ip]:port/path/file`.
- `fileType` - Determines how the control system will handle the file once it is downloaded. The value of this parameter must be one of the following predefined types, as undefined types are ignored by the client:
 - `"firmware"` - Firmware update file (.puf or .zip)
 - `"project"` - Standard VTZ project file
 - `"config"` - Text file containing a list of console commands to be executed
 - `"UserProgram"` - Indicates a user program

Description of Manifest Parameters

ControllerHostName

This parameter indicates the host name of the control system. The controller must support wild card characters "*" and "?", where "*" matches x number of characters and "?" matches exactly one character. A "*" indicates that all controllers will act upon a manifest schema, while a partial match can be used to limit the schema to a subset (for example, PRO-??).

Using these wildcard characters, the same manifest can be used across multiple control systems, which means that all control systems will try to update the devices specified based on the details in the manifest. While this method is recommended for Cresnet devices and devices on an internal gateway (since it is controller-specific), it could cause issues with Ethernet devices, as they can be accessed from multiple control systems.

Refer to the following best practices to manage the system properly:

- Cresnet and EX devices on the internal gateway can be safely updated when using "wildcards" for the controller host name.
- If updating Ethernet devices, it is recommended to specify device IDs so that the controller can be selective when updating.
 - The statement above assumes that the system is configured and that the IP table is set up correctly on the Ethernet devices. It also assumes that the devices follow the autodiscovery specification.
 - The above statement might not work for a first-time setup.
- If updating peripherals connected to an Ethernet-connected gateway or bridge, the user is responsible for managing the manifest file.

Control System Update Parameters

On a control system, a combination of "deviceId" and "deviceModel" indicates what device needs to get updated. The "deviceModel" always needs to be specified, since this parameter indicates the class of device and the corresponding plugin that handles the update. If "deviceId" is set to "any", all devices of the type specified by "deviceModel" will be updated.

DeviceId

Multiple devices that share the same type are often connected to the same control system. In this case, all of these devices can be updated using the "any" keyword. A single device can be updated using its specific device ID. If multiple device IDs need to be updated, multiple sections must be created in the manifest. To support this schema, the control system accepts a range and/or a list of the devices, which can be specified as follows:

- **List:** A comma separated list (3,4,78,95)
- **Range:** A continuous range of device IDs (5-15)
- **List and Range:** A combination of the above two methods (3,73,25, A-1E)

NOTE: The device IDs must be in hexadecimal format with no preceding "0x".

DeviceHostname

This parameter is only valid for an Ethernet device and can have multiple meanings:

- If the "deviceModel" specifies an Ethernet device, then the "deviceHostname" identifies the device to be updated. If the "deviceHostname" is the wildcard character "*", then it identifies all the Ethernet devices of the type specified by "deviceModel".
- For any combination of "deviceModel" and "deviceId", it needs to be established whether the device to be updated is on the controller or on a peripheral connected to the controller:
 - If the "deviceHostname" is defined, then the device to be updated is connected to an Ethernet-connected parent device.
 - If the "deviceHostname" is not defined, then the device to be updated is connected to the controller (Cresnet device/internal gateway).
 - If the "deviceHostname" is "*", then all devices will be updated as defined by the "deviceModel" parameter in one of the following three ways:
 - All gateways will be updated
 - All specific devices connected to internal/external gateways will be updated
 - All Cresnet devices of a specified type connected to a CEN-CN or all EX devices connected to an external Ethernet gateway will be updated.

IndirectCresnetId

This parameter is only valid when the "deviceModel" specifies an EX device:

- If the "deviceModel" specifies an EX device, then it indicates the Cresnet ID of the gateway.
- If "indirectCresnetId" is "*", then it indicates the specific device connected to any Cresnet gateway.
- If the value of this parameter is not defined, then the device to be updated is connected to the controller (Ethernet device/internal gateway).

UserPrograms

This parameter indicates that a user program should be updated. The following keywords are defined for this parameter:

- "programNumber" - Valid ranges are 1–10 or 1 only, and the range depends on the controller to be updated. The Program ID tag is intended for interactive systems only. The default value is "1".
- "programLocation" - Indicates whether the program needs to be loaded onto internal or external memory. The default value is "internal". For external memory, the controller loops through RM and RM2.

Sample Manifest File

The following shows a complete example of a JSON-encoded manifest file for a control system with multiple components. Note that actions are performed in the order they appear on the file.

```
[
  {
    "deviceHostname": "Room101-panel",
    "deviceModel": "TSW-770",
    "deviceId": "03",
    "controlSystemHostname": "192.186.1.1",
    "logFolder": "sftp://xxabet-xx2/html/Office-TouchPanel/results",
    "fileToUpdate": [
      {
        "fileUrl": "sftp://xxabet-xx2/html/Office-TouchPanel/xx.puf",
        "fileHashUrl": "sftp://xxabet-xx2/html/Office-TouchPanel/firmwareHash.txt",
        "fileType": "firmware",
        "whenToDownload": "Friday 23:00",
        "whenToApplyUpdate": "now",
      }
    ]
  }
]
{
  "deviceHostname": "Room101-panel",
  "deviceModel": "TSW-770",
  "logFolder": "sftp://xxabet-xx2/html/Office-TouchPanel/results",
  "fileToUpdate": [
    {
      "fileUrl": "sftp://xxabet-xx2/html/Office-TouchPanel/xx.ini",
      "fileHashUrl": "sftp://xxabet-xx2/html/Office-TouchPanel/configHash.txt",
      "fileType": "config",
      "whenToDownload": "Sunday 2:00",
    }
    {
      "fileUrl": "sftp://xxabet-xx2/html/Office-TouchPanel/xx.vtz",
      "fileHashUrl": "sftp://xxabet-xx2/html/Office-TouchPanel/projectHash.txt",
      "fileType": "project",
      "whenToDownload": "Sunday 2:00",
    }
  ]
}
{
  "ControllerHostName": "Crestron-PR04",
  "deviceModel": "PR04",
}
```

```

"logFolder": "sftp://xxabet-xx2/html/Office-PR04/results",
"fileToUpdate": [
  {
    "fileUrl": "sftp://xxabet-xx2/html/Office-PR04/program1.lpz",
    "fileHashUrl": "sftp://xxabet-xx2/html/Office-PR04/UpdaterHash.txt",
    "fileType": "userProgram",
    "ProgramNumber": "5",
    "ProgramLocation": "Internal",
    "whenToDownload": "Sunday 2:00",
  }
]
}
{
"ControllerHostName": "Crestron-PR04",
"deviceHostname": "Crestron-EXGateway",
"deviceModel": "CEN-GWEXER",
"logFolder": "sftp://xxabet-xx2/html/Office-PR04/results",
"fileToUpdate": [
  {
    "fileUrl": "sftp://xxabet-xx2/html/Office-PR04/GatewayFirmware.zip",
    "fileHashUrl": "sftp://xxabet-xx2/html/Office-PR04/GatewayHash.txt",
    "fileType": "firmware",
    "whenToDownload": "Sunday 2:00",
  }
]
}
{
"ControllerHostName": "Crestron-PR04",
"deviceHostname": "Crestron-EXGateway",
"deviceId": "10",
"deviceModel": "CLW-LDIMEX",
"logFolder": "sftp://xxabet-xx2/html/Office-PR04/results",
"fileToUpdate": [
  {
    "fileUrl": "sftp://xxabet-xx2/html/Office-PR04/CLWFirmware.zip",
    "fileHashUrl": "sftp://xxabet-xx2/html/Office-PR04/CLWHash.txt",
    "fileType": "firmware",
    "whenToDownload": "Sunday 2:00",
  }
]
}
{
"ControllerHostName": "Crestron-PR04",
"deviceId": "11",
"deviceModel": "CSM-QMT50-DCCN",
"logFolder": "sftp://xxabet-xx2/html/Office-PR04/results",
"fileToUpdate": [
  {
    "fileUrl": "sftp://xxabet-xx2/html/Office-PR04/ShadeFirmware.zip",
    "fileHashUrl": "sftp://xxabet-xx2/html/Office-PR04/ShadeFirmwareHash.txt",
    "fileType": "firmware",
    "whenToDownload": "Sunday 2:00",
  }
]
}
]

```

Manifest File Code Flow

The code flow of the auto update mechanism using the manifest file, as performed by the control system, is described below:

1. The control system downloads the manifest file at the predetermined day and time.
2. The control system parses the manifest file for applicable actions.
3. The control system verifies that the action is valid for itself and its current state. If not, the control system skips to step 8.
4. The control system downloads the hash file associated with the given action. If the hash file matches the hash cached on the control system, the control system skips to step 8.
5. The control system downloads the update file.
6. The control system applies the update file as directed. Retries are defined in the [Error Handling on page 262](#).
7. The control system updates the local copy of the hash if the update is successful.
8. If more actions are defined in the manifest, the control system returns to step 3.
9. The mechanism ceases once all actions defined in the manifest are completed.

Results File

The result of each action taken by the control system is uploaded to the location specified by the "logFolder" parameter that is associated with the action. Results filenames have the following syntax:

- [MAC_address_of_CS].[timestamp].[index].log
- **Example:** 00107f44901e.20190321_115636.1.log

When an action is performed, a result file is uploaded for each part of the action: When the action is downloaded, when the action starts, and when the action finishes. The timestamp is fixed at the initial step of the action and is expressed in "yyyyMMdd_HHmms" format.

It is the responsibility of the administrator to manage purging and storing these files as necessary. Using the 4-Series control system, this task can be accomplished via an automatic job that rotates the results files.

If any locations are inaccessible to the control system (for example, a downed server), then failure results are recorded in the client's error log. If the results location is accessible, a failure result is indicated in the results file and is uploaded to the results location.

Description of Results File Parameters

Use the following parameters inside the result files to identify the control system, the action taken, and the results of the action. The following parameters are always included in the result file:

- `clientModel` - The device type of the control system
- `updateAction` - The type of action taken by the control system
- `updateLog` - Indicates the section below that contains the actual log information for the preceding action
 - `fileName` - The name of the file that was downloaded
 - `fileHash` - The hash value associated with the file that was downloaded
 - `whenWasDownloaded` - The time the action started and the initial file was downloaded (in "HH:mm:ss" format)
 - `whenWasApplied` - The time when the update was applied (in "yyyyMMdd_HHmms" format)
 - `whenWasCompleted` - The time when the update was completed (in "yyyyMMdd_HHmms" format)
 - `result` - The result of the action, which is one of the following:
 - `success` - The action succeeded.
 - `error` - The action failed. See [Error Handling on page 262](#).
 - `estActionDuration` - The estimated time to complete the action (in seconds) where applicable

- `errorCode` - The error code number (if applicable)
- `errorText` - Any text that is associated with the error condition (if applicable)

The following parameters are dependent on the type of action taken:

- `numberOfSubActions` - The number of sub actions that are associated with the main action taken by the client.
- `subActions` - A sequence of sub action results that are associated with the main action taken by the client.
 - `command` - The console command executed by the client
 - `commandResult` - The result text returned to the console when executing a console command

The following is an example of a results file for a control system automatic update:

```
{
  "ControllerHostName": "Crestron-PR04",
  "deviceModel": "PR04",
  "updateAction": "firmware",
  "updateLog": [
    {
      "fileName": "xx.txt",
      "fileHash": "HASHCODE",
      "whenWasDownloaded": "2020-08-29T23:05:10Z",
      "whenWasApplied": "2020-08-29T23:15:10Z",
      "whenWasCompleted": "2020-08-29T23:25:10Z",
      "numberOfSubActions": "2",
      "subActions": [
        {
          "component": "eboot",
          "result": "success",
          "PreviousVersion": "1.001.0033",
          "CurrentVersion": "1.001.0034",
        }
        {
          "component": "updater",
          "result": "success",
          "PreviousVersion": "1.02.35",
          "CurrentVersion": "2.001.0034",
        }
      ]
    }
  ]
}
```

Error Handling

The following errors may be encountered during the auto update process. If the below solutions do not resolve the error, contact Crestron True Blue support via phone, email, or chat as described at www.crestron.com/Support.

- **File download fails:** the client is unable to download the hash file or the actual component
 - Retry the download on the next polling interval.
 - If download still fails, delete the hash file (The hash file was downloaded but not the actual component to the update).
- **Update operations:** The unzipping operation fails or the firmware component did not get updated.
 - Retry the operation.
- **Cannot resolve hostname:** The client cannot resolve the host name.
 - Check that the target host name is valid, and then retry resolving the host name on the next polling interval.
- **Cannot connect to the server/device:** The client cannot connect to the server or the device.
 - Check that the server or the device is currently accessible, and then retry connecting to the server or the device on the next polling interval.

A control system can handle errors in different ways depending on the component being updated and the dependencies between the components. The control system will do one of the following:

- **Abort the current operation.**

For example, if the control system is updating a .puf component, which has dependencies defined, and the first part of the update fails, the control system will abort this particular component and will continue to the next item in the manifest file.
- **Log the error and continue on to the next step.**

For example, if the control system is updating EX devices with the type "CLW-LDIMEX" and one device update fails, the controller will continue with the next set of devices.

Restore to Factory Defaults

If the control system is no longer communicating via USB or Ethernet, use the following procedure to restore the device to its factory default settings.

NOTE: This procedure erases the control system's firmware and reinstalls it. If problems persist before a SIMPL program is loaded, contact Crestron True Blue support via phone, email, or chat as described at www.crestron.com/Support. If the system locks up after a SIMPL or SIMPL# Pro program is loaded, there is likely an issue with the program.

1. Remove all wired connections from the control system.
2. Reconnect the power supply.
3. Use a small, pointed object (such as the tip of a pen) to press and release the **HW-R** button on the front of the control system.
4. Wait for the **MSG** or **ACQUIRE** LED to light on the control system roughly one second after pressing the **HW-R** button.
5. Use a small, pointed object (such as the tip of a pen) to quickly press the **SW-R** button on the front of the control system five times, with under a one-second gap between each press.
6. Wait up to 5–10 minutes for the self-recovery process to complete.
7. Attempt to make a connection to the control system over USB or Ethernet as described in [Establish Communications on page 205](#).
8. Once the device has been discovered, use the Text Console tool in Crestron Toolbox to check for a prompt. The standard device prompt should display.

NOTE: Repeat the procedure if the first attempt does not correct the issue. If the control system is still unresponsive, contact [Crestron True Blue support](#) for assistance.

Port Forwarding

Port forwarding can be used to provide connections from outside the local network for mobile and browser applications.

Observe the following points about port forwarding:

- Remap the external ports from the initial defaults. Remapping the external ports minimizes the number attempts that are allowed to access the system. A hacker will be unable to scan well-known ports for entry, and must instead scan all ports and then determine what protocols are supported before attempting to log in to the system.
- Most home routers allow different external and internal ports to be set. An example of a home router setup page is provided below.

Home Router Setup Page Example

Single Port Forwarding		External Port	Internal Port	Protocol	To IP Address	Enabled
Application Name	None	---	---	---	192 . 168 . 194 . 0	<input type="checkbox"/>
	None	---	---	---	192 . 168 . 194 . 0	<input type="checkbox"/>
	None	---	---	---	192 . 168 . 194 . 0	<input type="checkbox"/>
	None	---	---	---	192 . 168 . 194 . 0	<input type="checkbox"/>
	None	---	---	---	192 . 168 . 194 . 0	<input type="checkbox"/>
CIP		9699	41796	Both	192 . 168 . 194 . 99	<input checked="" type="checkbox"/>
SSH		2299	22	Both	192 . 168 . 194 . 99	<input checked="" type="checkbox"/>
eControl		4499	443	Both	192 . 168 . 194 . 99	<input checked="" type="checkbox"/>
Policy File		843	843	Both	192 . 168 . 194 . 99	<input checked="" type="checkbox"/>

- Use external port numbers that are not commonly used. The actual number is not important; it simply must match the entry in the mobile app configuration.
- Open ports that are required only. For example, if mobile applications or XPanel applications are used, open only the secure CIP port (default is 41796) and HTTPS port (default is 443). Ensure that SSL settings are used in the mobile application.
- If ports 41795 or 41797 were opened for external use, reroute the external ports to port 22 and use the SSH console.

Pairing a 4-Series Control System with Apple HomeKit Technology

Use the following procedures to pair a Crestron 4-Series control system with an Apple HomeKit technology system. Once the control system is paired with a HomeKit system via SIMPL Windows programming, a TSR-310 handheld touch screen remote can be used to control Apple TV® devices.

NOTE: Observe the following limitations when pairing a 4-Series control system with Apple HomeKit:

- The TSR-310 is capable of providing a defined set of commands to an Apple TV device. For more information, refer to [Joins and Parameters for Apple HomeKit Module on page 276](#).
- This feature is only available when using the TSR-310. Other Crestron touch screens, handheld remotes, and keypads are not supported. For these interfaces, traditional IR or CEC control must be used to control Apple TV devices.

This section provides the following information:

- [Prerequisites on page 266](#)
- [Pair with Apple HomeKit on page 267](#)
- [Setting Up Apple HomeKit with Crestron on page 274](#)
- [Joins and Parameters for Apple HomeKit Module on page 276](#)
- [Secure Device Deployment on page 277](#)

Prerequisites

The following prerequisites must be met prior to pairing the control system with an Apple HomeKit system.

NOTE: Software and firmware can be found in the Crestron.com [Resource Library](#). For information on accessing the library, refer to [OLH 1000579](#).

- One of the following 4-Series control system models running firmware version 2.4508.00035 or higher:
 - AV4
 - CP4
 - CP4N
 - DIN-AP4
 - MC4
 - PRO4
 - RMC4

NOTE: Crestron Home Processors Apple HomeKit integration can be found in the [Crestron Home OS Product Manual](#).

- A TSR-310 running firmware version 1.003.0050 or higher
- An iOS® 12 hardware device with the Apple Home app installed. The Apple Home app must be associated with the customer's Apple ID.
- A PC with the latest versions of the following:
 - Crestron Toolbox software
 - SIMPL Windows
 - Device Database
 - Crestron Database

Pair with Apple HomeKit

Before attempting the procedures described in this section, confirm the following:

- All Crestron devices have been updated to the latest firmware and all other prerequisites have been met. For more information, refer to [Prerequisites on page 266](#).
- The 4-Series control system, TSR-310, iOS device, and PC running Crestron software are all connected to the same network. The network must also support multicast for the Bonjour® networking protocol.
- The 4-Series control system must have internet access and must have DNS (Domain Name System) enabled.
- The 4-Series control system must be registered to a MyCrestron account prior to pairing it with Apple HomeKit. To register the device, visit <http://portal.my.crestron.com>, select **Add Device** from the **Devices** tab, and then follow the provided instructions.
- The iOS device is associated with the customer's Apple ID. All Apple TV and iOS devices must be logged into the same Apple ID, and all Apple TV devices must be added to Apple HomeKit using the Apple Home app.

NOTE: Only a single program on a control system can use Apple HomeKit.

Prepare the Control System for Pairing

To prepare the 4-Series control system for pairing with Apple HomeKit:

1. Open Crestron Toolbox software and establish a connection to the control system to review the firmware version and IP address.
2. Using the 4-Series Control System's web configuration, enable the **Apple HomeKit** toggle. For more information, refer to [Apple HomeKit on page 183](#).
3. In the **Action** menu, select **Save Changes**. A **Reboot** dialogue box will appear.

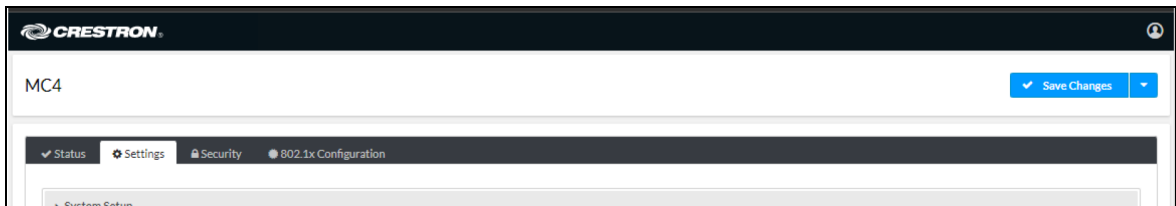

4. Select **Yes, Reboot Now**.

When the processor completes the reboot, it is ready for pairing.

Create and Load a HomeKit Program

An Apple HomeKit program must be created in SIMPL Windows using the Apple HomeKit module and loaded to an open program slot on the control system. The Apple HomeKit module acts as a SIMPL interface for controlling Apple TV devices.

NOTE: The Apple HomeKit module is used in conjunction with the Apple TV Control Reserved Joins device extenders described below.

To create the Apple HomeKit program:

1. Open SIMPL Windows and create a new program.
2. Add a TSR-310 device to the program.
3. Right-click the TSR-310 and add the **Apple TV Control Reserved Joins** device extender to the TSR-310 symbol.

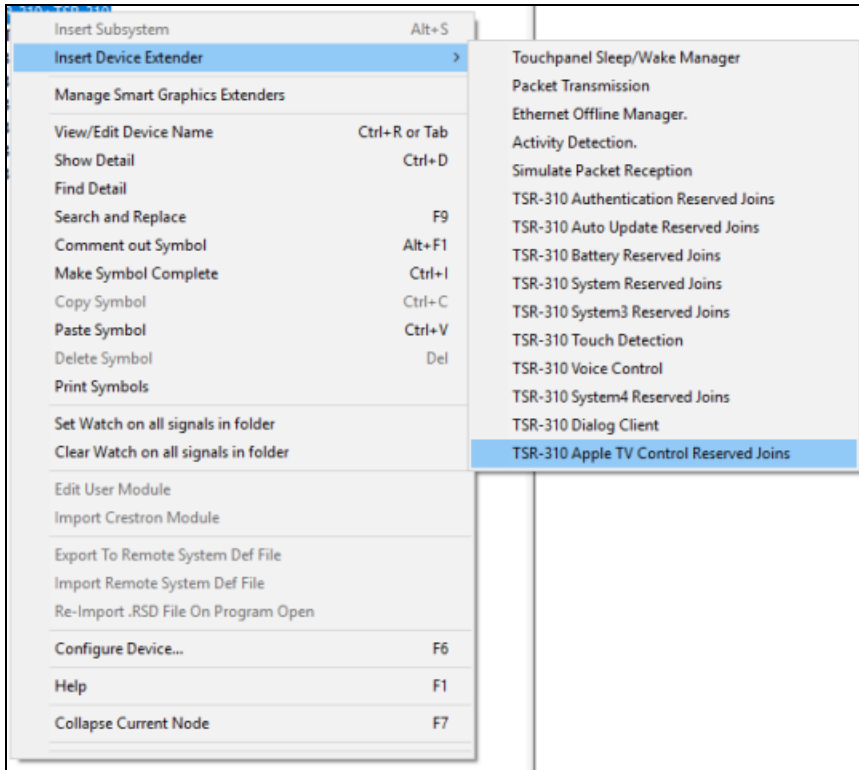

4. Add the Apple HomeKit module to the program.

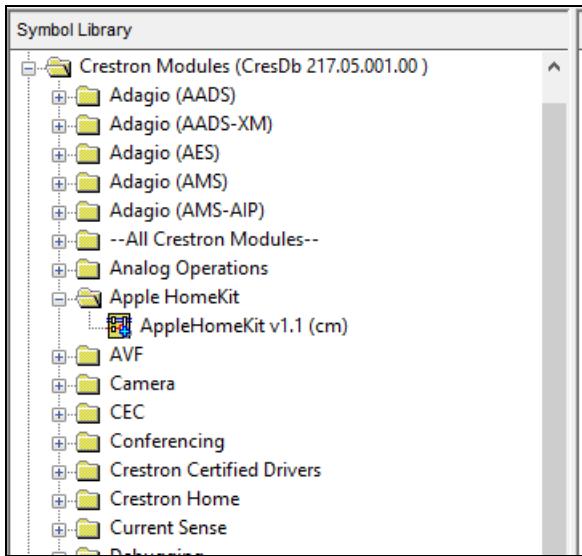

5. Connect the digital feedback signals from the extender to the module. The names of the signals should match. (For example, **Up_fb** on the extender should be connected to the **Up** input on the module.)
6. Select the **Serial** tab on the extender, and then connect the **Data_fb** signal to the **Voice_Data** input on the module.
7. Connect the **Apple TV Select** analog input on the module to a driving source (such as the analog join of a dynamic list SmartObject® software item). For more information, refer to [Joins and Parameters for Apple HomeKit Module on page 276](#).
8. Enter the appropriate data into the **Remote Name**, **Remote ID**, and **Serial Number** parameter fields. For more information, refer to [Joins and Parameters for Apple HomeKit Module on page 276](#).
9. Connect the **Identify** output signal on the module to the **Identify** input signal on the extender. This signal is used to trigger the identify routine on the TSR-310 via the identify button for the remote on the Apple Home app.

Once programming is complete, upload the compiled program to an open slot on the control system using Crestron Toolbox. For more information, refer to the [Crestron Toolbox help files](#).

Connect the TSR-310 to the Control System

The TSR-310 device(s) that will be used to control Apple TVs via Apple HomeKit must be connected to the control system via the IP table associated with the SIMPL Windows program.

To connect the TSR-310 to the control system:

1. Use the **SSL Management** function in Crestron Toolbox or the `ssl` console command to configure SSL on the TSR-310. For more information, refer to [Secure Device Deployment on page 277](#).

2. Connect the TSR-310 to the control system's IP table as described in the [TSR-310 Supplemental Guide](#). Ensure that the IP ID used matches the IP ID used in the SIMPL Windows program.
3. Confirm that the TSR-310 is connected to the control system using the correct IP ID by issuing the `IPT` console command to the TSR-310

Complete the Pairing

To connect the Apple HomeKit system to the control system:

1. Open the Apple Home app on the customer iOS device. This iOS device must be associated with the customer's Apple ID, as the control system will be paired to the Apple ID associated with the iOS device used for pairing.
2. Select **Add Accessory**.

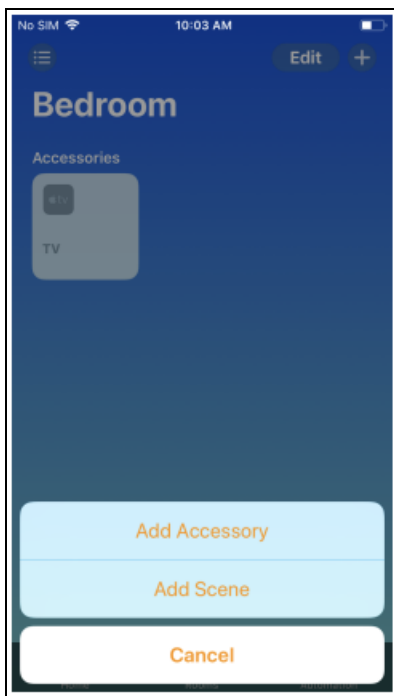

3. Scan the QR HomeKit Setup Code. This is found on a sticker attached to the 4-Series Control System.

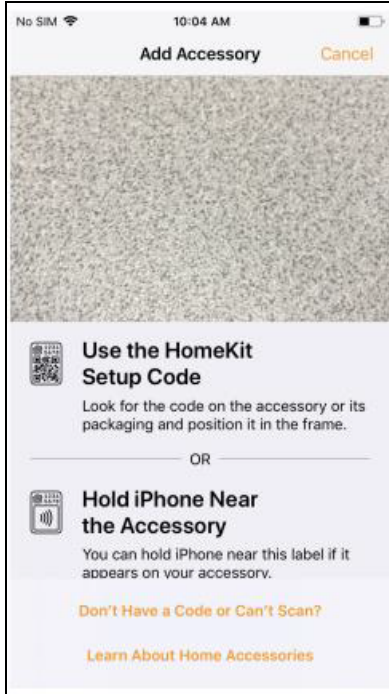

4. Under **Nearby Accessories**, select **Crestron Bridge**.

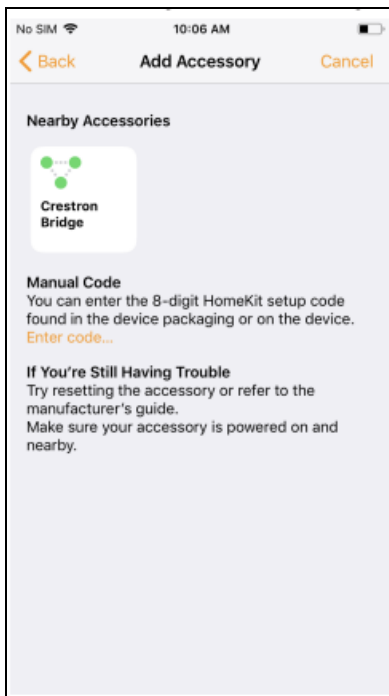

5. If there are any difficulties scanning the QR code, use this alternative procedure:
 - a. Select **More Options....**
 - b. Select **My Accessory Isn't Shown Here.**
 - c. Select **Enter Code....**
 - d. Enter the HomeKit code printed on the QR code sticker.

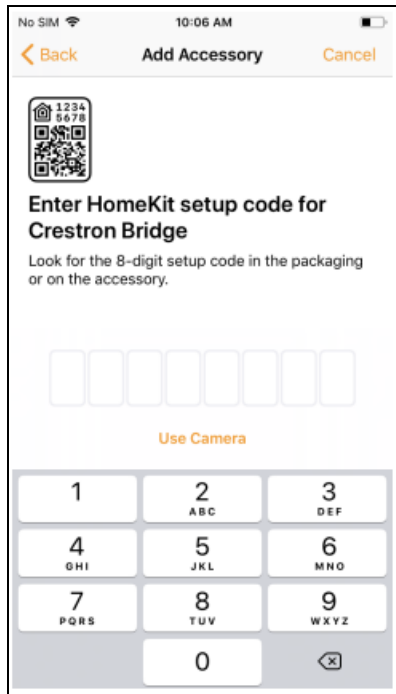

Once the 4-Series Control System is paired with Apple HomeKit, a **Connected** message showing the connected remote name(s) is displayed on the Apple TV devices configured for control.

The image below shows an example of a successful connection message for a remote named **Demo1**.

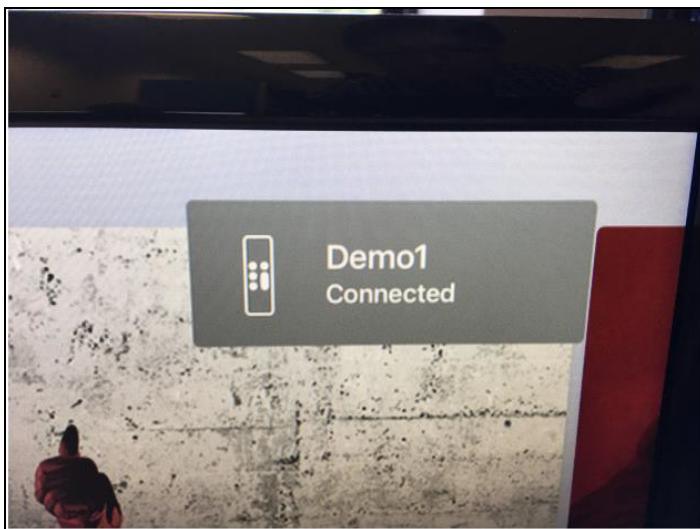

If the Apple TV device cannot be controlled after this message is displayed, ensure that the TSR-310 has been configured as described in [Connect the TSR-310 to the Control System on page 269](#).

Setting Up Apple HomeKit with Crestron

To complete the set up, follow the procedure below.

NOTE: Use the customer's Apple devices to complete this procedure.

Configure the Apple TV

Follow the instructions below. Use the remote supplied with the Apple TV.

1. Navigate to **Settings**.
2. Under **General**, configure the following settings:
 - a. **About:** Set the name for the Apple TV. This name will appear in the HomeKit app.
 - b. **Sleep After:** Set to **Never**.
 - c. **Users and Accounts:** Sign in using the customer's Apple ID and password.
3. Under **AirPlay and HomeKit**, configure the following settings:
 - a. **AirPlay:** Set to **On**.
 - b. **HomeKit:** Select the room that the Apple TV is in. Verify that the correct Apple TV name is displayed.
 - c. **HomeHub:** Set to **Disable**.

The Apple TV is now ready.

Configure the iCloud Keychain

The customer's Apple ID must be configured for iCloud Keychain. For more information, refer to [Apple's instructions](#).

Verify the Connection Between Apple Devices

The Apple TV should now appear in the Apple Home app. Verify that the Apple TV can be controlled successfully through the Apple Home app by following the steps below.

1. Open the Apple Home App. The Apple TV should appear as a tile in the room defined during setup.

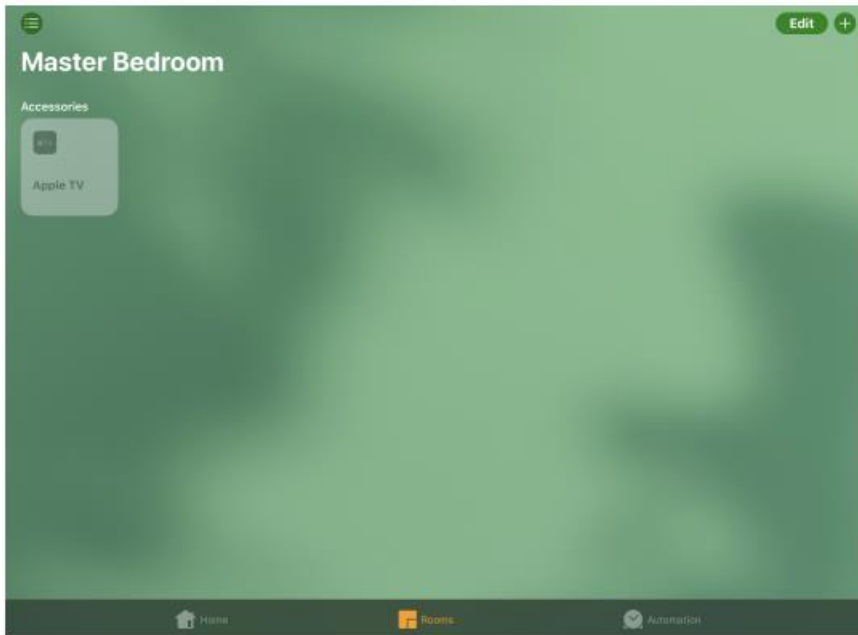

2. Use the remote control supplied with the Apple TV to start playing a video. In the Apple Home app, the Apple TV icon should indicate that a video is playing.
3. Control the video using the Apple Home app:
 - a. Select the icon to pause the video. The icon should indicate that the video is paused. Verify that the video on the display is paused.
 - b. Select the icon again to play the video. The icon should indicate that the video is playing. Verify that the video on the display is playing.

If the Apple devices are not communicating, refer to [Apple's support page](#).

Joins and Parameters for Apple HomeKit Module

Refer to the table below for the joins and parameters that are compatible with the Apple HomeKit module in SIMPL Windows.

Joins and Parameters for Apple HomeKit Module

Join Type	Input/Output	Name	Description
Digital	Input	Up	Up command
Digital	Input	Down	Down command
Digital	Input	Left	Left command
Digital	Input	Right	Right command
Digital	Input	Select	Select command
Digital	Input	Guide	Guide command (acts as the Home button)
Digital	Input	Menu	Menu command
Digital	Input	Exit	Exit command (acts as the Menu command)
Digital	Input	Play	Play/pause command
Digital	Input	Pause	Play/pause command
Digital	Input	Stop	Play/pause command
Digital	Input	Rewind	Left command
Digital	Input	Fast_Forward	Right command
Digital	Input	Mic	Mic button down
Digital	Input	Restore	Restores HomeKit to factory settings (removes pairing)
Serial	Input	Voice_Data	Voice data
Analog	Input	Apple_TV_Select	Selects the Apple TV (values ranged from 1 to 32 based on alphabetical order of devices). Sending 0 clears the selection.
Digital	Output	ReadyState	Shows if the TSR-310 is online with HomeKit and can control the Apple TV.
Digital	Output	IdentifyRemote	Triggers the identify routine on the TSR-310
Analog	Output	Selected Target	Indicates the currently selected Apple TV (values ranged from 1 to 32 based on alphabetical order of devices). 0 indicates no selection.
Serial	Output	Apple_TV_Name1_FB	Name of the 1st Apple TV
Serial	Output	Apple_TV_Name_[N]_FB	Name of the N th Apple TV, where N is the ordered number of the device.
Serial	Parameter	RemoteName	TSR-310 device name
Serial	Parameter	RemoteID	TSR-310 remote ID (ranging from 2 to 255)
Serial	Parameter	SerialNumber	TSR-310 serial number

Secure Device Deployment

Perform the procedures described in this section to secure the TSR-310 for integration with Apple HomeKit.

NOTES:

- This procedure assumes that the user is familiar with operating Crestron Toolbox software. For more information on operating Crestron Toolbox, refer to the [help files](#).
- 4-Series Control Systems are already secure.

Secure the TSR-310

Follow the procedure below to secure the TSR-310.

1. Connect to the TSR-310 in Crestron Toolbox.
2. Open the **Text Console** tool.
3. Issue the `SSL NOVERIFY` command to enable SSL.
4. Supply the username and password for the control system CIP connection with the `SETCSAUTHENTICATION -N:[username] -P:[password]` command.
5. Reboot the TSR-310.

The TSR-310 is now secure.

Resources

The following resources are provided for 4-Series® Control Systems.

NOTE: You may need to provide your Crestron.com web account credentials when prompted to access some of the following resources.

Crestron Support and Training

- [Crestron True Blue Support](#)
- [Crestron Resource Library](#)
- [Crestron Online Help \(OLH\)](#)
- [Crestron Training Institute \(CTI\) Portal](#)

Programmer and Developer Resources

- help.crestron.com: Provides help files for Crestron programming tools such as SIMPL, SIMPL#, and Crestron Toolbox™ software
- developer.crestron.com: Provides developer documentation for Crestron APIs, SDKs, and other development tools

Product Certificates

To search for product certificates, refer to support.crestron.com/app/certificates.

Related Documentation

- [4-Series™ Control Systems Security Reference Guide](#)
- [.AV Framework™ Software for 4-Series Control Systems Reference Guide](#)
- [Crestron Fusion® Software Help File](#)
- [Crestron Programming Design Guide](#)
- [Crestron Virtual Control Server Software Product Manual](#)
- [REST API for Crestron Virtual Control Programming Guide](#)
- [XiO Cloud® Service User Guide](#)

This page is intentionally left blank.

