



McIntosh Laboratory, Inc. 2 Chambers Street Binghamton, New York 13903-2699 Phone: 607-723-3512 www.mcintoshlabs.com

MHT300

A/V Receiver
Owner's Manual





Thank You from all of us at McIntosh

You have invested in a precision instrument that will provide you with many years of enjoyment. Please take a few moments to familiarize yourself with the features and instructions to get the maximum performance from your equipment.

If you need further technical assistance, please contact your dealer who may be more familiar with your particular setup including other brands. You can also contact McIntosh with additional questions or in the unlikely event of needing service.

McIntosh Laboratory, Inc.

2 Chambers Street
Binghamton, New York 13903

Technical Assistance (607) 723-3512
Fax (607) 724-0549

Customer Service (607) 723-3515
Fax (607) 723-1917

Email support@mcintoshlabs.com
www.mcintoshlabs.com

Please Take A Moment

For future reference, you can write down your serial number and purchase information here. We can identify your purchase from this information if the occasion should arise:

Serial Number: _____

Purchase Date: _____

Dealer Name: _____

Safety First

Please read the safety instructions included in a separate document called **Important Additional Operation Information Guide**.

What is in the box

Here is what is in the box besides all the shipping materials:

- One MHT300 A/V Receiver
- One accessory package including:
 - Microphone with attached cable
 - Microphone stand
 - ½ inch male to ⅝ inch female adapter
- One hardware package including:
 - Two Side Rack Mounting brackets
 - Four flat head Philips screws 6-32x¼"
 - Four Philips screws 8-32x⅜"
- One manual package including this manual
- One HR085 Remote Control
- One AC power cord
- One McIntosh wrench

Introduction

Now you can take advantage of traditional McIntosh standards of excellence in the MHT300. The MHT300 Audio/Visual Receiver marries a long tradition of uncompromising quality with the latest home theater technologies to bring you an unsurpassed luxury entertainment experience. The McIntosh sound is "the sound of the music itself."

Outdoor Antenna Grounding

If an outside antenna or cable system is connected to the product, be sure the antenna or cable system is grounded so as to provide some protection against voltage surges and built-up static charge.

Article 810 of the National Electrical Code, ANSI/NFPA 70, provides information with regards to proper grounding of the mast and supporting structure, grounding of the lead-in wire to an antenna discharge unit, and size of ground conductors, location of antenna-discharge unit, connection to ground electrodes and requirements for the grounding electrode.

Example of antenna grounding as per National Electrical Code, ANSI/NFPA 70

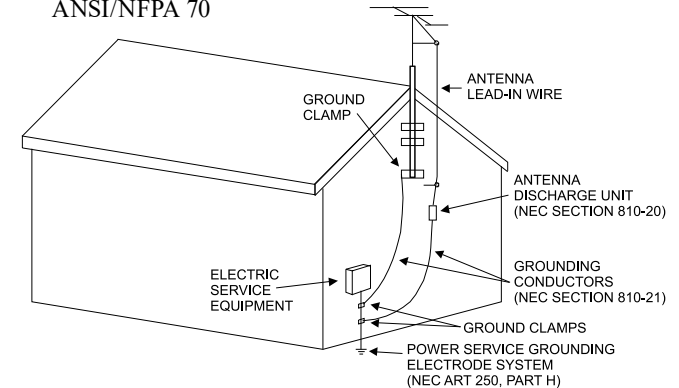



Performance Features

• Special Power Supply

High speed switching power supply provides stable high efficiency noise free operation.

• McIntosh Custom Binding Posts

McIntosh patent pending gold plated output terminals deliver high current output. They accept large diameter wire and spade lugs. Banana plugs may also be used **only in the United States and Canada.**

• Front Panel Illumination

The even illumination of the front panel is accomplished by the combination of custom designed light diffusers and extra long life Light Emitting Diodes (LEDs).

• Glass Front Panel Display

The famous McIntosh illuminated glass front panel display uses a 2 x 20 character vacuum fluorescent display to indicate various operational setup and status notices.

• Special FM RF Circuitry

The MHT300 RF circuitry receives strong local FM station signals without distortion and receives even the weakest of FM signals with low noise.

• Remote Control with External Sensor Input

The HR085 Remote Control provides control of the MHT300 operating functions and other McIntosh source components. Enjoy your McIntosh system from other rooms in your home by connecting external sensors.

• Power Guard

The McIntosh power guard circuit prevents the amplifier from being over driven into clipping, with its harsh distorted sound that can damage your valuable loudspeakers.

• Sentry Monitor and Thermal Protection

McIntosh sentry monitor power output stage protection circuits ensure the MHT300 will have a long and trouble-free operating life. Built-in thermal protection circuits guard against overheating.

Table of Contents

Introduction	2
Performance Features	3
Dimensions	4
Custom Installation	5
Trademark and License Information.	5
Front Panel	6
Rear Panel Inputs	7
Rear Panel Outputs	7
Connector and Cable Information	8
Connecting a Loudspeaker	9
Navigating the Remote Control.. . . .	10
How to use the Remote Control	11
Trim Menu	12
Setup Menu	14
Inputs Setup Menu	15
General Setup Menu	16
Audio Setup Menu	18
Video Setup Menu	20
Network Setup Menu	21
Speakers Setup Menu	22
Dirac Live® Setup.	24
Connection Diagram	25
Setting Up Surround Sound	26
Tuner Setup Menu	28
Navigating the Tuner Input.	29
Amplifier Audio Specifications	30
Packing Instructions	31
Part List	31



Dimensions

The MHT300 needs to be placed upright on its four feet. It also can be custom installed, see the following page for details.

It is necessary to provide adequate ventilation for cool operation, ensuring long life for the MHT300.

The following dimensions can assist in determining the best location for your MHT300.

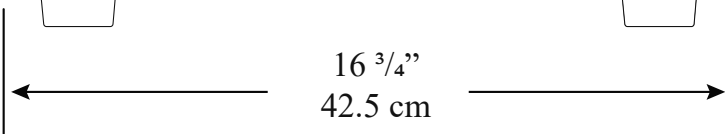
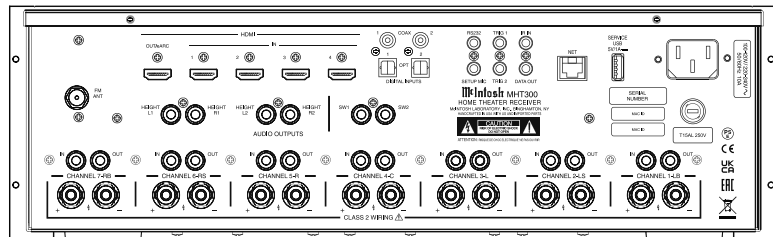
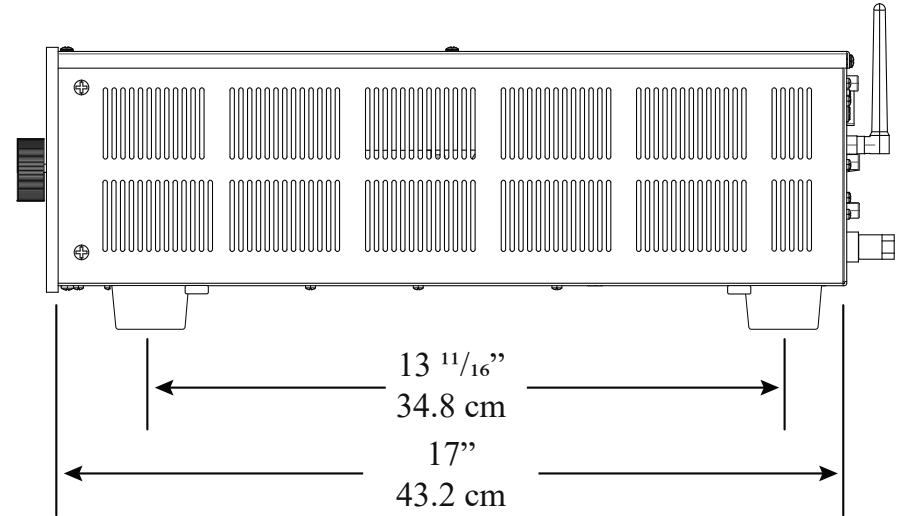
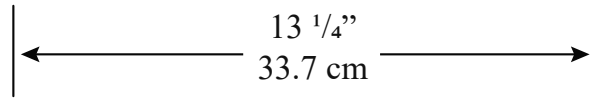
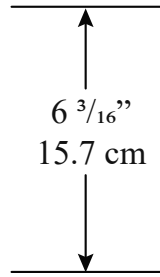
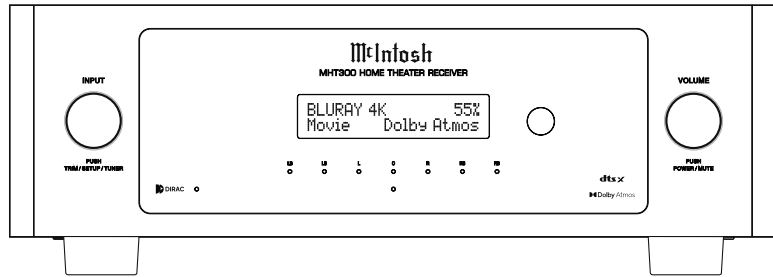
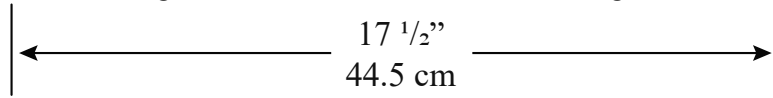

Custom Installation

Remove the four feet when installing the MHT300 and retain them with the fastening screws for possible future use. Do not install the MHT300 above heat generating components. When the MHT300 is installed in a cabinet with other components, use a ventilation fan to provide cool operating temperature.

- 3 inches (7.6cm) above the top
- 3 inches (7.6cm) below the bottom
- 3 inches (7.6cm) on each side so that airflow is not obstructed
- 1 $\frac{7}{16}$ inch (2.5cm) in front of the mounting panel for knob clearance

Rack Mounting

To rack mount the MHT300, the two included side rack mounting brackets should be installed.

Follow these instructions for each side:

1. Remove the two screws from the front side of the MHT300's side panel. Save these for future use if the mounting brackets are removed.
2. Secure the side rack mounting bracket to the MHT300 using the larger supplied screws. Do not re-use the previously removed screws. Use the smaller supplied screws to secure the bracket to the front panel.

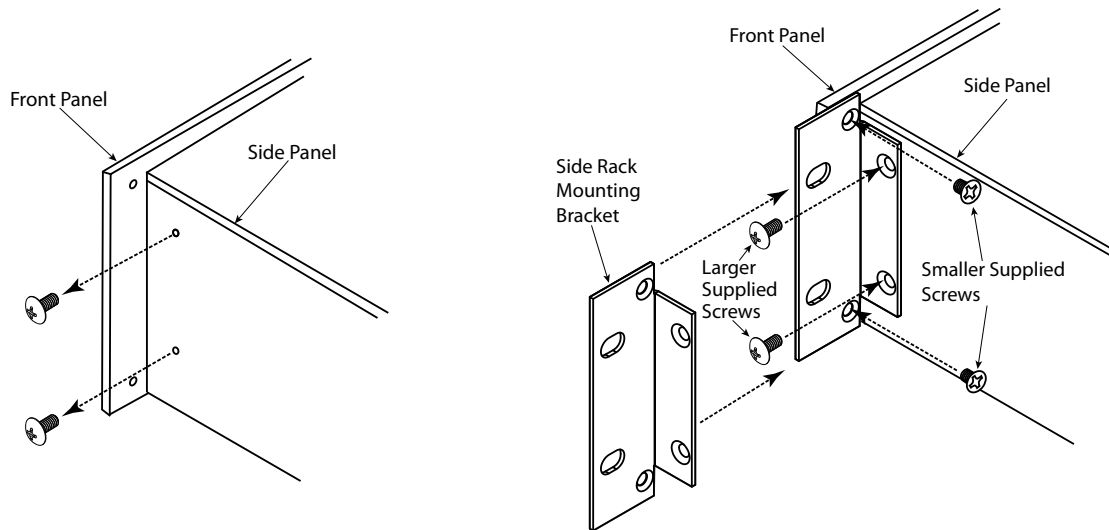

Trademark and License Information

The McIntosh MHT300 incorporates copyright protected technology that is protected by U.S. patents and other intellectual property rights. The MHT300 uses the following technologies:

Trademark Logo	License Information
	Dolby, Dolby Atmos, and the double-D symbol are registered trademarks of Dolby Laboratories Licensing Corporation. Manufactured under license from Dolby Laboratories. Confidential unpublished works. Copyright © 2012-2020 Dolby Laboratories. All rights reserved.
	The terms HDMI, HDMI High-Definition Multimedia Interface, and the HDMI Logo are trademarks or registered trademarks of HDMI Licensing Administrator, Inc.
	Manufactured under license from Dirac Live. Dirac Live, Dirac® and Dirac Live® are trademarks owned by Dirac Research AB.
	For DTS patents, see http://patents.dts.com . Manufactured under license from DTS Licensing Limited. DTS, DTS:X, and the DTS:X logo are registered trademarks or trademarks of DTS, Inc. in the United States and other countries. © 2021 DTS, Inc. All rights reserved.



Front Panel

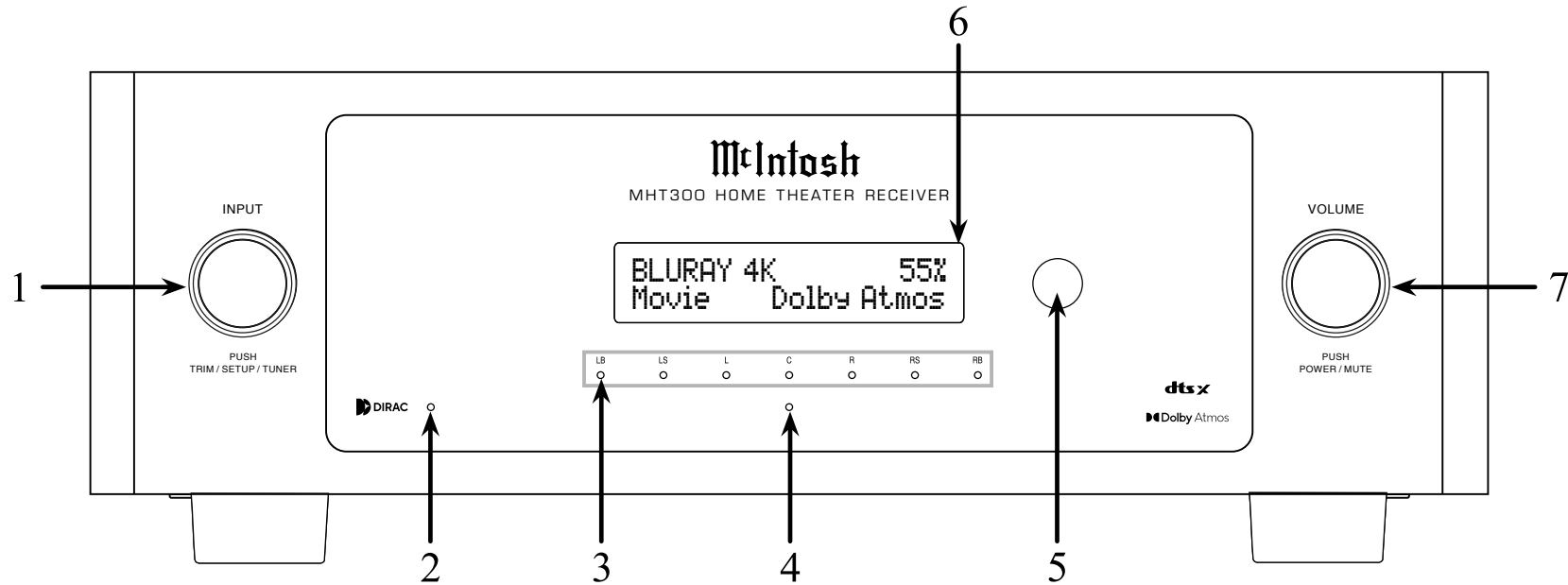

Front Panel

1. INPUT KNOB is used for the following:

- **Input Selection:** Turn clockwise or counter-clockwise to scroll through inputs.
- **Tuning Mode:** With the tuner input selected, quickly double press to enter Tuning Mode and rotate the input knob to navigate through stations.
- **Trim Menu:** Push and release to enter Trim Mode and rotate to navigate through options.
- **Setup Menu:** Push, hold for two seconds, and release to enter setup mode.

2. Dirac Live LED shows whether Dirac Live EQ is engaged, LED will be lit, or disengaged, LED will not be lit.

3. LB, LS, L, C, R, RS, RB LED lights show fault states for each amplifier channel.

LED Color	Functional Status
Amber	Indicates when maximum power output for the channel has occurred with prevention of audio clipping
Red	Indicates current limit or short circuit for the channel loudspeaker output connection

4. Standby LED indicates AC connection and current power status.

5. IR Sensor receives commands from the HR085 remote control.

6. VFD (Vacuum Fluorescent Display) 2 x 20 character screen shows various messages for setup/trim and playback conditions.

7. VOLUME KNOB is used for the following:

- **Power ON:** Quick press to power on the MHT300.
- **Adjust Volume:** Rotate to adjust the volume.
- **Mute:** Quick press to toggle mute on or off.
- **Setup/Trim:** Rotate to adjust Trim options once the menus are accessed using the INPUT knob.
- **Power OFF:** Push and hold for 2 seconds to power down the MHT300. POWER OFF will appear on the display.

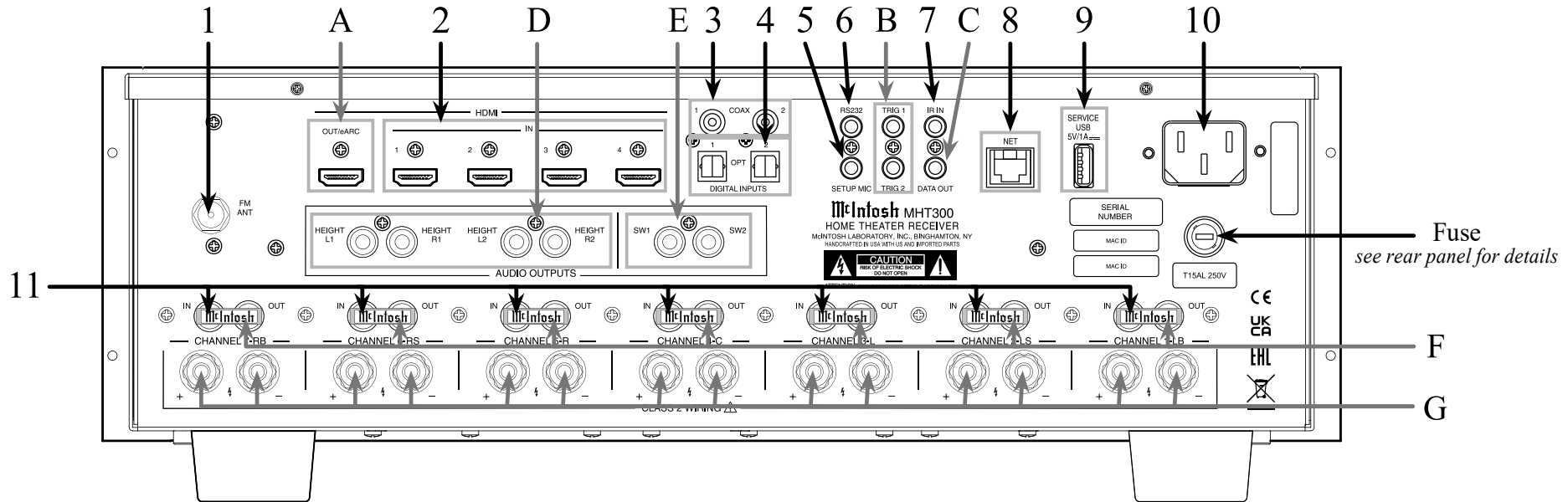

Rear Panel Inputs

1. One FM Antenna
2. Four HDMI IN
3. Two coaxial digital audio inputs
4. Two Toslink optical inputs
5. One 1/8 inch jack for microphone input
6. One 1/8 inch jack for RS232 connector
7. One 1/8 inch jack for wired IR input
8. One 10baseT LAN connector
9. One USB upgrade service port
10. One AC power connector
11. Seven unbalanced amplifier inputs

Rear Panel Outputs

- A. HDMI Out / eARC
Note: Acts as an audio input when ARC is active.
- B. Two 1/8 inch jack power control (trigger) outputs
- C. One 1/8 inch DATA OUTput jack
- D. Four additional outputs are available for Height speakers via separate amplifiers:
 - HR1 (Height Right 1)
 - HL1 (Height Left 1)
 - HR2 (Height Right 2)
 - HL2 (Height Left 2)*Note: HR1 and HL1 should be forward of HR2 and HL2. The MHT300 support of Height speakers is limited to Top Front, Top Middle and Top Rear locations.*

- E. Two subwoofer outputs are available to connect to powered subwoofers.
 - SW1 (Subwoofer 1)
 - SW2 (Subwoofer 2)
- F. Seven pre-configured unbalanced connections:
 - FR (Front Right)
 - FL (Front Left)
 - C (Center)
 - SR (Surround Right)
 - SL (Surround Left)
 - SBR (Surround Back Right)
 - SBL (Surround Back Left)
- G. Speaker outputs



Connector and Cable Information

Power Control Connectors

The MHT300 TRIG 1 & 2 outputs on the rear panel send power on/off signals when connected to other McIntosh components. A 3.5mm stereo mini plug is used for connection to the trigger outputs on the MHT300.

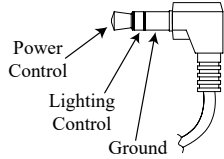

Data Out Connector

The MHT300 will convert IR remote control data to share with McIntosh components connected to the DATA OUT port on the rear panel. This will allow the operation of primary functions of a source to be operated with the MHT300's remote control as well as allow units that are out of range of an IR signal to receive commands.

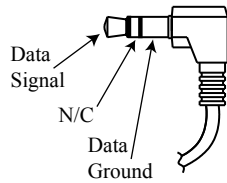

NET Port (Ethernet / 10baseT LAN)

Use an Ethernet cable to connect the MHT300 to a network router. The network connector is located on the rear panel of the MHT300 to the left of the CAUTION label. It is labeled NET.

By default, the MHT300 has DHCP set to ON and will automatically receive an IP address from the router. This setting can be changed.

HDMI

The MHT300 has four HDMI inputs capable of 8K video. To take advantage of this new capability, the use of certified “Ultra High Speed HDMI” cables according to the 2.1 HDMI specification is recommended. This would include support for 8K@60Hz, HDR, Ethernet, and ARC. Although HDMI is backward compatible, older cables may have issues with the higher bandwidth.

Use the HDMI OUT/eARC port when connecting to an ARC (Audio Return Channel) enabled television.

ARC can provide two-way communication between units allowing for volume control and lip-syncing functions to ensure audio and video are perfectly matched. This allows for more intelligent operation between components as well as less cable clutter. Make sure the ARC is enabled in your TV's setup menu.

The MHT300 supports eARC which allows for even higher bandwidth and will allow for higher quality audio including uncompressed 7.1 surround, Dolby Atmos and DTS:X.

USB

There is a USB type-A port on the rear panel of the MHT300 which is labeled USB 5V/1A. The USB port is used for firmware upgrades and to save and restore MHT300 setup information. **The USB port is not for general USB use or charging devices.**

Amplifier Jumper Connectors

The MHT300 utilizes 7 phono style jumper connectors to make a signal connection between the preamplifier outputs of the MHT300 and the built in power amplifier inputs. The McIntosh jumpers come pre-installed. The jumper connections may be removed in order to configure other amplifier models with the processor section to further customize your playback system.

Note: The Jumper Connector is available from the McIntosh Parts Department:

McIntosh Jumper Connector Part No. 117781

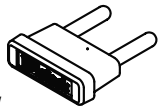

FM Antenna

The MHT300 FM tuner circuitry requires the connection of an external Antenna for FM reception. Port (1) accepts a 75 Ohm Coaxial Type F connection.

Microphone

The SETUP MIC input is for connecting the supplied MHT300 Microphone using the microphone's attached cable and a 3.5mm connector. The microphone is used in the Dirac Live® calibration for tuning the system to your room. For instructions see “Dirac Live® Setup” on page 24.

Connector and Cable Information (continued)

IR IN Port Connector

The IR input allows an external IR receiver to be attached to the MHT300. The input is labeled IR IN. By attaching an IR receiver using a 3.5mm cable, the remote control can be used in another location without a line-of-sight to the MHT300's front IR sensor. The IR input is configured for non-McIntosh IR sensors such as a Xantech Model DL85K Kit.

Note: The IR receiver must provide its own power supply.

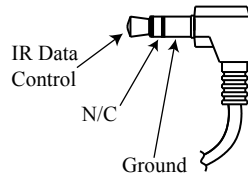

RS232

The RS232-C Data Cable is a 3.5mm stereo mini plug used to connect to external third party controllers.

Typical RS232 settings are:

- -8 data bits, no parity and one stop bit
- -Baud rate fixed at 115,200 bits per second

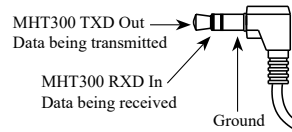

AC Power

This connection is essential. Plug the supplied power cord into the AC connector located in the rear right corner of the MHT300 and into a grounded and functioning AC outlet.

Output Terminals

When connecting the loudspeaker hookup cables to the MHT300 amplifier output terminals please follow the steps below:

1. Rotate the top of the output terminal Post counterclockwise until an opening appears.
2. Insert the loudspeaker hookup cable into the output terminal post opening or the cable spade lug around the center post of the output terminal.
3. Rotate the top of the output terminal Post clockwise until it is finger tight.
4. Place the supplied McIntosh wrench over the top of the output terminal and rotate it one quarter of a turn (90°) to secure the loudspeaker cable connection. **Do not over tighten.**

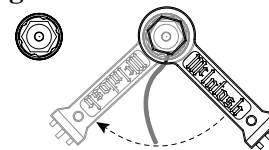

Connecting a Loudspeaker

The MHT300 is designed for loudspeakers with an impedance of 4 or 8 ohms. Connect a single loudspeaker only to one pair of the seven output terminals. Take note of how the speaker channels will be set up, as this will help facilitate any DIRAC/EQ settings established later on. Please follow the floor plans shown on page 26 when connecting specific channels to certain loudspeakers similar to your existing floor plan.

The seven pre-configured speaker channels come with jumpers connecting each channel to the preamplifier section. These jumpers can be removed to further integrate the seven power amplifier channels or the preamplifier channels into other multi-channel equipment.

When connecting loudspeakers to the MHT300 it is very important to use cables of adequate size so there is little to no power loss in the cables. The size is specified in AWG (American Wire Gauge). The smaller the gauge number, the larger the wire size.

Loudspeaker Cable Wire Gauge Guide			
Loudspeaker Impedance	Cable Distance		
	25 feet (7.62 meters) or less	50 feet (15.24 meters) or less	100 feet (30.48 meters) or less
4 ohms	14AWG	12AWG	10AWG
8 ohms	16AWG	14AWG	12AWG

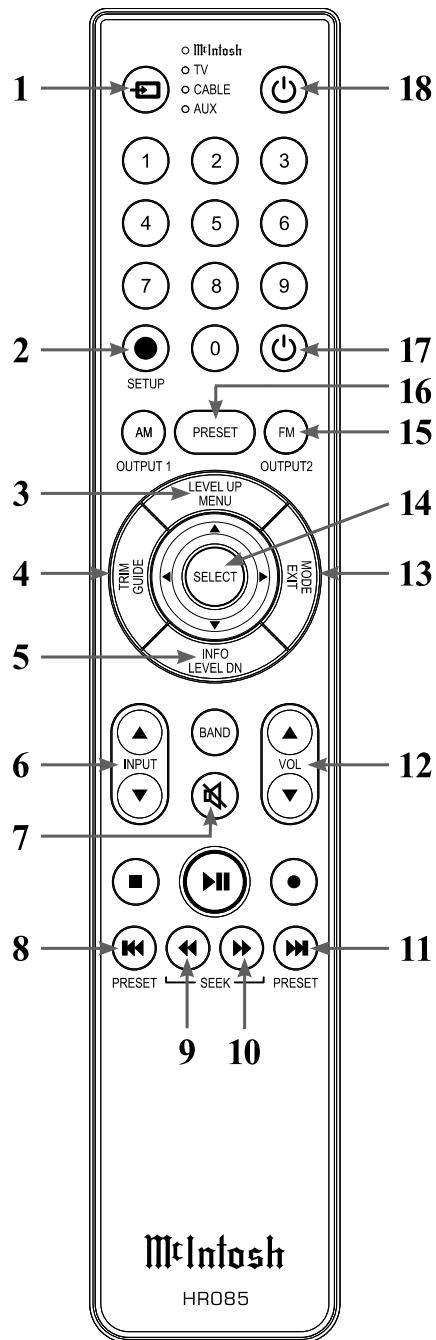

Navigating the Remote Control

- 1. Switch Device:** Select different devices for remote operation. Selected device is indicated by the LED light.
- 2. Setup Button:** Used to enter setup mode.
- 3. Level Up/Menu:** Adjusts trim functions settings. Accesses menu on compatible devices.
- 4. Trim/Guide:** Enters trim functions menu. Opens guide on compatible devices.
- 5. Info/Level Down:** Adjusts trim functions settings. Accesses info on compatible devices.
- 6. Input:** Changes and selects different inputs.
- 7. Mute:** Mutes audio playback.
- 8. Previous/Previous Preset:** Return to your previous media selection or a previous tuner preset.
- 9. Fast Reverse/Seek Down:** Navigate backwards through the current active media using this button. This is also used to adjust the tuner downwards.
- 10. Fast Forward/Seek Up:** Navigate forward through the current active media using this button. This is also used to adjust the tuner upwards.
- 11. Next/Next Preset:** Jump to your next media selection or navigate to the next tuner preset.
- 12. Volume:** Used to adjust the volume.
- 13. Mode/Exit:** This will exit the trim functions menu. It will also display information or certain options.
- 14. Select:** Selects the highlighted option.
- 15. FM/Output 2:** Access the FM tuner.
- 16. Preset:** Press this button to store current station onto the next available preset.
- 17. Power Off:** Turns off the selected device shown by the LED.
- 18. Power On:** Turns on the selected device shown by the LED.

Note: The HR085 Remote Control has buttons used to control multiple devices. Buttons whose function are not described are for use with other McIntosh products. For more information, refer to the HR085 Owner's Manual on the McIntosh website at www.mcintoshlabs.com.

How to use the Remote Control

Manual Tuning

Press the directional up▲ or down▼ buttons on the inner ring of the remote to navigate incrementally through stations.

Automatic Tuning

Press the SEEK **9** down or **10** up to move to the next station.

Preset Tuning

Press the PRESET **8** down or **11** up button and the MHT300 will stop on the next Station in preset memory.

Note: For information on entering a station into memory, refer to "Presets Edit" on page 28.

Setting a Preset

Once the FM station has been tuned, press the PRESET button **16** to store this station into memory.

Erasing a Preset

Tune in the station preset and press the PRESET button **16** to erase from memory.

Remote Control Batteries

The HR085 Remote Control included with the MHT300 is powered by two AAA batteries. To insert or remove batteries, open the battery compartment by removing the cover located on the back of the remote control. To open, pull the clasp located just above the opening downward.

Additional Discrete Commands

Additional discrete commands for external control systems are available:

- OPT1
- OPT2
- COAX1
- COAX2
- TUNER
- HDMI1
- HDMI2
- HDMI3
- HDMI4
- HDMITV
- Power (Cycle)

These additional commands can be accessed using an optional McIntosh HR093 Service Remote Control. A list of these commands as well as Pronto Hex Codes can be found in the MHT300 Pronto Hex Codes document located in the Download section of the MHT300 product information at www.mcintoshlabs.com

You can also contact McIntosh Technical Assistance or your dealer for more information.



Trim Menu

The trim menu allows you to make and store adjustments to various settings for all inputs. The trim menu can be entered using the INPUT knob or the remote control.

The following table lists the trim options and the range of values that can be adjusted:

Setting	Values
Bass	-12dB to +12dB in 1 dB increments
Treble	-12dB to +12dB in 1 dB increments
Dirac Live	On or Off
Voicing EQ	Select to apply to current input
Audio Delay (Lip Sync)	0 to 500 ms in 25 ms increments
Trim Center	-10dB to +10dB in 1 dB increments
Trim Surrounds	-10dB to +10dB in 1 dB increments
Trim Heights	-10dB to +10dB in 1 dB increments
Trim Subwoofer	-10dB to +10dB in 1 dB increments
Meter Lights	On or Off
Display Brightness	Max, 75%, 50%, or 25%
Tuner Mode	Frequency, Preset
Input Mode	Auto, Movie, Music, Game, Through

Trim Menu Using the Remote Control

- Enter the trim menu by pressing the TRIM button.
- You can scroll through the trim options by pressing the up or down arrows on the silver ring.
- Use the left and right arrows on the silver ring to change values for the selected trim option.
- Use the EXIT button to exit the trim menu or wait ten seconds for the menu to close automatically.

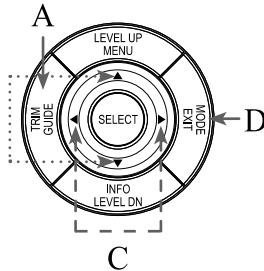

Trim Menu Using Knobs

To enter the trim menu, press and release the INPUT knob. (Holding the knob for two seconds enters the setup menu instead of the trim menu.)

Scroll through the options by turning the INPUT knob.

Change the values of the current option by rotating the VOLUME knob. Turn the INPUT knob to select another option to edit or press the INPUT knob and release to exit the menu. Changes will be saved.

Saving Trim Settings

Most trim settings are saved per input. For these settings, changes to one input will not affect another input. The following trim inputs are saved by individual input:

- Bass
- Treble
- Audio Delay
- Trim Center
- Trim Surrounds
- Trim Subwoofer
- Mode
- Voicing EQ

Some trim settings are saved Globally. Making a change to these settings for any input will make the same change for **all inputs**. Global trim settings are:

- Dirac Live EQ
- Meter Lights
- Display Brightness

Input Mode

The following input modes are available:

- AUTO
- THROUGH
- MOVIE

- MUSIC
- GAME

MOVIE, MUSIC and GAME are variables that are assigned a specific surround mode choice. The surround modes that are used for MOVIE, MUSIC and GAME options are assigned in setup. The default for each option is AUTO. Other options are Dolby Surround, DTS Neural:X, Multi-Channel Stereo, Stereo and Through. For more information about these options see “Setup: Audio > surround mode” on page 18.

A quick way to change the current input’s surround mode is to use the MODE button on the outer ring of the remote control. Pressing the MODE button will cycle through the surround modes. Stop on your choice. The display will time-out in a few seconds and your choice will be saved.

Assigning Input Modes

- Enter the trim menu by pressing the INPUT knob or the TRIM button on the remote control.
- Rotate the INPUT knob or press the down arrow on the remote control until MODE is displayed on the VFD.
- Press and release the INPUT knob or the SELECT button on the remote control.
- Rotate the INPUT knob or the up and down arrows on the remote control until the desired input is displayed.
- Rotate the VOLUME knob or press the left and right arrows to scroll through the surround modes.
- Press and hold the INPUT knob for two seconds or press the EXIT button to leave the trim menu (or wait until it times out).

Voicing EQ

Apply additional voicing preferences to current input. The general voicing curves are added to the Dirac Live Room EQ (if implemented) or existing settings (if Dirac Live not implemented). Custom Voicing EQ is not available if Dirac Live has not been implemented.

Voicing EQ select sets an easy tonal adjustment to enhance playback enjoyment. The selection is set to the current input, and remains active with that input only until changed. The available Voicing EQ filters are shown on the right.

Relaxed - Attenuates frequencies near 3kHz and boosts frequencies near 150Hz

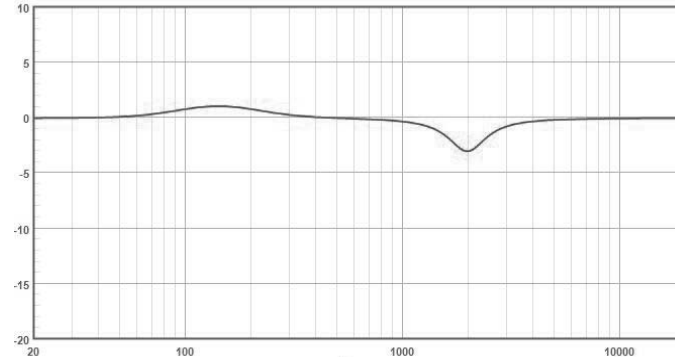

Music II – Slightly attenuates high frequencies, especially near 3 kHz.



Tilt – Attenuates high frequencies and slightly boosts very low frequencies.

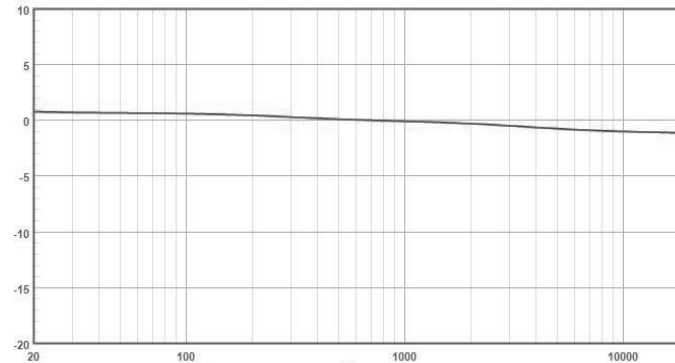

Action – Greatly accentuates low frequencies.

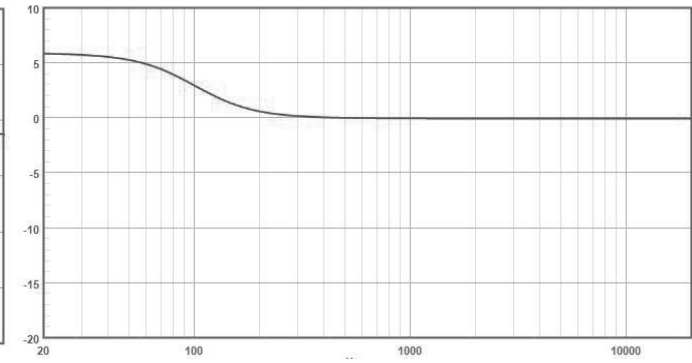

Music – Attenuates frequencies near 3 kHz.

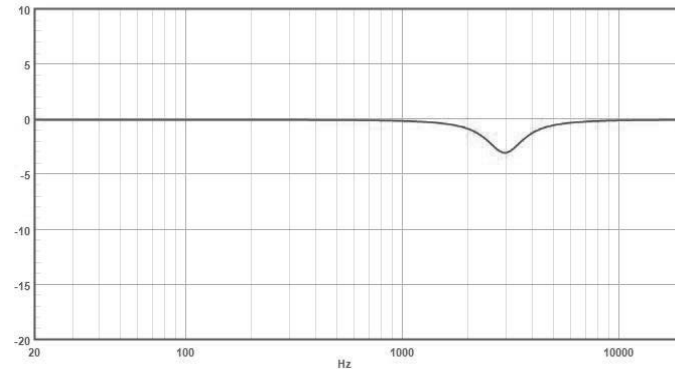

Action + Movie – Boosts low frequencies and attenuates very high frequencies.

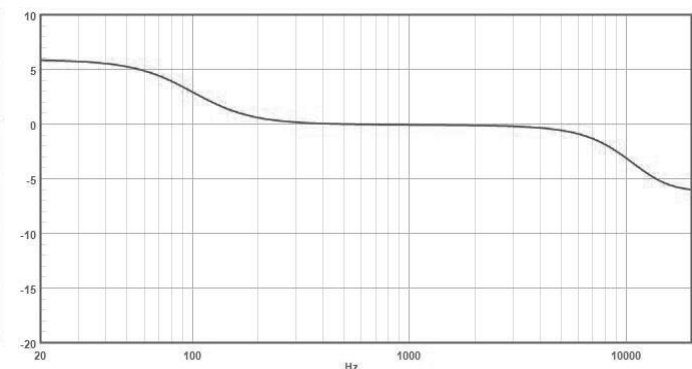



Setup Menu

Changing Settings

There are two ways to change the settings of the MHT300.

1. Use the front panel and the Vacuum Fluorescent Display (VFD) and the INPUT and VOLUME knobs or the remote control
2. Using a browser on a connected computer

Most will find it easier to navigate and enter information on a computer. If you don't have a connected computer or the MHT300 is not connected to your network, then using the front panel method can accomplish almost all the same things using some additional patience.

In this manual, submenus are denoted in the style:

SETUP: VIDEO > HDMI

The title above indicates from the setup menu choose the video submenu and then HDMI.

Navigating Setup with the Front Panel

To enter setup mode using the front panel press and hold the INPUT knob for two seconds and then release. A shorter push of the INPUT knob will bring up trim settings. See “Setting Up Surround Sound” on page 26.

Select options using a brief press of the INPUT knob. A long press of the INPUT knob will close the setup menu.

To return to a previous menu, scroll down to last menu choice which will be MENU BACK. On the top most menu, the last menu choice will be MENU OFF which will exit setup.

The setup menu will time out after 30 seconds of no user input.

Navigating Setup with the Remote Control

- A. Enter the setup menu by pressing the SETUP button with the blue circle.
- B. Use the up and down arrows on the silver ring to navigate through the options.
- C. Push the SELECT button to choose an option to change.
- D. Use the left and right arrows on the silver ring to change values for the selected setup option. The new value will be saved automatically.
- E. To stop editing a setting or to close the setup menu, press the Mode/Exit button or select the last option which is MENU BACK or MENU OFF.

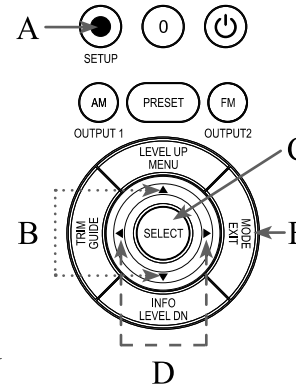

Setup from a Browser

Setup is easier from a web browser. Open a browser window on a computer connected to the same network as your MHT300. Enter the IP address for the MHT300 in the address bar of your browser (see “Setup: network > network Information” on page 21).

The setup menu on your browser should look like this:

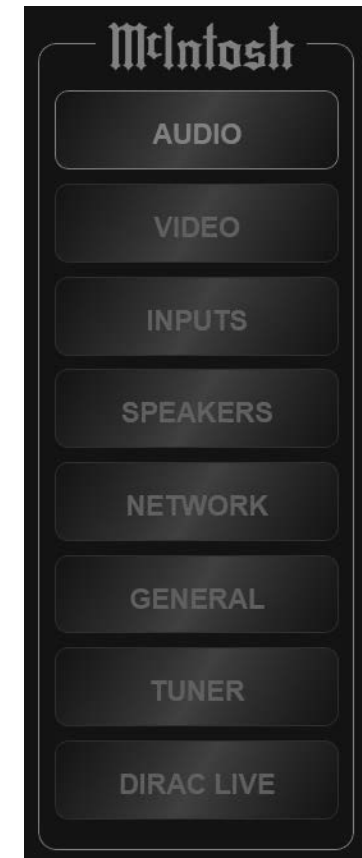

Setup Menu Options

- Serial Number
- Firmware Version
- Inputs
- Network
- General
- Audio
- Video
- Speakers
- Tuner
- Menu Off

Inputs Setup Menu

SETUP: INPUTS > HIDE SOURCES

The show/hide sources submenu allows you to hide unused inputs. Hidden inputs do not appear as input choices when scrolling through inputs. If you hid inputs and want to show them again, they can be restored by selecting “Show” on each or by choosing “Show all” from your browser to make all inputs visible.

SETUP: INPUTS > INPUT LEVEL

The input adjust section of the inputs menu allows you to set a trim level for a source.

The Trim for each input can be individually set from -12dB to +12dB in 1dB intervals. 0dB is the default. If using the browser you can type in your desired level in the box on the right.

Setting	Input	Options
Hide Sources Show/Hide*	HDMI 1 HDMI 2 HDMI 3 HDMI 4 HDMI TV OPT 1 OPT 2 COAX 1 COAX 2 TUNER*	Show, Hide, or Show All*
Input Level Input Adjust*	HDMI 1 HDMI 2 HDMI 3 HDMI 4 HDMI TV OPT 1 OPT 2 COAX 1 COAX 2 TUNER	-12.0 to +12.0dB in 1dB intervals
Rename*	HDMI 1 HDMI 2 HDMI 3 HDMI 4 HDMI TV OPT 1 OPT 2 COAX 1 COAX 2 TUNER	TV AUDIO CBL/SAT DVD Blue-Ray CD Media Player Game AUX 1-4 Default Custom

*Note: Some options and settings are only available on the browser version of the setup menu these are indicated with an *.*

Inputs Setup Menu from Browser

Accessing the inputs setup menu from the browser allows you to customize the name of an input as it will appear on the display. Unused inputs can also be hidden so as not to appear as choices. They can also be easily restored when needed.

Renaming Inputs

To change the name of an input, choose one of the default options from the drop-down menu or select Custom and type your name of choice into the Custom Rename box and press Enter to save.

Note: Custom names have an 11 character limit and will not save if you type more than 11 characters.

From the Rename submenu, you can choose from a list of names for the input or chose “default” to keep the original MHT300 input name or if you wish to use a custom name.

To use a custom name:

- Select “Custom” in the Rename submenu
- In the Custom Rename box, erase the old name and type in the new name up to 11 characters
- Push the Enter key on your keyboard to save



General Setup Menu

The general menu contains the following options:

Setting	Options
Firmware Version	Shows current firmware versions
Firmware Update	Yes, No
Factory Reset	Yes, No
Save and Load	Save, Load
Trigger 1	All, None, Independent
Trigger 2	All, None, Independent
RCLOCK	On, Off
Auto Off	On, Off

SETUP: GENERAL > FIRMWARE

Firmware is software that controls hardware at a low level. Occasionally, new versions of firmware may be issued to address particular issues. If you are not experiencing any issues, there is no need to upgrade your MHT300 firmware. If the need should arise, your McIntosh dealer has access to the latest firmware.

Firmware Update is used to install new firmware. The new firmware should be unzipped on the root directory of a properly formatted USB drive (FAT or Fat32). The USB drive should be inserted into the USB port on the rear of the MHT300. Selecting the Update Now button will begin the process. It is highly recommended that your McIntosh dealer perform the update process since failure to properly install the firmware can leave the MHT300 in an unusable state.

SETUP: GENERAL > FACTORY RESET

Factory Reset will restore the MHT300's defaults. Any changes made will be lost. Configurations can be saved and restored in the "Save and Load" section of the general setup menu.

SETUP: GENERAL > SAVE AND LOAD > SAVE

MHT300's Dirac Live information is saved with configuration backups. Dirac Live should be re-run anytime a significant change is made in your system or its environment.

To save the configuration using the browser interface, select the save configuration button. Choose the destination to store the file. A file named "MHT300_config.cfgs" will be created. If you choose, you can rename this file and save different setup configurations.

Note: Configurations created using the browser interface must be restored using this interface and CANNOT be restored using the MHT300's front panel interface or MHT300's USB port.

If you wish to store to a USB drive in the MHT300's USB port, you must use the front panel interface.

To use the front panel interface to save the configuration:

- Insert a USB Drive in the MHT300 USB port
- Go to the Save and Load submenu, and select Save

Two files are created when using the front panel to save to a USB drive in the rear of the MHT300:

- DIRAC INFO
- MHT300.CFG which contains the custom MHT300 settings

SETUP: GENERAL > SAVE AND LOAD > LOAD

To load a saved configuration, select the load configuration button. Choose saved configuration file from its location either from a folder on your computer or a USB drive inserted into the computer's USB port. Configuration files by default are named "MHT300_config.cfgs". Choose this file or a file you have custom named. Select open. The interface will say "Upload Complete" and the MHT300 will power cycle and the new settings will be loaded.

If you are using the front panel to load a configuration:

- Insert the USB Drive with the configuration file stored in the root directory in the MHT300 USB port.
- Go to the Save and Load submenu and select Load. Progress will be displayed for loading the two configuration files.
- The MHT300 will power cycle when complete. The restored settings will be in effect.

General Setup Menu (continued)

SETUP: GENERAL > TRIGGER

Trigger1 and Trigger2 can each be set to power on/off components connected via a power control cable (see “Power Control Connectors” on page 8).

Each Trigger can be set to:

- Independent allows each individual input to be set to On or Off. When an input that is set to On is selected, connected components will receive a power control signal to power on until the selected input is changed (to an input that is set to Off) or the MHT300 is powered Off.
- All On sets the power control setting of all inputs to On. With this selection, any input will generate a power control signal to be sent for that Trigger. All On is a quick way to change all the inputs to On. You can switch to Independent to set any individual input to Off.
- All Off sets the power control setting of all inputs to Off. With this selection, no input will generate an On signal for the Trigger. All Off is a quick way to change all the inputs to Off. You can switch to Independent to set any individual input to On.

When Independent is selected, you can select On or Off for these inputs:

- | | |
|-----------|-------------|
| • HDMI 1 | • Optical 1 |
| • HDMI 2 | • Optical 2 |
| • HDMI 3 | • Coaxial 1 |
| • HDMI 4 | • Coaxial 2 |
| • HDMI TV | • Tuner |

SETUP: GENERAL > FIRMWARE

Auto Off, when Enabled, the MHT300 will power off after 30 minutes of no input. If you pause a movie for more than 30 minutes and you do not want to find the MHT300 powered off, you would want to Disable Auto Off.

SETUP: GENERAL > RCLOCK

Remote Control lock when enabled (On) will prevent the front IR sensor from receiving IR commands from a remote control. The default for remote control lock is Off. To enable the IR sensor to detect a remote control’s IR data, set remote control lock to OFF (the default).

SETUP: GENERAL > AUTO OFF

The MHT300 incorporates power save circuitry to automatically place the MHT300 into the power saving standby mode approximately 30 minutes after there has been an absence of an audio input signal on both channels.

When there is a power control connection between the MHT300 and a preamplifier or source component, the auto off function is bypassed.



Audio Setup Menu

The audio setup menu contains the following options:

Setting	Options
Sub Level	-10.0 through +10.0
Bass Sync	0-16ms
Audio Delay (Lip Sync)	0-500ms
Volume	Scale, Limit
Surround Mode	Music, Movie, Game
Dynamic Range Compress*	ON, AUTO, OFF

*Note: Some options and settings are only available on the browser version of the setup menu these are indicated with an *.*

SETUP: AUDIO > SUB LEVEL

Subwoofer level adjust allows for adjusting your attached subwoofer to be adjusted from -10dB to +10dB.

SETUP: AUDIO > BASS SYNC

For contents recorded in multi-channel such as Blu-ray discs, the recorded Low Frequency Effects (LFE) may be out of sync and delayed. This function allows you to correct the delay with an adjustment of 0 ms to 16 ms.

SETUP: AUDIO > AUDIO DELAY

Audio delay (Lip Sync) compensates for incorrect timing between video and audio. When auto lip sync is set to On, the timing difference will be automatically corrected with compatible TVs. The adjust option allows you to manually adjust the delay correction from the default of 0 ms up to 500 ms.

Volume Submenu Options

Setting	Options
Scale	Linear, dB Level
Limit	OFF, 60, 70, 80

SETUP: AUDIO > VOLUME > SCALE

There are two choices for how to display the volume. The default is a volume scale linear which displays the volume on a scale of 0 (mute) to 99. The second option is volume scale dB level. This will express the volume as decibel (dB) level. The decibel scale is from -103.0dB (mute) to 18dB.

Note: The displayed dB scale increments are not uniform as they have been designed to give a meaningful level adjustment depending on the actual level being listened to.

You can change the volume level of the MHT300 using the slider. Slide towards the right to increase and to the left to decrease the volume level. The current volume percentage for the linear scale or dB for the dB scale will appear in the box to the right.

SETUP: AUDIO > VOLUME > LIMIT

Volume limit can protect equipment and/or ears from unintended extreme volume by setting an upper threshold for how high the volume level can be set. Volume limit can be set to Off (the default) or to one of these three volume limits:

- 60 (-1.5dB)
- 70 (3.5dB)
- 80 (8.5dB)

If volume limit is not Off, the MHT300's volume level can not be set above the selected volume limit.

SETUP: AUDIO > SURROUND MODE

Setting	Options
Music	Through, Auto, Dolby Surround, Neural: X, Multich Stereo, Stereo
Movie	Through, Auto, Dolby Surround, Neural: X, Multich Stereo, Stereo
Game	Through, Auto, Dolby Surround, Neural: X, Multich Stereo, Stereo

In the surround mode setup, you can assign a surround mode to each of three sound categories:

- Music
- Movie
- Game

These three sound categories can be assigned to an input using the trim menu, for more information refer to "Trim Menu" on page 12. Categories make it easier for someone unfamiliar with DTS or Dolby to select the proper surround mode by selecting Music, Movie, or Game which can be assigned to any of the following choices in setup:

- Through
- AUTO (default)
- Dolby Surround
- DTS Neural:X
- Multi-Channel Stereo
- Stereo

The surround mode represented by the Trim selections Music, Movie, and Game must be assigned in setup. If no assignment has been made, the default for each is Auto.

Audio Setup Menu (continued)

Auto will always send audio to all configured speakers no matter the input audio stream type. It will use Dolby Surround to send audio to all configured speakers if the incoming audio stream is Dolby encoded. It will use DTS Neural:X to send audio to all configured speakers if a DTS encoded audio stream comes in. If a 2 channel or multi-channel PCM stream comes in, it will use Dolby Surround to send audio to all configured speakers.

Dolby Surround will invoke Dolby's post processor to always send audio to every configured loudspeaker no matter the input stream type.

DTS Neural:X will invoke DTS' post processor to always send audio to every configured loudspeaker no matter the input stream type.

Multi-channel stereo will downmix and/or upmix to send audio to all left and right speakers (plus sub if configured) no matter the input stream type. This surround mode is similar to party mode in similar products. Use this setting to deliver audio to all channels.

Stereo will downmix to send audio to only the left and right front speakers (plus sub if configured) no matter the input stream type.

Through will neither upmix nor downmix. The input stream will be sent to the configured speakers per the input file stream with no post processing.

Audio Setup Menu from Browser

Dynamic Range Compress

Dynamic Range Compress has 3 options: OFF, ON, and Auto that apply to the HDMI inputs. Dynamic Range Compression allows reduced volume listening of video sound while retaining the ability to hear voices and reduced level sounds.

- OFF retains full dynamic range of the original signal content.
- AUTO applies a medium level of compression that may be more enjoyable under overall listening conditions.
- ON applies maximum compression for difficult listening conditions.



Video Setup Menu

The video setup menu has the following options:

Setting	Input
HDMI Setup	Submenu described below
ON SCREEN DISP	OFF, BOTTOM, TOP
TV Audio Switching*	ON, OFF
Power Off Control*	ALL, VIDEO, OFF
Power Saving*	ON, OFF

*Note: Some options and settings are only available on the browser version of the setup menu these are indicated with an *.*

SETUP: VIDEO > HDMI SETUP

The Video setup menu has one main submenu for HDMI settings, the options for it are shown below.

Setting	Input
PASSTHRU	NONE, HDMI 1-4
ARC	ON, OFF
CEC	ON, OFF

SETUP: VIDEO > HDMI SETUP > PASS THRU

Pass through (written as HDMI PASSTHRU on the front display) allows an HDMI input to be assigned so that when a signal is received by that HDMI input, while in standby mode, the MHT300 will pass the complete signal to the HDMI output exactly as it was received for video and audio playback by a connected TV or monitor.

Note: CEC should be disabled if you plan to use the pass through feature to avoid your TV turning on your MHT300 and other unexpected results.

SETUP: VIDEO > ON SCREEN DISP

On screen display, when On, will display the volume on an attached TV when the volume is activated. Off will disable this feature.

Bottom and Top refer to the position on the TV where the volume will be displayed. Both Bottom and Top enable (on) the on screen display feature.

SETUP: VIDEO > HDMI SETUP > ARC

The ARC (Audio Return Channel) feature, when enabled, will work with the TV Audio input and a television connected to the HDMI OUT/ARC output on the back of the MHT300.

ARC can provide two-way communication between units allowing for volume control and lip-syncing functions to ensure audio and video are perfectly matched. This allows for more intelligent operation between components as well as less cable clutter. Make sure the ARC is enabled in your TV's setup menu as well as on the MHT300.

SETUP: VIDEO > HDMI SETUP > CEC

CEC (Consumer Electronics Control) is an addition to the HDMI standard which allows control signals from one device to communicate with another device via an HDMI cable connection. If you change HDMI control settings, reset power to connected devices. Make sure CEC is enabled on all devices you wish to utilize CEC.

Notes: 1. To use ARC, CEC must also be set to On.

2. To use CEC and the additional commands of TV audio switching, power off control and power saving, CEC must be set to on, so your television and MHT300 can better communicate.

The world of ARC and CEC is not yet perfect. It is certainly getting better, but not every component in the world is speaking precisely the same language. There may be circumstances where you may have better performances by turning these features off. These features can be enabled or disabled at any time on the MHT300.

Remember to enable CEC on your television if you want to use CEC with the MHT300.

CEC should be set to Off, if you are using a third-party control system so that CEC does not compete with your external controller.

Video Setup Menu from Browser

TV audio switching, power off control and power saving are only available options if CEC is turned on and are only accessible through the browser interface of the setup menu.

TV Audio Switching

TV audio switching, when set to ON, will switch to TV audio when receiving a command from the TV.

When set to OFF, the MHT300 will not automatically switch to TV audio when receiving a command from the TV.

Power Off Control

Power off control, when set to ALL, the MHT300 will enter sleep mode when the TV is turned off regardless of input. When power off control is set to VIDEO, the MHT300 will enter sleep mode when the TV is turned off and the MHT300's input is set to an HDMI input. When set to OFF, the TV's power will not effect the MHT300's standby mode.

Power Saving

Power saving, when to ON, will put the MHT300 in sleep mode if the audio source is TV and the TV's audio output is set as the TV's speaker. Power saving will apply when the MHT300 is using an HDMI input.

Network Setup Menu

SETUP: NETWORK

Setting	Options
Network Information	Connection Status Host IP Address Host Mac Address Dirac IP Address
Network Identify	OK
Network Control	On, Off
Friendly Name	MHT300, Home Theater, Living Room, Family Room, Guest Room, Dining Room, Master Bedroom, Bedroom, Den, Office, None, Custom*

*Note: Some options and settings are only available on the browser version of the setup menu these are indicated with an *.*

SETUP: NETWORK > NETWORK INFORMATION

- Connection status will show whether the device is Connected or Not Connected to the internet.
- Host IP address will display the MHT300's IP address.
- Host Mac address will display the MHT300's Mac address.
- Dirac IP Address will display the specific IP Address for the MHT300's Dirac function.

SETUP: NETWORK > NETWORK CONTROL

Network control has two settings: On or Off. The default is Off. When network control is enabled (On), a control system such as one using RS232 commands over IP can awaken the MHT300 from a sleep state. When network control is off, the MHT300 will enter standby mode when powered off. The monitoring of network traffic with network control On uses slightly more power when the MHT300 is in sleep mode.

SETUP: NETWORK > FRIENDLY NAME

Friendly name provides a more individual way of identifying your MHT300 on the network with devices that recognize friendly names.

The default friendly name of "MHT300" can be changed by selecting an alternative name from the preset name drop-down list. To create your own name for the MHT300, choose "Custom" from the preset name drop-down box and then type the new name in the friendly name box. Custom names can only be entered from the browser interface. Preset names can be chosen using the front panel or your remote control.

Network Settings

Network settings allows you manually entering network information. You may do this if you want to have a static IP address for the MHT300. The default is for DHCP is On. With DHCP on, all the network information will be assigned automatically from your router.

To manually enter network settings, select "Off" for DHCP. This will allow you to enter settings for:

- IP address
- Gateway (typically the IP address of your router)
- Subnet mask (typically 255.255.255.0)
- DNS address (typically the IP address of your router)

When you have completed making network settings changes, select the "Apply All Settings" button to save your changes.



Speakers Setup Menu

The speakers setup menu contains the following submenus:

- Amp Assign
- Speaker Configuration
- Speaker Distances
- Speaker Level
- Crossover

SETUP: SPEAKERS > AMP ASSIGN

Setting	Options
Manual Floor	2 channel, 5 channel, 5 channel + SB
Manual Top SP Top Speaker	None, 2 channel, 4 channel*
Top Layout	Front, Middle, Rear, Front + Rear*, Front + Middle*, Middle + Rear*
Manual Dolby	None, 2 channel, 4 channel*
Dolby Layout	Front, Surround*, Rear*, Front + Rear*, Front + Middle*, Middle + Rear*

Note: 1. Some settings are only available on the browser version of the setup menu these are indicated with an *.
2. Choosing some options will eliminate others.

In amp assign, you select how to use the preamplifier section of the MHT300. In the amp assign section of setup, you can tell the MHT300 what speaker setup scheme you will be using. This assignment is necessary before running Dirac Live.

SETUP: SPEAKERS > SPEAKER CONFIG

The available speaker categories are based on the settings in Amp Assign (see above).

Speaker	Options
Front	Large / Small
Center	Large / Small / None
Subwoofer (SUB)	1 speaker / 2 speaker / None
Surround (SUR)	Large / Small / None
Surround Back (SUR BK)	Large / Small
Front Height (FR HT)	Large / Small
Back Height (BK HT)	Large / Small
Top Front*	Large / Small
Top Rear*	Large / Small
Top Middle*	Large / Small

Note: 1. Some settings are only available on the browser version of the setup menu these are indicated with an *.
2. Choosing some options will eliminate other options.

Speakers are defined as Large or Small. A Large Speaker is a full-range speaker able to reproduce bass frequencies down to 35Hz within -3dB of the midrange frequencies. If it is not Large, then it is Small.

SETUP: SPEAKERS > SPEAKER DISTANCES

Setting	Options
Front Left	0.0 to 10.0m in 0.1m increments
Front Center	0.0 to 10.0m in 0.1m increments
Front Right	0.0 to 10.0m in 0.1m increments
Surround Right	0.0 to 10.0m in 0.1m increments
Rear Right	0.0 to 10.0m in 0.1m increments
Rear Left	0.0 to 10.0m in 0.1m increments
Surround Left	0.0 to 10.0m in 0.1m increments
Top Front Left*	0.0 to 10.0m in 0.1m increments
Top Front Right*	0.0 to 10.0m in 0.1m increments
Top Rear Left	0.0 to 10.0m in 0.1m increments
Top Rear Right	0.0 to 10.0m in 0.1m increments
Subwoofer 1	0.0 to 10.0m in 0.1m increments
Subwoofer 2	0.0 to 10.0m in 0.1m increments

Note: Some settings are only available on the browser version of the setup menu these are indicated with an *.

The input of distances of your speakers can be entered manually. Distances will be provided automatically when the Dirac Live setup program is run, after which they can be edited. Having an accurate accounting of your speaker speeds the Dirac Live process by avoiding Dirac Live looking for phantom speakers.

For each speaker, enter the distance from the main listening position to the speaker in meters. To convert feet to meters, multiply the number of feet by 0.3048.

The Dirac Live program will provide more exacting information. The information entered here provides a baseline to compare the Dirac Live findings.

For Dolby enabled speakers, enter the distance to the speaker. Do not calculate the angled path that the reflected sound will travel. Dirac Live will handle this.

SETUP: SPEAKERS > SPEAKER LEVEL

Setting	Options
Test Tone	On, Off
Front Left	-10 to +10dB in 1dB increments
Front Center	-10 to +10dB in 1dB increments
Front Right	-10 to +10dB in 1dB increments
Surround Right	-10 to +10dB in 1dB increments
Rear Right	-10 to +10dB in 1dB increments
Rear Left	-10 to +10dB in 1dB increments
Surround Left	-10 to +10dB in 1dB increments
Top Left Front*	-10 to +10dB in 1dB increments
Top Right Front*	-10 to +10dB in 1dB increments
Top Rear Left	-10 to +10dB in 1dB increments
Top Rear Right	-10 to +10dB in 1dB increments
Subwoofer 1	-10 to +10dB in 1dB increments
Subwoofer 2	-10 to +10dB in 1dB increments

*Note: Some settings are only available on the browser version of the setup menu these are indicated with an *.*

The test tones and levels submenu provides the ability to manually set relative levels for all speaker types, and may be used to confirm proper wiring. This does not need to be set if using Dirac Live calibration.

When test tone is set to On, a tone will play through the speaker type selected in the levels drop-down box. Using a sound meter or your ears, you can set the relative level from -10dB to +10dB. The default is 0dB.

Dirac Live will automatically set levels and will over-write offsets set previously. Likewise, manually setting test tones will replace Dirac Live settings.

SETUP: SPEAKERS > CROSSOVER

Setting	Options
Dependence	Independent, All
Cross All	40, 60, 80, 90, 100, 110, 120, 150, 200, 250 Hz
Independent	Front, Center, Surround (SUR), Surround Back (SUR BK), (BK HT)
Bass Type	LFE, LFE + MAIN
Bass LP Filter	40, 60, 80, 90, 100, 110, 120, 150, 200, 250 Hz

Sound below the crossover frequency is filtered from the output to “small” speakers and is sent to the subwoofer or front speakers. Most small speakers use a crossover frequency of 80Hz, but small speakers may need a crossover set as high as 250Hz. We recommend setting to a higher frequency when small speakers are used. For example, set to “250Hz” when the frequency range of the speakers is 250Hz to 20kHz.

You can choose Independent or All. Cross All will globally set the crossover frequency to the chosen value. Independent will allow each available speaker’s crossover frequency to be set using the same options as Cross All.

SETUP: SPEAKERS > CROSSOVER > BASS TYPE

When the subwoofer mode is set to LFE (Low Frequency Effects), the LFE channel plus the low frequency output below the set crossover frequency of speakers set to small is sent to the subwoofer

When set to LFE+Main, the LFE channel and low frequency output, below the set crossover frequency, of the main channel are sent to the subwoofer.

SETUP: SPEAKERS > CROSSOVER > BASS LP FILTER

The bass low pass filter sets an upper limit for frequencies that are sent to the subwoofers when LFE+Main is selected above. Frequencies above the chosen option will not be sent to the subwoofer. The LPF setting does not apply to content sent from the LFE channel to the subwoofers.

Speaker Placement

Speaker	Position
Front	The Front Left and Right speakers should be an equal distance from the main listening position. The distance between each speaker and your TV should also be about the same.
Center	The Middle speaker should be between the Front speakers and above or below your TV.
Top Front	Mount the Top Front Left and Right speakers on the ceiling slightly in front of your main listening position and align with the Left and Right Front speakers.
Top Middle	Mount the Top Middle Left and Right speakers directly above the main listening position and align with the Left and Right Front speakers.
Top Rear	Mount the Top Rear Left and Right speakers on the ceiling slightly behind your main listening position and align with the Left and Right Front speakers.
Subwoofer	Place the Subwoofer at a convenient location near the Front speakers. If you have two Subwoofers, place them asymmetrically across the front of your room.
Front Dolby speaker Left/Right	Place the Front Dolby Enabled speakers on the Front speakers (left and right). For a Dolby Atmos Enabled speaker integrated with a Front speaker, place the Dolby Atmos Enabled speaker instead of the Front speaker.
Surround Dolby speaker	Place the Surround Dolby Enabled speaker on the Surround speaker. For a Dolby Atmos Enabled speaker integrated with a Surround speaker, place the Dolby Atmos Enabled speaker instead of the Surround speaker.
Back Dolby speaker	Place the Back Dolby Enabled speaker on the surround back speaker. For a Dolby Atmos Enabled speaker integrated with a Surround Back speaker, place the Dolby Atmos Enabled speaker instead of the Surround Back speaker.

More information about speaker placement can be found in “Setting Up Surround Sound” on page 26.



Dirac Live® Setup

1. Complete amp assign to establish the room's layout using either the front panel or the browser setup menu. This will set up the MHT300 to know which proper channels to enable to deliver audio to ("Setup: Speakers > Amp Assign" on page 22)

Note: After completing "Amp Assign", press "Next", and finally press "Start." This refreshes NET connection to DIRAC within the MHT300. Please wait at least 30 seconds to connect to the MHT300 within the Dirac Live app.

2. Make the room as quiet as possible. Background noise can disrupt the room measurements. Close windows and turn off unnecessary electronic devices (radios, air conditioners, fluorescent lights, etc.).
3. Connect the included measurement microphone to the MHT300.
4. Create a DIRAC account and install the app from <https://www.dirac.com/live/downloads>

Select Device (MHT300)

5. Select recording device (microphone). An icon with a microphone should appear with a graph.
6. Click the graph to select proper calibration file
7. Select "Use from device."

Volume Calibration

8. Set the Master output to a low setting to avoid damage to ears or speakers.
9. Set the microphone gain to +0dB.
10. Use the Play Button to test channels individually to hear if their level is suitable. Slowly raise the master output level until sound can be heard.
 - Repeat this step for each speaker.
11. Once each channel is complete, adjust the Master output to a normal or slightly loud listening level.

Calibration notes:

- A common master volume range is -35dB to -25dB.
- A signal-to-noise ratio error indicates too low of audio to measure. Master output may need to increase.
- A clipping error indicates too high of an audio level to measure. Master output may need to decrease.
- If your subwoofer has gain control, this control may need to be adjusted to assist with the volume calibration of that channel.

Select Arrangement

12. Dirac offers different arrangement settings for measurements: Tightly Focused, Focused, and Wide Imaging.
13. Please choose one that matches closest to your own listening arrangement. A wider listening arrangement may require more measurement positions with the microphone

Measure

14. Place the microphone closest to the listening position shown in arrangement image.
15. Press "Measure selected position."
16. DIRAC will now send test tones out of the system's channels to measure.

Note: While measuring a 7.2.4 system, the test tone will appear to come from both subwoofers together. This is normal.

17. When measurement is finished, Dirac will automatically go to the next position to be measured.
18. Relocate the Microphone to match the next position shown in DIRAC for the next measurement.
19. Repeat the "Measure selected position" for each position in Dirac's arrangement Image.

Note: Please take the time to SAVE your current project at this point, as it will allow you to open this measurement and edit your filter in the future without having to remeasure your arrangement again.

Filter Design

20. Dirac Live will automatically generate a suggested target curve based on your speakers' performance and tune their response to meet the suggested curve. These curves can be adjusted to your preferences.
21. To manually adjust the generated curve, follow the Dirac Live User Manual on Filter Design: <https://confluence.dirac.services/x/FImCCQ>

Filter Export

22. Once the desired filter is achieved, the filter may now be exported and saved onto the MHT300.
23. Dirac will give the opportunity to name and describe the filter.
 - The MHT300 can store up to 4 exported filters.

The Dirac Live process is now complete, and Dirac may be enabled or disabled with available filter selections via the trim menu and browser.

Future Filter Edits:

Amp Assignment must be set to the same settings as when the project was measured with to be able to open a specific project and speaker arrangement. For example, if a Dirac Live measurement was taken with system set to 5.1 – if amp assign is changed to 5.0: the project measured with 5.1 will not be able to open until the MHT300 is set back to 5.1.

For further Support with Dirac go to: <https://confluence.dirac.services/display/DLS/Dirac+Live+Support>



Setting Up Surround Sound

Setting up speakers for a surround setup takes planning, measuring and installation. Depending on your level of expertise and available time, you may wish to employ the services of your McIntosh dealer for expert setup of your system. Professional installation of in-ceiling speakers is particularly important due to gravity and the location above your head.

The number, types and locations of speakers are key elements in setting up the system. There is a multitude of possible configurations, and the MHT300 is very flexible in its setup to adapt to many of these configurations.

Often surround setups are referred to by numbers for example 7.2.4. The first number refers to the number of traditional “floor” speakers (front, center and surround). The second number is the number of subwoofers that can be connected, and the third number refers to the number of in-ceiling or upward firing speakers in the setup.

The type of speaker (size and location) will be entered later during Speaker setup. The distance of the speaker from the listening location is manually entered in the Speaker setup, or automatically entered during the Dirac Live® calibration process.

At this stage, the connection from the MHT300 to the various speakers, powered subwoofers, and auxiliary amplifiers should be made with high quality cables as necessary.

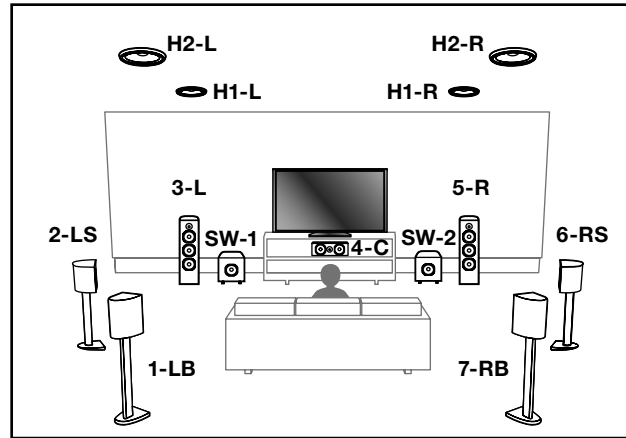

7.2.4 with Front & Rear Tops

The ideal setup for the MHT300 is shown above. It features two subwoofers, seven floor speakers, and four ceiling mounted speakers. The settings from the browser setup menu are shown below.

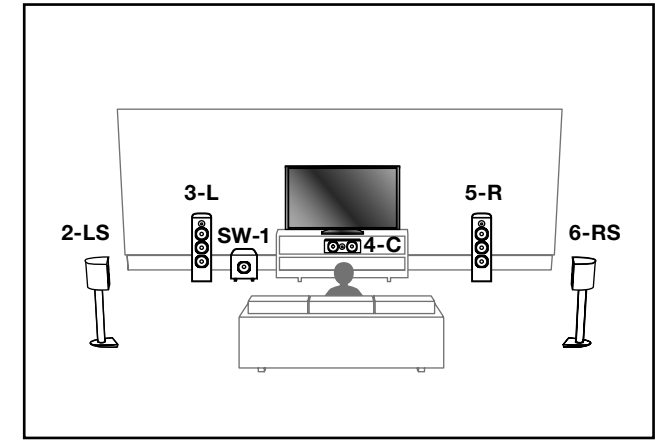
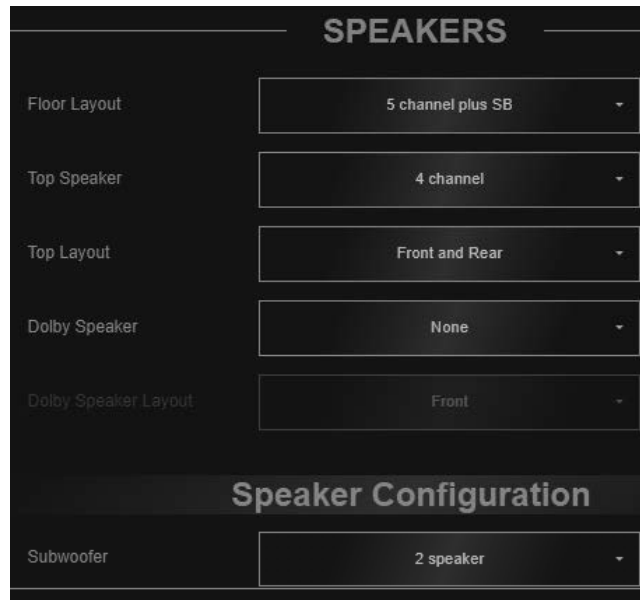

5.1

Another common setup for the MHT300 is shown above. It features one subwoofer and 5 floor speakers. The settings from the browser setup menu are shown below.

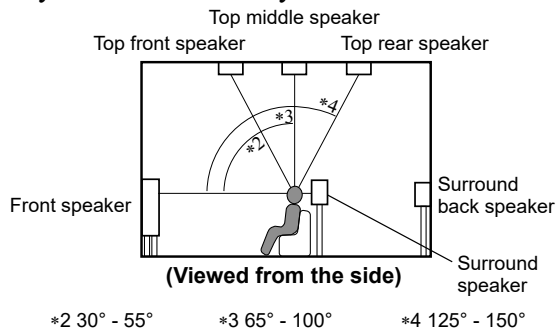
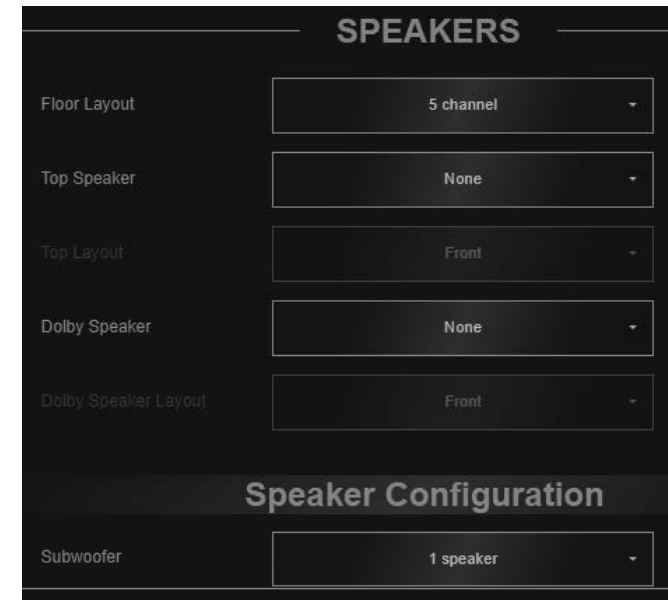

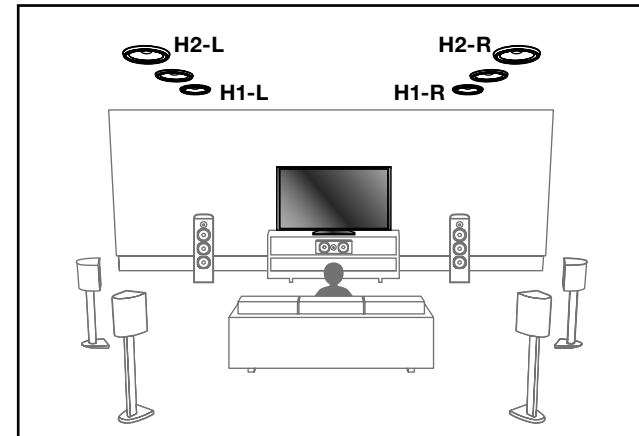
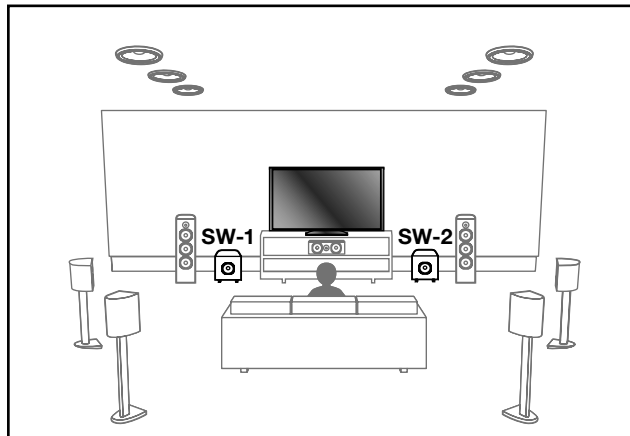
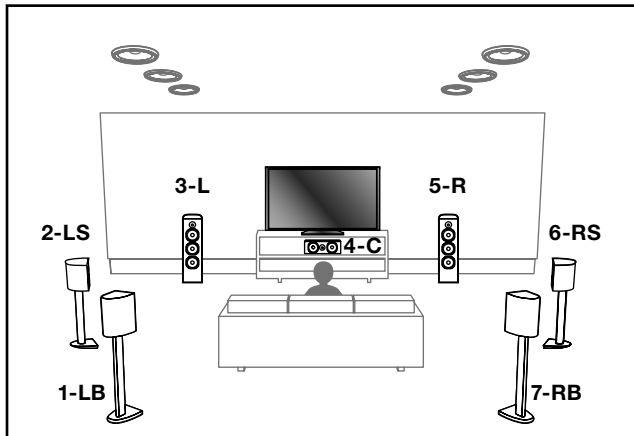

Speakers

The MHT300 has seven speaker outputs to connect to speakers around the room.

Subwoofers

Your surround sound setup might include one or two subwoofers. Use the SW1 and SW2 outputs on the back of the MHT300 to connect them.

Heights

The MHT300 has four height outputs that can be connected to a secondary amplifier(s) to drive up to four locations on the ceiling or can be configured for up to four Dolby Atmos speakers. Dolby Atmos Enabled speakers reflect the sound off the ceiling to allow the sound to come from over your head by using a special upward-pointing speaker that is placed on the floor.

Note: HR1 and HL1 should be forward of HR2 and HL2.

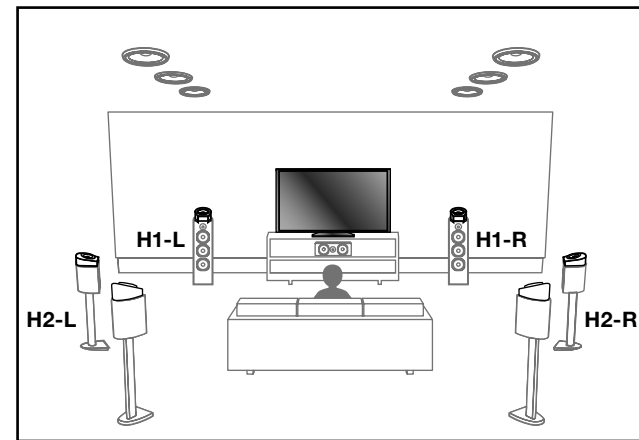
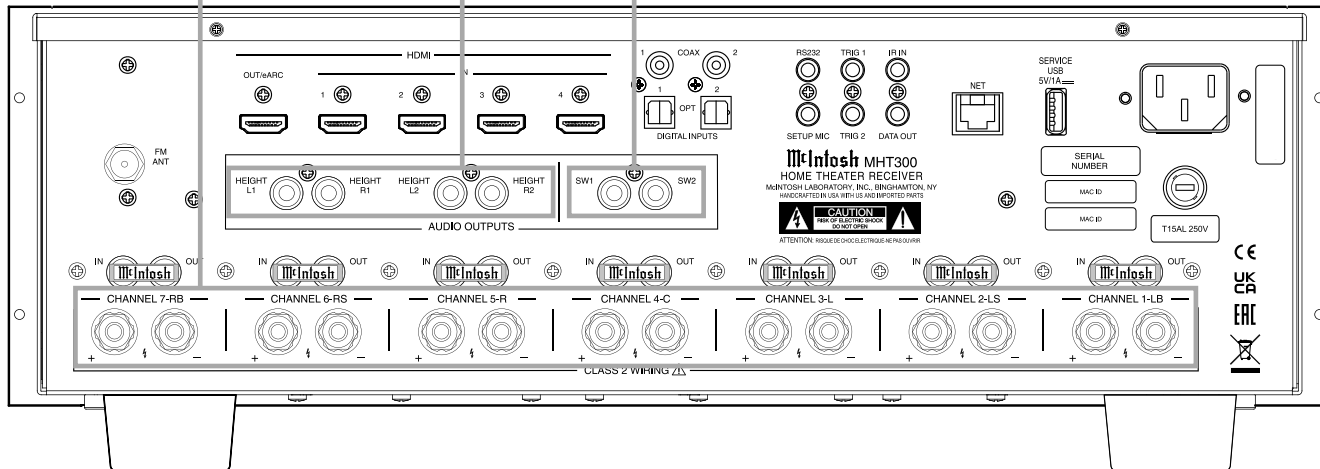
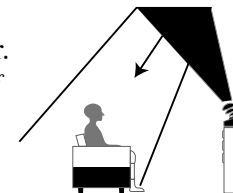



Tuner Setup Menu

SETUP: TUNER

Setting	Options
Tuning	Frequency, Preset
Region	North America, Japan, Europe 50kHz, Europe 100kHz
Reset Presets	Yes, No
Presets Edit	Erase?

Note: Some options and settings are only available on the browser version of the setup menu these are discussed in “Tuner Setup Menu from Browser” on page 28

SETUP: TUNER > TUNING

Change this setting between Frequency and Preset to dictate tuning type using the INPUT knob. Frequency will result in the INPUT knob tuning stations incrementally, while Preset will result in tuning only between stations stored in preset memory. See “Navigating the Tuner Input” on page 29 for more information.

SETUP: TUNER > TUNER REGION

In some countries, broadcasters use slightly different standards and the MHT300 accommodates these differences. Your McIntosh MHT300 has been factory configured for the broadcast standards in your country. If for some reason there is a need to make a change, follow the steps below for changing the receiving standards:

Note: Accessing/Changing the current tuner region will result in clearing of all the stored station presets.

1. Press the INPUT knob until the setup mode is active. Then rotate the INPUT knob to select setup menu item “SETUP: MENU TUNER” by pressing INPUT knob. Rotate the INPUT knob to select REGION.
2. Rotate the VOLUME knob to highlight one of the four choices and press the INPUT knob to select the desired region.

Setting	FM Band
USA	88.1MHz - 107.9MHz
JAPAN	76MHz - 108MHz
EUR 100	87.5MHz - 108MHz
EUR 50	87.5MHz - 108MHz

SETUP: TUNER > RESET PRESETS

To erase all stored presets, use the INPUT knob to enter the RESET PRESETS Menu. Then use the VOLUME knob to select either “NO” or “YES” to reset all presets.

SETUP: TUNER > PRESETS EDIT

To erase individual preset stations, use the INPUT control to enter the PRESETS EDIT menu. Continue to use the INPUT control to rotate and select the intended preset to edit. Once the desired station is selected, use the VOLUME knob to either HIDE, SHOW, or ERASE that specific preset.

Tuner Setup Menu from Browser

Presets Edit

- At the top use the drop-down menu to select the preset you would like to edit. It will display as many as you have stored, which could be up to 30.
- On the left it will display the frequency and on the right you can choose to Show or Hide the volume from the drop-down menu.
- Below that is a button to erase the preset if you no longer want to have it saved.

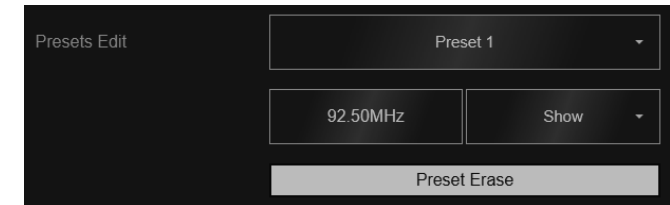

Navigating the Tuner Input

Selecting Tuner Input

The tuner input may be selected using the INPUT knob or the remote control's FM button.

Note: If the user selects tuner using the INPUT knob, they must press it briefly to enter the tuner control mode that allows the INPUT knob to be used to change stations. Another brief press and the knob returns to its previous state. This action is only required for the tuner input actions.

Manual Tuning

Press the directional up▲ or down▼ buttons on the inner ring of the remote control to navigate incrementally through stations.

Alternatively, while on the tuner input, Pressing the INPUT knob will activate and allow for navigation through FM stations by rotating the INPUT knob.

Automatic Tuning

Press the SEEK forward (>>) or the SEEK reverse (<<) buttons on the remote control to tune to the next available station, dependent on signal strength.

Storing Preset Station

To store an FM station in memory, Tune the MHT300 to the desired station. Using the remote control, press the PRESET button, the MHT300 will then store the station onto the next preset available (1-30). Alternatively, pressing PRESET on a station that has already been stored will erase that specific preset.

Preset Tuning

To navigate the MHT300's stored preset stations, use either the PRESET REVERSE (|<<) or the PRESET FORWARD (>>|) buttons to navigate up and down the next station stored in preset memory.

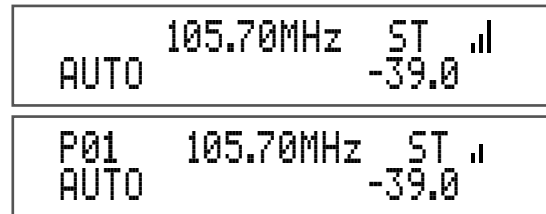

P01 = preset stored station #1
1-30 presets available to store

ST = "Stereo" radio signal vs "Mono"

Signal Strength

1 ▬ = Weak or none
2 ▬▬ = Medium
3 ▬▬▬ = Strong

AUTO = Surround mode
-39.0 = Volume



Amplifier Audio Specifications

Power Output

Minimum sine wave continuous average power output per channel, all channels operating is:
120 watts into a 8 ohm load
150 watts into a 4 ohm load

Output Load Impedance

8 and 4 ohms

Input Impedance

22k ohms

Rated Power Band

20Hz to 20,000Hz

Frequency Response

+0, -0.5dB from 20Hz to 20,000Hz

Total Harmonic Distortion

0.05% maximum harmonic distortion at any power level from 250 milliwatts to rated power, 20Hz to 20,000Hz

Dynamic Headroom

4dB - 4 and 8 ohm load

Input Sensitivity (for rated output)

1.6 Volt Unbalanced (8 ohm loudspeaker)
1.3 Volt Unbalanced (4 ohm loudspeaker)

Signal To Noise Ratio (A-Weighted)

85dB (95dB below rated output)

Wide Band Damping Factor

Greater than 100, at 8 ohms
Greater than 50, at 4 ohms

Voltage Gain

26dB

Intermodulation Distortion

0.2% maximum, if the instantaneous peak power output does not exceed twice the rated power output or less per channel with all channels operating for any combination of frequencies from 20Hz to 20,000Hz

Preamplifier Audio Specifications

Frequency Response

±0.5dB from 20Hz-20,000Hz

Total Harmonic Distortion

0.005% maximum from 20Hz to 20,000Hz at rated output

Signal To Noise Ratio - A Weighted

96dB below rated output

Output Impedance

330 Ohms

Maximum Output Voltage

8V Unbalanced

Coaxial/Optical Digital Input Rate and Formats

32kHz to 192kHz, 24-Bit PCM, Multichannel PCM, Dolby Digital, DTS

HDMI Input Rate and Formats

32kHz to 192kHz – 24-Bit PCM, Multichannel & Stereo PCM, Dolby Digital, DTS, Dolby Atmos, Dolby TrueHD, Dolby Digital Plus, DTS:X, DTS-HD Master Audio, DTS Express

Room Correction

Dirac Live

Video Specifications

HDMI (Inputs and Outputs)

Version 2.1, 8K, High Dynamic Range (HDR), Dolby Vision, HDR10, HLG, 4:4:4 Color, Rec. 2020, 3D Video pass-through, eARC, Dynamic Lip-sync

Fixed Rate Link (FRL)

40 Gbps
18 Gbps TMDS

Video Resolution

Up to 1080p 60/50Hz
4K 120/60/50/30/25/24Hz
8K 60/30Hz

HDCP

Version 2.3

General Specifications

Power Control Output

12VDC, 50mA maximum total

Power Requirements

100 – 120Volts / 220 – 240Volts
50/60Hz at 10 Amps
Standby: less than 0.5 watt

Overall Dimensions

Width is 17 ½ inches (44.5cm)
Width with side mount brackets 19 inches(48.3cm)
Height is 6 ¾ inches (15.7cm) including feet
Depth is 20 inches (50.8cm)

Weight

27 pounds (12.2 kg) net
43.5 pounds (19.7 kg) in shipping carton

Shipping Carton Dimensions

Width is 26 ½ inches (67.3cm)
Depth is 24 ¼ inches (61.6cm)
Height is 17 inches (43.2cm)

Packing Instructions

In the event it is necessary to repack the equipment for shipment, the equipment must be packed exactly as shown below.

It is very important that the four plastic feet are attached to the bottom of the equipment. This will ensure the proper equipment location on the bottom pad. Failure to do this will result in shipping damage.

Use the original shipping carton and interior parts only if they are all in good serviceable condition. If a shipping carton or any of the interior part(s) are needed, please call or write Customer Service Department of McIntosh Laboratory. Refer to page 2. Please see the Part List for the correct part numbers.

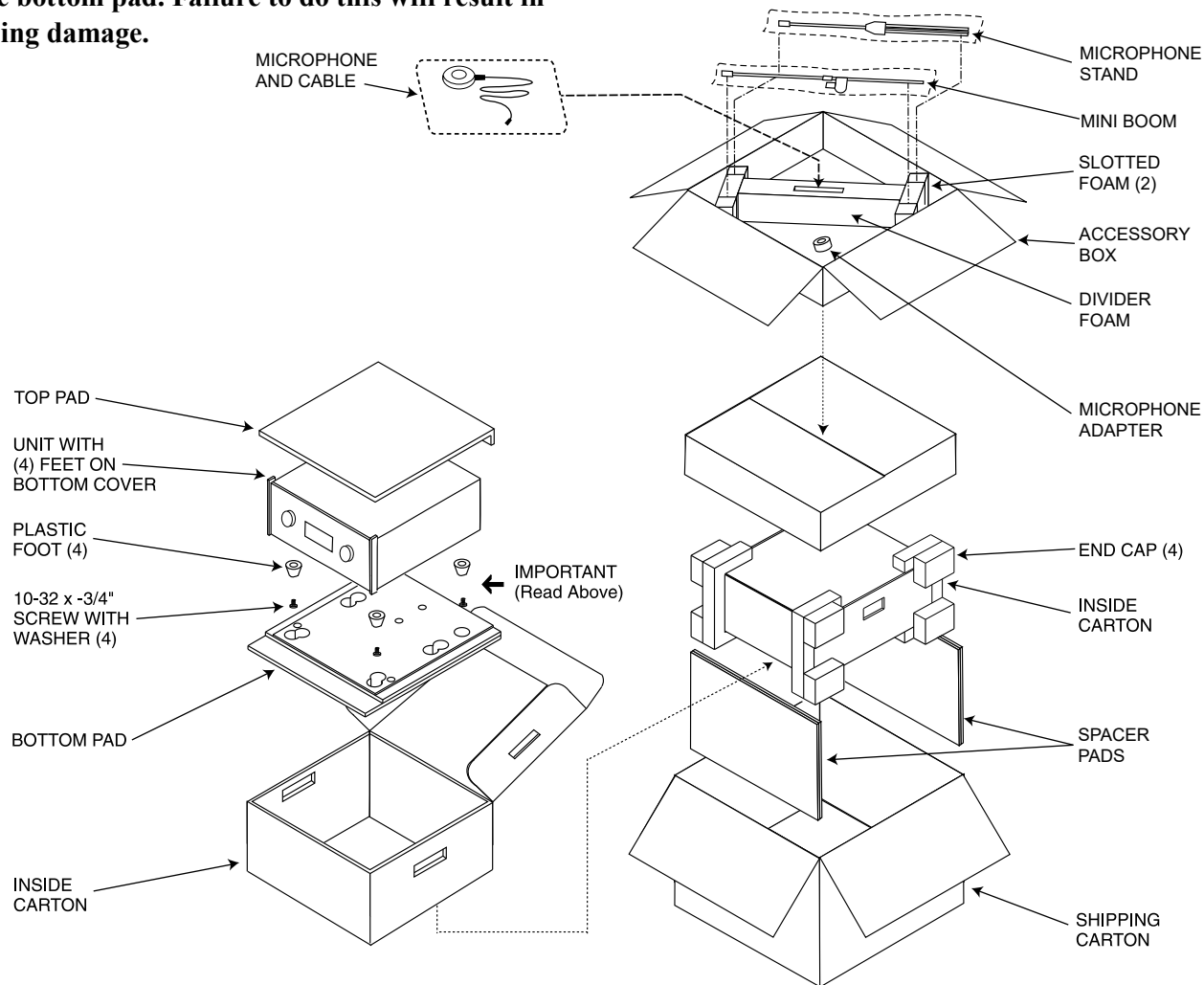

Part List

Qty	Part Number	Description
1	034492	Shipping Carton only
2	034669	End Caps
1	033836	Inside Carton only
1	033725	Top Pad
1	034576	Bottom Pad
4	017937	Plastic Feet
4	400159	#10-32 x 3/4" Screws
4	404080	#10 Flat Washers
1	034499	Accessory Box
2	034500	Slotted Foam
1	034501	Divider Foam
1	320338	Mic Stand Boom
1	320417	Adapter
1	320801	Microphone



McIntosh Laboratory, Inc.
2 Chambers Street
Binghamton, NY 13903
www.mcintoshlabs.com

The continuous improvement of its products is the policy of McIntosh Laboratory Incorporated who reserve the right to improve design without notice.

Printed in the U.S.A.