

**Attesa** Streaming Amplifier

**Attesa** Integrated Amplifier

Owners Manual

**ROKSAN**



# Contents

Introduction	1	USB	6
Unpacking	1	Headphone Output	6
Directives	2	12v Trigger	6
AC Mains Supply	2	IR Input	6
Maintenance	2	Power	6
Location	2	BluOS Playback	6
Streaming Amplifier Front Controls	3	MaestroUnite App	7
Streaming Amplifier Rear Connections	3	Operation	8
Integrated Amplifier Front Controls	4	OLED Display	8
Integrated Amplifier Rear Connections	4	Turning On & Standby	8
Remote Control	4	Volume Adjustment	8
USB Wi-Fi Dongle	5	Source Selection	9
Connecting to the Wi-Fi	5	Options Menu	10
Streaming Amplifier	5	MQA	14
Integrated Amplifier	5	Updates	15
Connections	5	Warranty	16
Loudspeakers	5	Troubleshooting	17
Signal	6	Specifications	18
LAN/ Ethernet	6		

## Introduction

Congratulations on your purchase of the Roksan Attesa Streaming or Integrated Amplifier. This product is designed and manufactured to the highest specification and rigorously tested to reward you with many years of listening pleasure.

Your Attesa Streaming or Integrated Amplifier is an integral part of your Hi-Fi system. Its correct installation, set-up and operation will have a significant influence on the performance of the entire Hi-Fi system. Please read the contents of this manual thoroughly. It will help you to understand your Hi-Fi equipment better and further enhance your listening pleasure.

## Unpacking

Included in the packing of your Streaming or Integrated Amplifier you will find:

- Mains lead(s) fitted with the correct mains power plug for your country.
- One Attesa Remote Control and 2 x AAA batteries
- USB Wi-Fi dongle and extension cable (Streaming Amplifier only)
- One information pack containing safety instructions and Quick Start Guide.

After removing these items please retain all packing material and instruction manuals. Correct packing is necessary for future transportation of your Streaming or Integrated Amplifier.

## Directives



Monitor Audio Group declares that the apparatus "Atessa Streaming Amplifier" and "Atessa Integrated Amplifier" in conformity with the essential requirements and other relevant provisions of Directive 2014/53/EU".



**NOTE:** This product must be earthed. Please ensure that other equipment connected to it is earthed according to the manufacturer's instructions.



Monitor Audio Group declare in own responsibility, that the Monitor Audio products described in this manual is in compliance with the following Standards and is in conformity with the essential requirements of the **Radio Equipment Regulations 2017**.

## AC Mains Supply

Your Atessa Streaming or Integrated Amplifier is set to operate from a fixed supply voltage which is marked on a label next to the mains input plug. The mains lead supplied with this product has an IEC C13 mains plug which is inserted into the Mains Input Socket on the unit's rear panel. The other end is a moulded plug appropriate to that for your country.

If your lead has been damaged please obtain a complete replacement lead from your dealer.

Should you move to another area where either the mains voltage or the mains plugs are different from those as supplied with your product, please contact the appointed Roksan distributor for assistance.



**Please observe correct mains polarity at all times.**

The mains fuses are located on the rear panel below the IEC Mains Input Socket. These must only be replaced by the fuse type and rating as described on the fuse rating label on the rear panel of the unit.

If the equipment is likely to be unused for some time, unplug it from the mains supply.



**NOTE:** This unit contains no user serviceable parts. Do not remove any panels or attempt to service it yourself. **Unauthorised servicing will void the warranty.**

## Maintenance

After disconnecting the product from the mains supply, the casing and front panel may be cleaned with a lightly dampened lint-free cloth. Furniture polish can also be used to clean the Streaming/ Integrated Amplifier. Avoid using abrasive substances or solvents.

## Location

Your Streaming/ Integrated Amplifier should be located in a well ventilated area and kept away from sources of heat, dust, humidity and direct sunlight.

The Streaming/ Integrated Amplifier may be positioned either as a free standing unit or alongside other audio/video product(s). Never place the Streaming/ Integrated Amplifier under other electronic equipment, carpet or any surface likely to hinder normal ventilation. Never allow liquids or other objects to fall into the unit.

When purchased with an Atessa CD Transport, we recommend placing the CD Transport below the Integrated/ Streaming Amplifier.

## Streaming Amplifier Front Controls

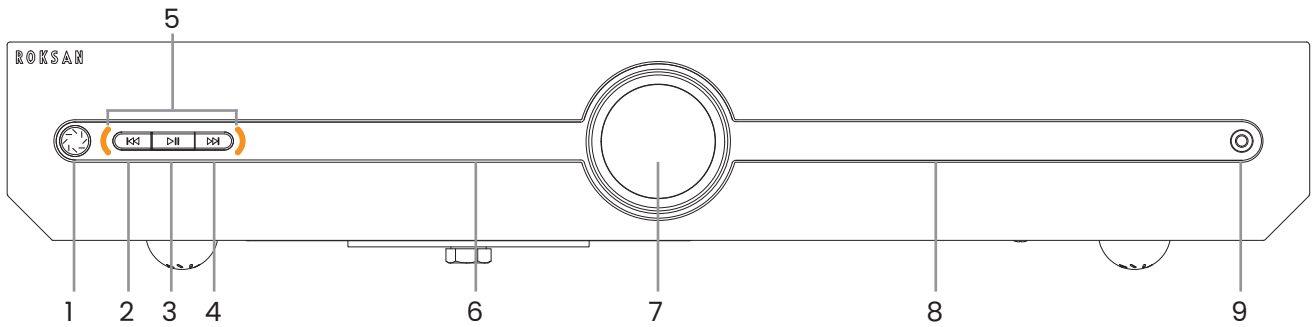

- |                          |                                 |
|--------------------------|---------------------------------|
| 1. Standby Button        | 6. OLED Display                 |
| 2. Previous Track Button | 7. Volume/ Input Selection Dial |
| 3. Play Pause Button     | 8. Volume Display               |
| 4. Next Track Button     | 9. Headphone Jack               |
| 5. Indicator LEDs        |                                 |

## Streaming Amplifier Rear Connections

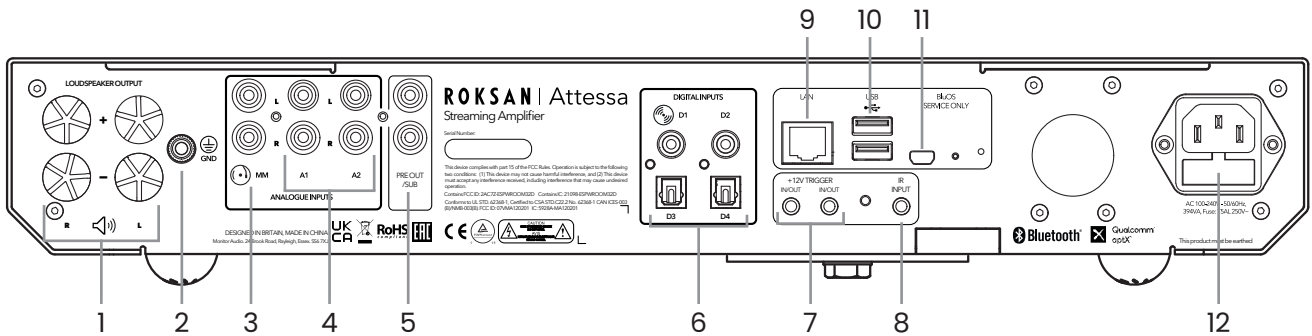

- |  |                                 |
|--|---------------------------------|
| 1. Loudspeaker Outputs   | 7. 12v Trigger Input/ Outputs   |
| 2. Turntable Grounding Post                                    | 8. IR Input                     |
| 3. Phono Input   | 9. LAN Input                    |
| 4. Analogue Inputs<br>(A2 - Auto Music Sense)                  | 10. USB Inputs                  |
| 5. Pre/ Sub RCA Outputs  | 11. BluOS Service Port          |
| 6. Digital Optical & RCA Inputs<br>(D1 - Attessa CD Transport) | 12. Mains Input & Fuse Location |

## Integrated Amplifier Front Controls

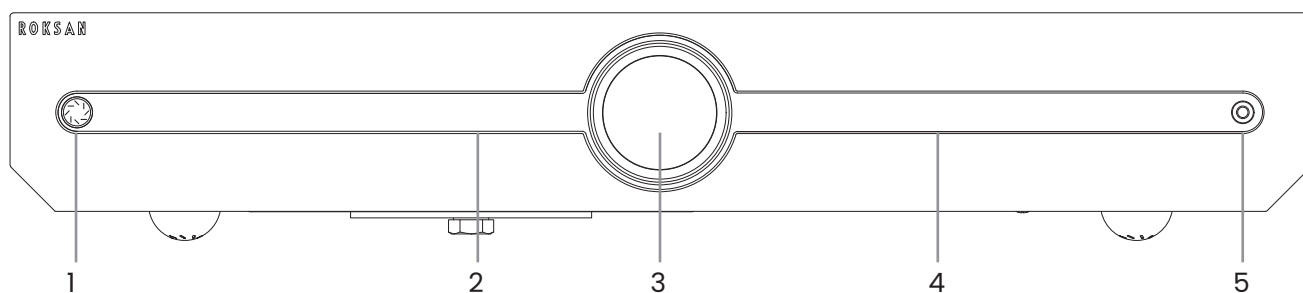

- |                                 |                   |
|---------------------------------|-------------------|
| 1. Standby Button               | 4. Volume Display |
| 2. OLED Display                 | 5. Headphone Jack |
| 3. Volume/ Input Selection Dial |                   |

## Integrated Amplifier Rear Connections

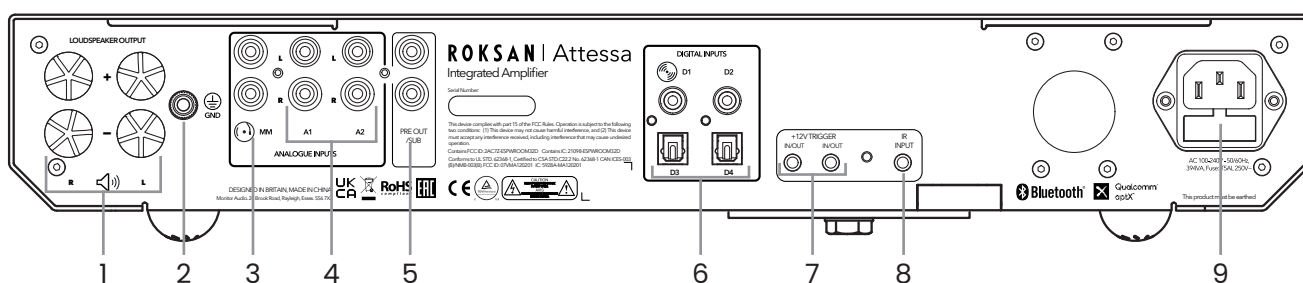

- |  |   |
|--|---|
| 1. Loudspeaker Outputs                     | 6. Digital Optical & RCA Inputs (D1 - Attessa CD Transport) |
| 2. Turntable Grounding Post                | 7. 12v Trigger Input/ Outputs                               |
| 3. Phono Input                             | 8. IR Input   |
| 4. Analogue Inputs (A2 - Auto Music Sense) | 9. Mains Input & Fuse Location                              |
| 5. Pre/ Sub RCA Outputs                    |   |

## Remote Control

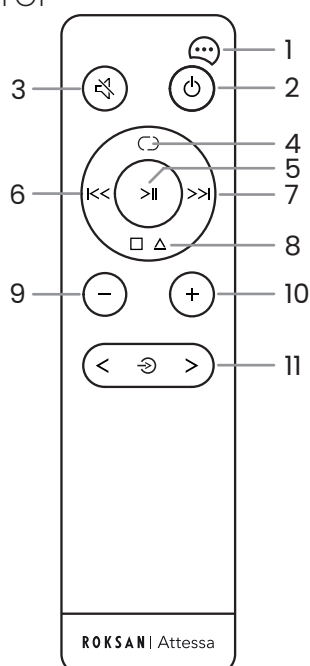

1. Settings Menu
2. Standby
3. Mute
4. Repeat All/ Repeat Track/ Shuffle
5. Play/ Pause
6. Previous/ Scan backwards
7. Next/ Scan forwards
8. Stop/ Open/ Close
9. Volume Down (Amplifiers only)
10. Volume Up (Amplifiers only)
11. Source Scroll Left & Right (Amplifiers only)

## USB Wi-Fi Dongle Streaming Amplifier Only

With the Streaming Amplifier we include a Wi-Fi dongle and small extension cable. To be able to stream music via BluOS, the Streaming Amplifier will need to be connected to your network, whether it is by the LAN Input or by Wi-Fi.

To connect the Streaming Amplifier to your Wi-Fi network, you will need to plug the dongle into the back of the amplifier. If reception is a bit weak or the Streaming Amplifier is in a cabinet, we would recommend using the provided extension cable.

## Connecting to the Wi-Fi

### Streaming Amplifier

There are two Wi-Fi modules inside the Attessa Streaming Amplifier. One is for BluOS, the other is for the Over The Air (OTA) updates. They should be configured at the same time using the MaestroUnite app as documented on Page 7. However, should you run into any issues and the BluOS module needs to be connected separately, please refer to the troubleshooting section later in this manual.

To set up for the OTA updates, you will need to download the MaestroUnite app from your app store. Once downloaded, follow the instructions to create a system and add the Streaming Amplifier to your Wi-Fi network.

### Integrated Amplifier

The Integrated Amplifier only has the Wi-Fi module for OTA updates. This is configured via the MaestroUnite app and cannot be used for streaming audio, it is only for OTA updates.

## Connections

### Loudspeakers

Connect the loudspeakers to the terminals on the Streaming/ Integrated Amplifier. Banana plugs can be used, but the red and black plastic caps need to be removed first. Once removed, insert the banana plug directly in to the terminal. Alternatively bare wire can also be used by unscrewing the terminal and placing the cable through the through hole in the terminal and clamping it firmly in place.

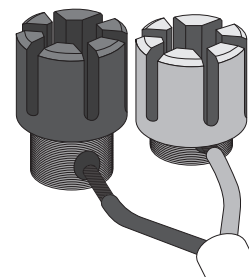

### Speaker Connection Polarity

Carefully observe polarity ensuring that the red (+) speaker terminal/ cable is connected to the red (+) amplifier terminal and the black (-) speaker terminal/ cable to the black (-) amplifier terminal.

When both left and right loudspeaker outputs are connected to their respective loudspeakers the amplifier is ready for use.

**!** **IMPORTANT:** Please ensure the unit is disconnected from the mains power supply before connecting the loudspeaker cables.

**!** **NOTE:** Litz-wound loudspeaker cables or those with a complex plaited construction can present a highly capacitive load to an amplifier and may cause damage to the amplifier and/ or degrade the sound of your system. Choose a cable of simple construction, manufactured from high-quality materials. Your ROKSAN retailer will be able to advise.

**!** **NOTE:** If using bare wire, DO NOT use speaker cable with conductor size less than 16 AWG (1.6 mm diameter) or greater than 12 AWG (2.05 mm diameter).

**!** **NOTE:** We strongly recommend that you use professionally terminated speaker cables using 4mm plugs. Any attempt to connect cables which are not terminated may result in damage to the amplifier if not done correctly.

## Signal

Connect the appropriate cables for your signal sources. If you have purchased the Attessa CD Transport as well, it is supplied with a coaxial digital cable. This can be connected directly to the D1 input.

When partnered with the matching Attessa Turntable, set turntable output switch to PASSIVE and connect to the Phono input, always use the supplied RCA cable as it is carefully matched to the response of the DANA cartridge when in passive mode.

If you are using another turntable without a built in phono stage, connect this to the analogue phono input and also connect the ground wire from the turntable to the grounding terminal on the back of the Streaming/ Amplifier. If it has a built in phono stage, then connect it to either A1 or A2 input.

The Attessa Turntable does not require a grounding cable.

## LAN/ Ethernet

(Streaming Amplifier Only)

For optimum network connectivity, Roksan recommend using a wired network connection. A network connection is needed for BluOS.

## USB

(Streaming Amplifier Only)

The USB connections can be used for connecting the USB Wi-Fi Dongle and/ or extension cable. A USB drive with audio on it can also be connected to the USB input and can be played from via the BluOS app.

## Headphone Output

Headphones can be connected to the Streaming/ Integrated Amplifiers by using the standard 3.5mm headphone jack on the front of the product. When connecting headphones the speaker outputs will automatically mute and the volume output goes to 'safe' headphone level. The Volume Display will change to new volume level. Likewise when the headphones are removed, the speaker output level will be returned to a 'safe' level.

 **IMPORTANT: Do not have the headphones connected and in use when carrying out a factory reset or firmware update.**

## 12v Trigger

These 3.5mm jack connections can be used to remotely turn the Streaming/ Integrated Amplifiers on and off by supplying a 12v signal to them. The output link will only work if there is an input to the product.

Either socket can be used for the input with its partner being used as the linked output, as a convenience to allow a single 12V trigger output from a partnering system to be distributed (to a sub-woofer perhaps) with a second cable.

## IR Input

If the product is in a different room or cabinet, IR commands can be sent to the unit electrically via the rear panel jack socket labelled Wired IR. Wired IR is compatible with many home automation installations including Logitech Harmony, early Crestron and Control 4 installations. The Wired IR jack socket is an input only and does not provide power, therefore, unsuitable for some remote IR-eye connections that are not self-powered.

## Power

The moulded IEC plug of the supplied mains lead should be plugged into the socket on the rear of the unit first and then plugged into the mains supply.

The mains fuse is located here in the small drawer attached to the mains input socket. The fuse is a T5AL type.

 **NOTE: When entering standby, 10 - 15 seconds after the power button LED turns red, the loudspeaker cones will move in and out. This is perfectly normal and will not cause any harm to the loudspeaker or the amplifier.**

## BluOS Playback

(Streaming Amplifier only)

To take full advantage of the Streaming Amplifier's capabilities and features, you can use it as a music streamer with the BluOS app. The app can be downloaded from your Apple, Android and Microsoft App Store. Once downloaded follow the on-screen instructions to install and set up the app for use with your Attessa Streaming Amplifier.

When Standby Plus is enabled, the Streaming Amplifier will be visible within the BluOS app and can be woken from standby using it and begin playback.



**!** **IMPORTANT:** For the app to find the Streaming Amplifier, you will need to select the BluOS input.

The BluOS module inside the amplifier has an LED that is visible through the chassis. This provides constant feedback with the connection status of the BluOS module. Below are a list of colour and flash combinations. It can also be turned off or dimmed within the BluOS app menu.

**Solid Green:** The Player is in Hotspot Mode and is ready to be connected to the network. To setup your player from Hotspot Mode, check out the wired or wireless setup options in the following support article.

<https://support.bluos.net/hc/en-us/articles/360000057968>

**Flashing Green:** The Player is attempting to connect to the network or the network cable is disconnected.

**Solid Purple:** The Player is not set up but Hotspot Mode has timed out after 15 minutes of idle.

**Solid Blue:** The Player is in Ready Mode connected to the network and ready to stream music.

**Flicker Blue:** Receiving IR Codes from a remote

**Blinking Blue:** The Player is Muted

**Solid White:** The Player is indexing the local music library on your network

**Alternating White and Blue:** Player is replicating or receiving an updated Index from other players

**Solid Red:** The Player is in Upgrade Mode waiting to perform an upgrade. If your player has entered Upgrade Mode unexpectedly, please check out the following support article

<https://support1.bluesound.com/hc/en-us/articles/204492653-My-Bluesound-Player-s-Mute-LED-Button-stays-Red-when-Upgrading>

**Alternating Red/Green:** The Player's BluOS firmware upgrade is in progress.

## MaestroUnite App

The Attesa range is accompanied by the MaestroUnite app. This app is used to create systems of CD Transports, Integrated and Streaming Amplifiers. It will also be the home to all user manuals, OTA (Over The Air) updates and connecting the devices to the Wi-Fi network.

The mobile app is available for iOS and Android devices in your usual app store.

Once installed, follow these steps to create your Attesa system:



1. Touch on the "+" to start creating a System and name it.

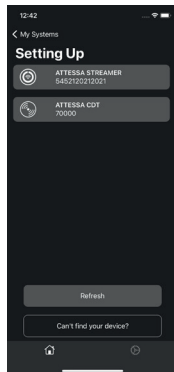

2. Select the first product to add to the system.

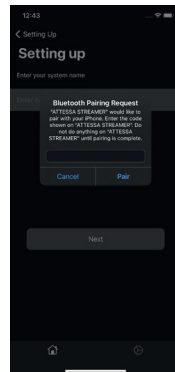

3. Connect via bluetooth by entering the code on the screen of the product

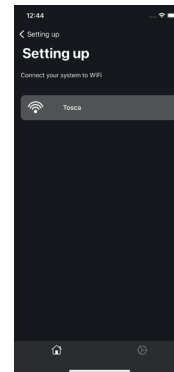

4. Join your local Wi-Fi network

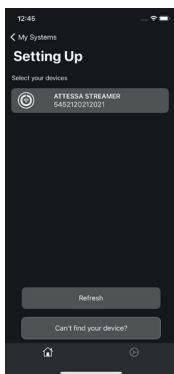

5. Add the next product and connect to it via Bluetooth as done previously

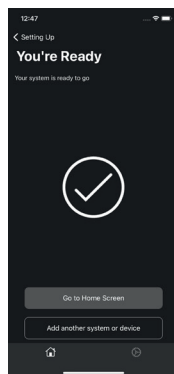

6. Once 2 products have been added, You're Ready. Touch home

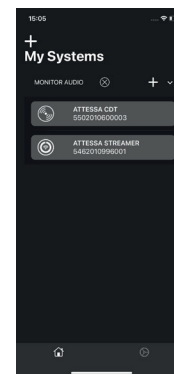

7. Your systems are visible in the home screen where you can select products to customise them

**!** **NOTE:** When in a "System" the IR receiver is turned off on the CD Transport and the commands are sent by BLE (Bluetooth Low Energy) from the Streaming/ Integrated Amplifier. The Indicator icons on the CD Transport will not operate when part of a system except when the CDt input is selected on the Streaming/ Integrated amplifier when they will become operational.

## Operation

### OLED Display

To preserve the life of the OLED display, there is an automatic display saver mode.

If there are no commands received for 2 minutes the display will turn off until a command is received.

### Turning On & Standby

A single press of the standby button on the unit or single press of the standby button on the remote will wake the unit from standby and the button LED will turn solid orange. The Roksan logo will also appear on the display to the left of the Volume/ Input Selection Knob followed by the A2 Input (when used for the first time or when the power is removed) or the last used input if woken from standby.

A single press of the Standby Button on the unit or single press of the Standby Button on the remote and logo will turn solid red and the display will go off and the unit will enter standby mode.

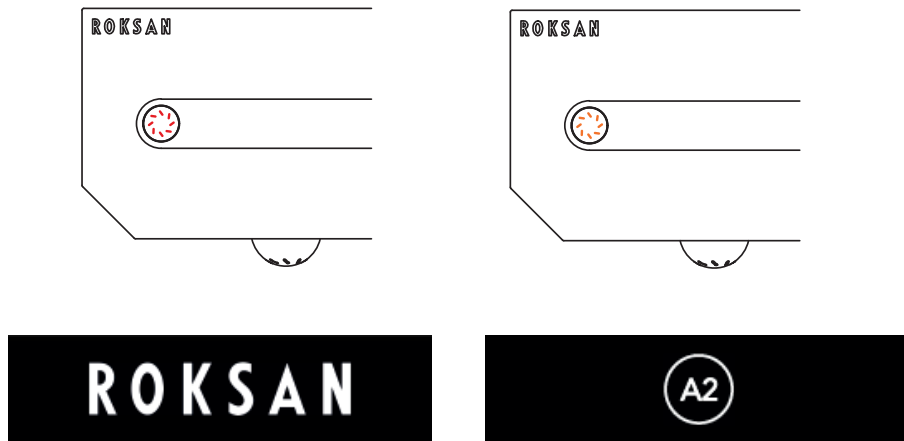

### Volume Adjustment

Volume adjustment is achieved by either rotating the Volume/ Input Selection Knob (clockwise to increase the volume and anti-clockwise to decrease the volume) or by pressing the buttons on the remote. The Volume LEDs will be illuminated on the right hand side of the Volume/ Input Selection Knob showing the current volume.

The volume can be muted by turning the knob anti-clockwise or by pressing the Mute button on the remote control. A momentary press of the encoder will also put it into mute and take it out of mute.

**NOTE:** If the unit is turned off with the volume above 75%, it will restart at a lower level to protect the speakers and the Integrated Amplifier/ Streaming.

## Source Selection

The various sources can be selected by pressing in, holding and rotating the Volume/ Input Selection Knob clockwise or anti-clockwise. You will get haptic feedback as a different input is scrolled past. They are also accessed by pressing the Source Scroll buttons on the remote. A1 is the default input unless Standby Plus is enabled with the 12v Trigger off, when it will be A2 (for Music Sense). When going into standby, the amplifier will remember its last selected input.

They will scroll through in the below order:

Phono < A1 > A2 > CD (D1) > D2 > D3 > D4 > Bluetooth > BluOS > Preset 1 > Preset 2 > Preset 3.

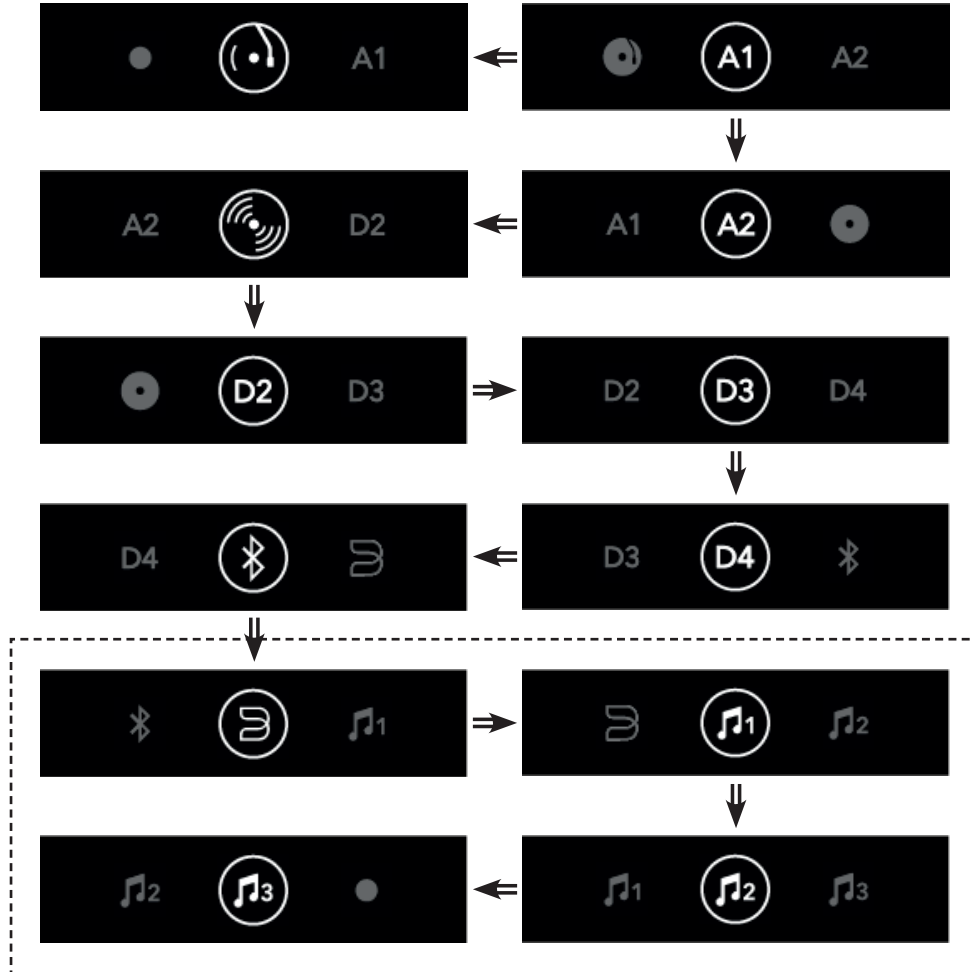

**NOTE: BluOS, Presets 1, 2 & 3 are on the Streaming Amplifier only.**

## Options Menu

The Settings Menu button on the remote brings up some customisation options for the Streaming/ Integrated Amplifier, these are:

- 12v Trigger
- Wired IR
- Standby Plus
- Auto Standby
- Headphone Sensitivity
- A1 Sensitivity
- A2 Sensitivity
- MM Sensitivity
- Balance
- AV Bypass
- MAC Addresses
- Firmware Versions
- BluOS Version & IP Address (Streamer only)

Some features can also be accessed via the Maestro Unit App.

Once in the Settings Menu, use the previous and next track buttons to scroll through the options and the Play/ Pause button to toggle the features on and off.

### 12v Trigger

If using the 12v Trigger feature to turn the Streaming/ Integrated Amplifier on and off, you must first enable it here (or within the MaestroUnite app). It is toggled on and off by pressing the Play/ Pause button on the remote or via MaestroUnite. It can only be turned on or off.

**NOTE: Music Sense on A2 will not work when the 12v Trigger is turned on.**

**NOTE: 12v trigger will take precedent over the Auto-Standby setting. e.g. 12v trigger ON & 12V trigger input is high the auto-standby timer is disabled**



### Wired IR

If using an externally wired IR receiver with the Streaming/ Integrated Amplifier, this must be turned on here (or within the MaestroUnite App) which will disable the built in IR receiver. It is toggled on and off by pressing the Play/ Pause button on the remote or via MaestroUnite.



### Standby Plus

This feature enables a variety of features.

- MaestroUnite Systems to turn on from standby and share status while in standby
- A2 automatic Music Sense (only if 12V trigger is OFF)
- BluOS visible on the network and wake from standby

With the feature turned on, the Streaming/ Integrated Amplifier will consume a little more power (see specifications) but is in a ready state to be able to be woken from standby by the MaestroUnite app, music sense or BluOS apps.

When Standby Plus is off, the BLE communication with the MaestroUnite App and the other units in the system will not work.

It is toggled on and off by pressing the Play/ Pause button on the remote or via MaestroUnite.



**NOTE: Of the wired inputs, only A2 has automatic music sense.**

How the 12v Trigger and Standby Plus interact with each other can be seen in the table below:

	12V Trigger OFF	12V Trigger ON
Standby Plus OFF	Music Sense OFF	Music Sense OFF
Standby Plus ON	Music Sense ON	Music Sense OFF

### Auto Standby

Here you can control the Auto Standby feature of the Integrated/ Streaming Amplifier. It is on by default and the amplifier will go into standby mode if no signal is received for 20 minutes. If Auto Standby is turned off, then the amplifier will never go into standby unless it is done manually using the remote or power button on the amplifier itself or it is controlled by the 12v Trigger.

12V trigger will still control power even if this is set to Auto Standby OFF.



### Headphone Sensitivity

The headphone sensitivity level is adjusted here to cater for the variety in headphone sensitivity and perceived listening levels. We would recommend having it set to low for ear buds and for over the ear type headphones, mid to high. It is to help give the same level for loudspeakers as headphones according to the volume display. When headphones are connected, the volume will reduce to a low level (4 bars illuminated) and will return to the previous level when the headphones are removed.

The levels are changed by pressing the Play/ Pause button on the remote or via MaestroUnite.



### A1, A2 Sensitivity

As with the headphone output, the sensitivity of these three inputs can also be adjusted between Low, Mid and High. By default it will be set to "Low" for use with most sources that use a ~3 VRMS line level input. Mid sensitivity should be used when the source has an output voltage of ~1.5 VRMS. High Sensitivity should then be used when the source has low output levels around 0.75 VRMS.

The levels are changed by pressing the Play/ Pause button on the remote or via MaestroUnite.



## MM Gain

The phono stage's Moving Magnet (MM) Gain adjustment is to allow for the varying output voltages of phono cartridges. It will be set to Mid by default which is for cartridges with an output of around 6 mV max which will be the setting needed for any Roksan Cartridge for example, Corus 2 or Dana.

The "Low Gain" setting should be used with cartridges that have a high output level of around 12 mV.

The "High Gain" setting to be used with 3 mV cartridges.

The levels are changed by pressing the Play/ Pause button on the remote or via MaestroUnite.



## Balance

Here the balance of the Streaming/ Integrated Amplifier can be tailored to suite the room/ set up by adjusting it to sound central from your listening position. From the central position it can be adjusted 3dB to either the left or the right channels.

The levels are changed by pressing the Play/ Pause button on the remote or via MaestroUnite.

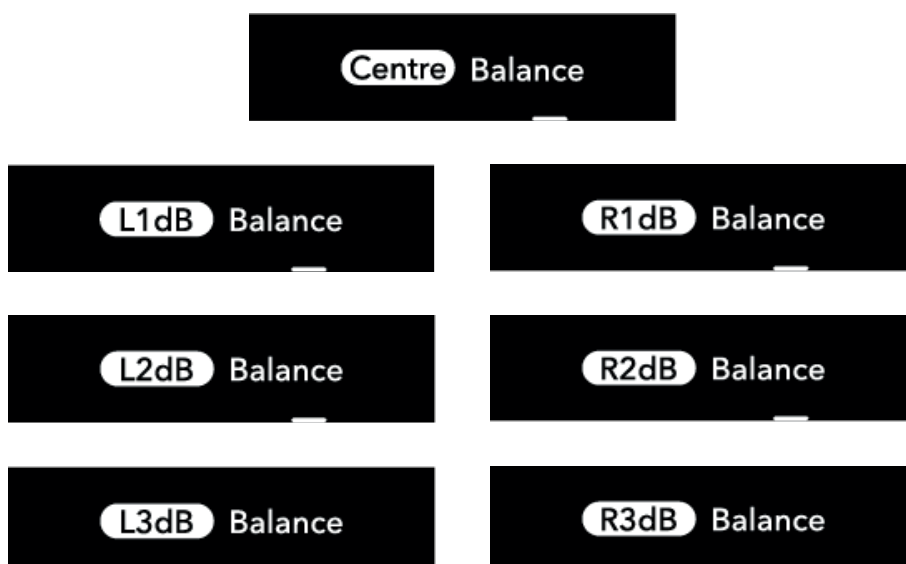

## AV Bypass

**WARNING:** If you are going to enable AV Bypass for A2, please ensure all amplifiers are turned off at the mains before connecting any signal cables between the amplifiers.

**WARNING:** Ensure the volume of the AV receiver is set to minimum when first setting this feature up or will risk damaging your amplifiers, speakers and potentially hearing.

When using the Streaming/ Integrated Amplifier as part of a home cinema system with an AV receiver, the A2 input can be used to drive 2 channels with the AV receiver driving the rest. Here, the AV Bypass mode will need to be turned on and the appropriate RCA outputs from the AV Receiver will need to be connected to A2. When in use, A2 should be the selected input and will have the Mute icon next to it. The three further most right Volume Display bars will also be fully illuminated.

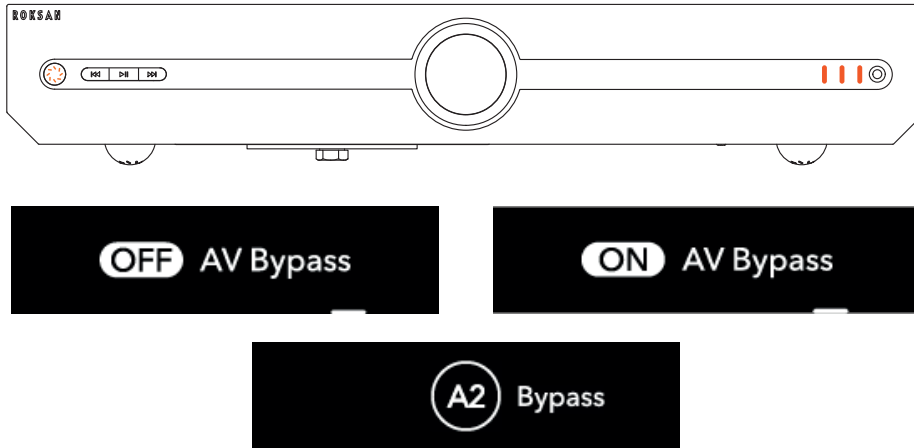

It is also recommended to turn on and use the 12v Trigger when using this feature. If your receiver only has one 12v Trigger output and you still want to trigger your subwoofer, use the output on the amplifier to link round to the subwoofer.

**NOTE:** The headphone jack will be disabled when in AV Bypass mode for A2 input. If you plug in a headphone jack whilst in AV Bypass mode, the loudspeaker outputs, line output & the headphone output will mute. Nothing will change on the screen or volume bar.

**NOTE:** For AV bypass to be fully enabled, you will need to cycle out of A2 into another input and then back again. The display will then appear as it is above and the gain of the amplifier set to maximum.

## MAC Addresses

Here you will find the MAC addresses for the Wi-Fi and bluetooth modules.

WiFi: fc:f5:c4:65:8d:e4  
BT: fc:f5:c4:65:8d:e6

## Firmware Versions

Here the firmware versions for the Streaming/ Integrated Amplifier and the CD Servo.

MCU:3.0.5  
FIX: 0423d1

## BluOS Version & IP Address

This is on the Streaming Amplifier only and is where you will find the version of BluOS firmware and also the IP address of the BluOS unit assigned by your router.

BluOS: 3.14.26  
IP: 192.168.0.27

NOTE: Firmware versions and MAC addresses are for illustrative purposes only.

## MQA

Master Quality Authenticated  
(Streaming Amplifier only)

MQA is an award-winning British technology that delivers the sound of the original master recording. The master MQA file is fully authenticated and is small enough to stream or download. Visit [mqa.co.uk](http://mqa.co.uk) for more information.

The Attesa Streaming Amplifier includes MQA technology, which enables you to play back MQA audio files and streams, delivering the sound of the original master recording. All of the digital audio sources of the Streaming Amplifiers support MQA content, there are two types of MQA: 'MQA' or 'MQA.' MQA indicates that the product is decoding and playing an MQA stream or file, and denotes provenance to ensure that the sound is identical to that of the source material. 'MQA.' indicates it is playing an MQA Studio file, which has either been approved in the studio by the artist/producer or has been verified by the copyright owner.

'OFS' (Original Sample Rate) confirms that the product is receiving an MQA stream or file. This delivers the final unfold of the MQA file and displays the original sample rate.



## Customisation

Within the MaestroUnite app, it is possible to customise some of the settings also found in the Options Menu on the products display. You can also customise the input symbols from a library of icons we have created. To do this within the MaestroUnite app, go to My System and then touch the product you wish to adjust the settings of/ customise.

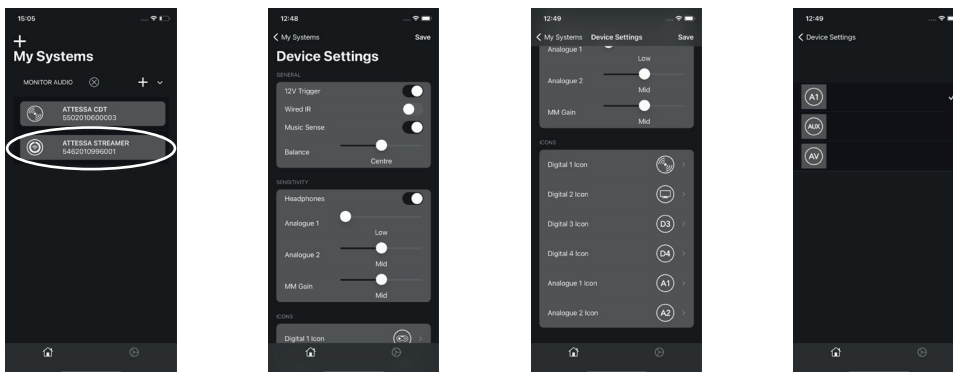

## Alternate Icons

Below are the alternate icons that can be used on the Streaming/ Integrated Amplifier for the various different sources. Aux, AV, Games Console, Laptop/ PC, TV

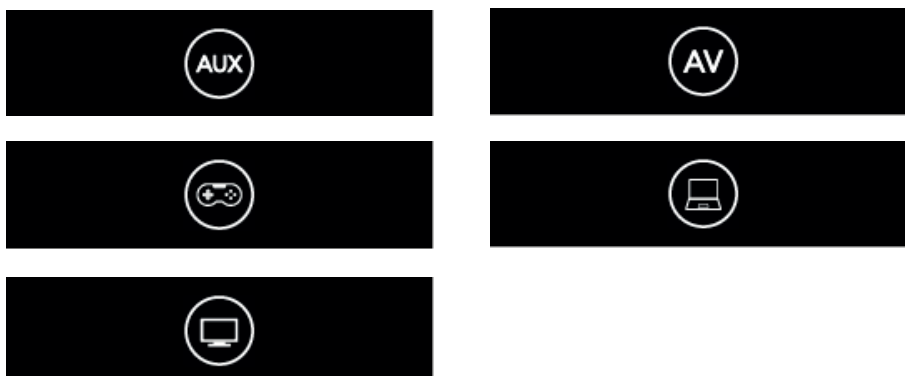



## Updates

The MaestroUnite app will notify you if there is a new Roksan Firmware update for the units and the BluOS app will notify you of an update to the BluOS module.

Both the Streaming and Integrated Amplifiers need to connect to the internet to receive the updates. This is done as part of the setup of the MaestroUnite app.

**!** **NOTE:** The Integrated Amplifier only has access to the internet during the updating procedure. There is no other way or need for it to connect to the internet.

If you want to manually search for an update on the Streaming/ Integrated Amplifier, press and hold the standby button until the LED in it turns blue. If there is an update available, the display will then scroll through the following messages:

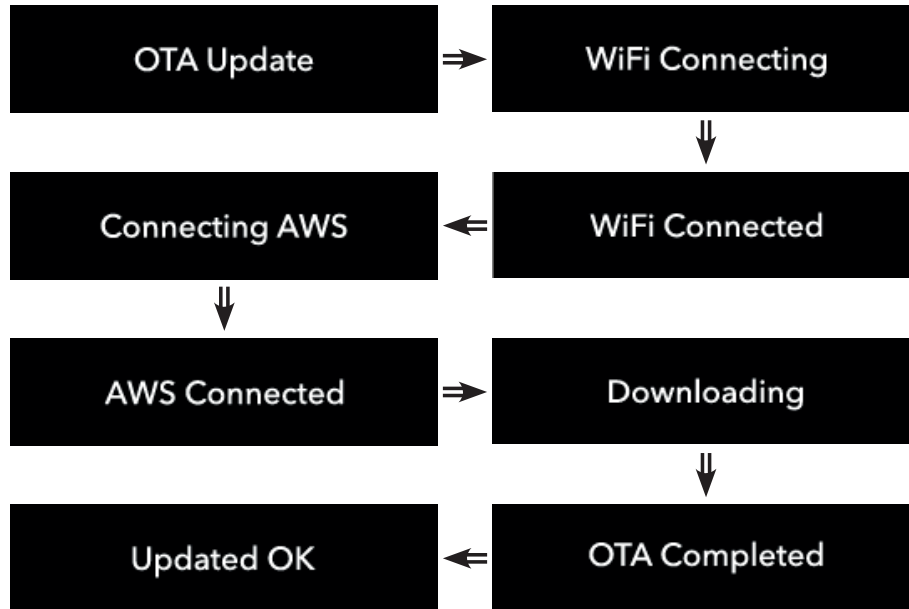

If there isn't an update you will be informed that there isn't one available.



Likewise if there is an error, you will also be informed of this.



## Factory Reset

Should the need arise to carry out a factory reset on your Attessa Streaming/ Integrated Amplifier, please follow these simple steps.

1. Hold the standby button down for about 20 seconds. The Power Button LED will turn blue, keep the button pressed.
2. There will be a message appear saying "Hold For Factory Reset" and the LED will turn green. Keep the button pressed in.

**Hold For Factory Reset**

3. Next a message saying "Factory Reset". Release the button now and the Streaming/ Integrated Amplifier will restart.

**Factory Reset**

4. To complete the procedure, remove the mains supply from the product once it has gone into standby. Then reconnect it and turn on from stand by.

 **NOTE:** all Wi-Fi details will be erased as well as any other settings and customisation.

## Warranty

Both the craftsmanship and the performance of this product is covered by the manufacturer's warranty against manufacturing defects provided that the product was supplied by an authorised Roksan retailer under the consumer sale agreement. For the period of cover please refer to the product page on our website: [roksan.com](http://roksan.com) for the product you have purchased.

When purchasing Roksan products, please keep your receipt of purchase safe, as this validates your warranty.

The words 'consumer sale' shall be construed in accordance with section 15 of the supply of goods act 1973. Roksan accepts no responsibility for defects arising from accident, misuse, abuse, wear and tear, modification or operation outside of that specified within this instruction manual. Neither will responsibility be accepted for damage or loss occurring during transit to or from the parties claiming under this guarantee.

This guarantee covers both labour and parts. The liability of Roksan is limited to the cost of repair or replacement of the defective parts (at the discretion of Roksan) and under no circumstances extends to consequential losses or damage.

## Troubleshooting

Within this trouble shooting section there will be a full explanation of each of the error states and messages that the Integrated Amplifier and Streaming can display.

### Over temperature

This is where the amp has got too hot due to being played for long periods of time and/ or at high levels. Additionally, this can also happen if something has covered it to stop the air escaping from the unit. The following icon will appear and the amplifier will enter a Muted state for 15 minutes to cool down.



If the over temperature warning appears, there will be a message displayed and the amplifier will be functional again after acknowledging the message by pressing the standby button. The volume will automatically set to 1/3 volume when restarting.

### Over Current

This can be caused by a short circuit on the speaker cables/ terminals or by DC. The following icon will appear and the unit will enter a muted state.



Check the speaker cables in the first instance and try to restart the unit.

### High Mains Voltage

If the mains input is too high at start up (only time this error should occur), the icon below will appear and the unit will not power on.



To reset this error, remove the power from the unit and try again later.

For information on working voltage ranges refer to the specifications.

### Low Mains Voltage

If the mains input is too low at start up (only time this error should occur), the icon below will appear and the unit will not power on.



To reset this error, remove the power from the unit and try again later.

For information on working voltage ranges refer to the specifications.

### BluOS not connecting to Wi-Fi

Should you find that the BluOS module isnt connecting to the Wi-Fi, follow the instructions under "Wireless Manual Setup"

<https://support.bluos.net/hc/en-us/articles/360000057968-How-do-I-connect-my-BluOS-Player-to-the-network->



## Specifications

### Power Amplifier

Power Output into 8 Ohm:	80 Wrms per Channel, Both Channels Driven, Nominal (THD+N <1%)
Power Output into 4 Ohm:	130 Wrms per Channel, Both Channels Driven, Nominal (THD+N <1%)
THD+N:	<0.02% (1 kHz, 2 channels, 1 W @ 8 Ohms, A-Weighted)
Amplifier Type:	Class AB
Gain:	29 dB
Channel Matching:	<0.5 dB
Signal to Noise Ratio:	>80 dBa 1 W/ 8 R, >98 dBa 75 W/ 8 R
Channel Separation:	>75 dB @10 kHz
Frequency Response:	5 Hz to 50 kHz (-3 dB)

### Pre-Amplifier\*

Volume Channel Matching:	<0.25 dB
THD+N:	0.002% (1 kHz, 2 Vrms, A-Weighted)
Channel Separation:	>102 dB (1 kHz, 100 mV)
Signal to Noise Ratio:	>104 dB (unweighted)
RIAA (Phono):	47 kΩ/ 56 pf loading; gain settings suitable for 12 mV, 6 mV, 3 mV output cartridges

\*measured at the Pre-Out

### BluOS

(Streaming Amp ONLY)

Audio Formats	MP3, AAC, WMA, OGG, WMA-L, ALAC, OPUS
Hi-Resolution Audio Formats	MQA, FLAC, WAV, AIFF, Supports converted DSD playback via the BluOS desktop app (only)
Sampling Rate	Up to 32 bit / 192 kHz
Supported Operating Systems.	Plays music from network shares on the following desktop operating systems: Microsoft Windows XP, 2000, Vista, 7, 8 to current Windows Operating Systems and Mac OS X versions
Mobile Device Support	BluOS App – free on Android & iOS, available within Google Play & Apple App Store
Mobile Device Control	BluOS application can control inputs, volume and configure BluOS related settings
Supported Cloud Services	Amazon Alexa, Amazon Music, Spotify, TIDAL, Deezer, Qobuz, HDTracks, HighResAudio, Murfie, JUKE, Napster, Slacker Radio, KKBox, Bugs
Free Internet Radio	TuneIn Radio, iHeartRadio, Calm Radio, Radio Paradise
Control Integrations	Crestron, Control4 (OS 3), Control4 (2.9.1), RTI, URC, Push, Lutron, ELAN, iPort

### Bluetooth

Bluetooth:	A2DP Audio profile
Bluetooth Codecs:	SBC, aptX & AAC
Bluetooth Range:	15 m (typical, clear line of sight)

### Digital Inputs

Digital Coax Input:	up to 24 bit/ 192 kHz PCM
Digital Optical Input:	up to 24 bit/ 96 kHz PCM

### DAC

Format Support:	PCM
Sampling Rate:	up to 192 kHz/ 24 bit
THD+N:	0.001% (1 kHz, 2 Vrms at Pre-Out)
Signal to Noise Ratio:	106 dB (A-Weighted)

**Other**

IR Receiver	5V – 14V, mono 3.5mm jack plug, any polarity
12V Trigger Input	5V-14V, 3.5mm jack dual polarity
12v Trigger Output	3.5mm jack Pass through from input only
Construction	Formed plated steel and bespoke machine anodised aluminium front panel
Dimensions (H x W x D) (Inc Feet, Connectors & Buttons)	76 x 432 x 373 mm 3 x 17 x 14 <sup>11/16</sup> Inches
Streaming Amplifier Weight	10.48 Kg 23 lb
Integrated Amplifier Weight	10.37 Kg 22 lb 14 oz
Mains input (Auto Selecting)	100-130 VAC 50/60 Hz 210-240 VAC 50/60 Hz (Operational down to 85 VAC with reduced output power)
Power consumption	Full Power: 400 W max Standby: <0.5 W Network Standby: 6 W

Roksan  
24 Brook Road  
Rayleigh, Essex  
SS6 7XJ  
England  
Tel: +44 (0)1268 798900  
Email: [info@roksan.com](mailto:info@roksan.com)  
[roksan.com](http://roksan.com)

©Monitor Audio Group Ltd. VI-2021

Tested against version 3.0.0 Chassis Firmware

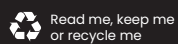

UK  
CA