

AXA35

Manual Generated: 22/02/2023 - 10:55

Table of Contents

AXA35	3
Introduction	4
What's included with the AXA35?	5
Front panel controls	6
Rear panel connections	8
Remote control	10
Getting connected	11
Operating instructions	14
Technical specifications	16
Troubleshooting	18
Frequently Asked Questions (FAQ)	19

AXA35

Last updated: August 2, 2022 02:05. Revision #7834

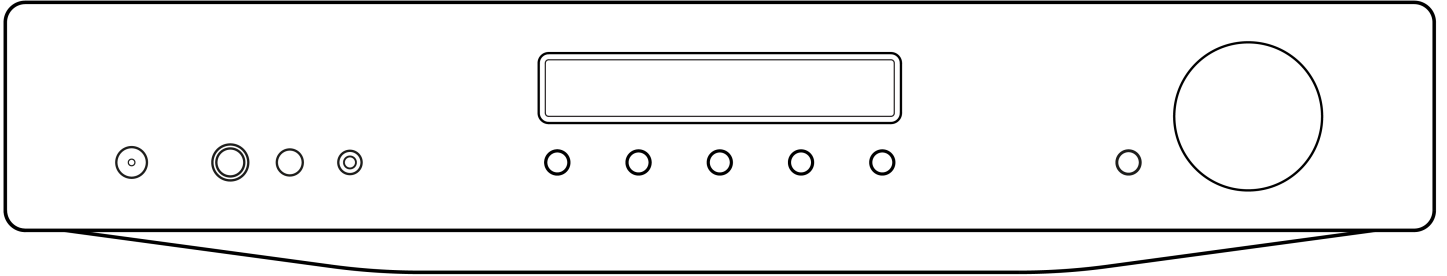

Users Manual

Introduction

Last updated: July 29, 2022 10:25. Revision #7843

This guide is designed to make installing and using this product as easy as possible. Information in this document has been carefully checked for accuracy at the time of printing; however, Cambridge Audio's policy is one of continuous improvement, therefore design and specifications are subject to change without prior notice.

This document contains proprietary information protected by copyright. All rights are reserved. No part of this manual may be reproduced by any mechanical, electronic or other means, in any form, without prior written permission of the manufacturer. All trademarks and registered trademarks are the property of their respective owners.

© Copyright Cambridge Audio Ltd

For upcoming news on future products, software updates and exclusive offers, make sure you register your product at <https://www.cambridgeaudio.com/register>

What's included with the AXA35?

Last updated: July 29, 2022 10:25. Revision #7842

Inside the box of your AXA35 you will receive:

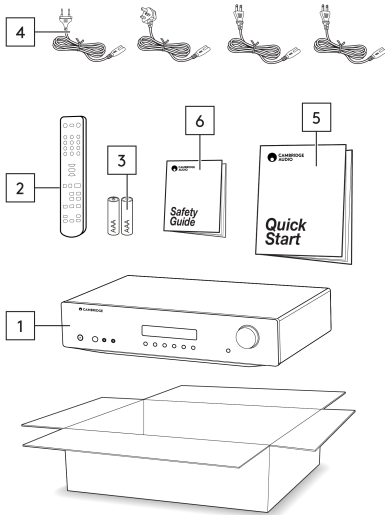

1. AXA35 integrated amplifier.
2. Remote control.
3. 2 x AAA batteries.
4. UK mains lead (depending on which country the AXA35 was purchased).
EU mains lead (depending on which country the AXA35 was purchased).
CU mains lead (depending on which country the AXA35 was purchased).
JP mains lead (depending on which country the AXA35 was purchased).
5. Quick start guide.
6. Safety guide.

Front panel controls

Last updated: August 1, 2022 04:15. Revision #7841

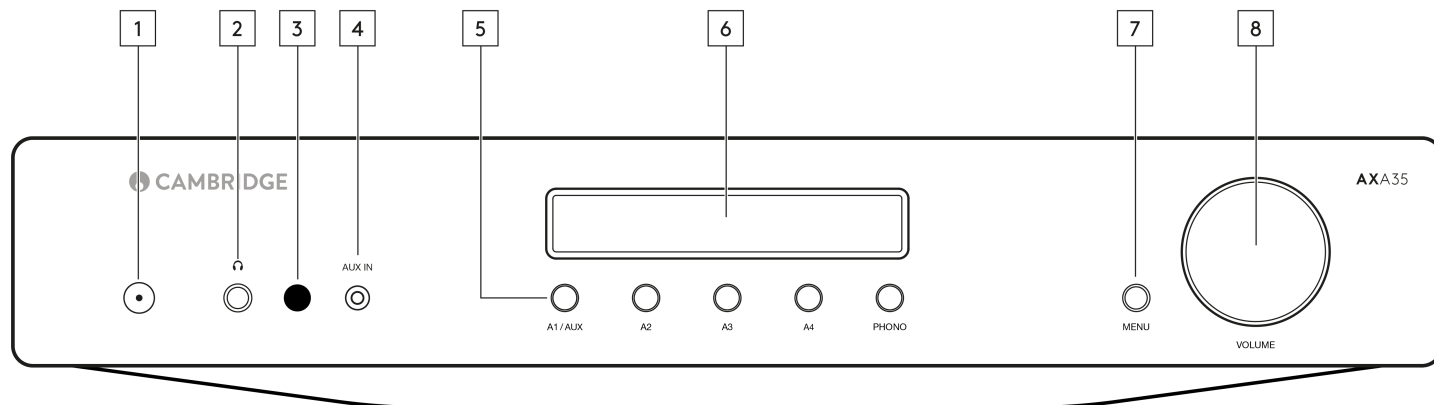

1. Power button - Switches the unit between Standby mode (indicated by dim LED) and On (indicated by bright LED). Standby mode is a low power mode where the power consumption is less than 0.5 Watts.

This product has APD (Auto Power Down) enabled as default. After inactivity of 20 minutes, the product will automatically switch to Standby.

Auto Power Down (APD)

You can enable and disable the unit's APD setting. This can be adjusted by pressing and holding the Power button until the LED flashes in sequence. The two options below show which option is selected.

Standby flashes 5 times - APD disabled

Standby flashes 10 times - APD enabled

Note: Make sure the unit is On, before making changes to the APD function.

2. Headphone socket - This socket allows for the connection of stereo headphones with a 1/4 inch jack plug. Headphones with an impedance of between 32 and 600 ohms are recommended.

Note: Connecting headphones will automatically mute the loudspeaker outputs.

3. Infrared sensor - Receives IR commands from the supplied remote control.

An unobstructed line of sight between the remote control and the sensor is required.

4. Aux in -

This source input allows you to connect a portable audio device, such as a smart phone, directly into the front of the unit using a 3.5mm stereo Aux lead.

Once plugged in, this input is automatically selected, although other inputs apart from A1 can still be selected once a stereo-jack is plugged in. The A1/AUX button on the front of the unit will select this input whilst a stereo-jack is plugged in.

Note: Plugging a source into the front panel Aux input overrides the A1 input. Simply remove the jack from the front panel to automatically re-enable the A1 input.

Note: Also be aware that as the output level of Aux players tends to be quite low, the AXA35 adds 10dB to the current volume setting when (and only when) the Aux input is selected.

5. Input source buttons (A1, A2, A3, A4, Phono) - Press the relevant source button to select the desired input source. The signal selected is also fed to the Rec Out sockets so that it may be recorded. The input should not be changed whilst recording.

Note: There will be no sound from the amp if the correct input source isn't selected.

6. Display - Used to display information such as the selected input source, volume and tone/ balance levels.

Note: When first purchased, the display will have a protective film over the top. Peel this off for a clear display.

7. Menu button - Pressing this once will select the 'bass' option. Pressing a second time will select the 'treble' option, and pressing a third time will select the 'balance' option. When one of these options is selected, the volume control will adjust the level.

If nothing is pressed for a while, the source will be displayed and the volume control will go back to controlling the volume level.

Note: Any adjustments to the bass, treble, and balance settings are saved when the unit is switched off and back on again.

8. Volume control - Use to increase or decrease the level of the sound from the outputs of the unit. This controls the volume level of the loudspeakers and headphones.

The volume control will also change the level of bass, treble and balance in the menu options.

Note: The volume control does not affect the level of the 'Rec Out' output as this has a fixed level.

Rear panel connections

Last updated: July 29, 2022 10:25. Revision #7840

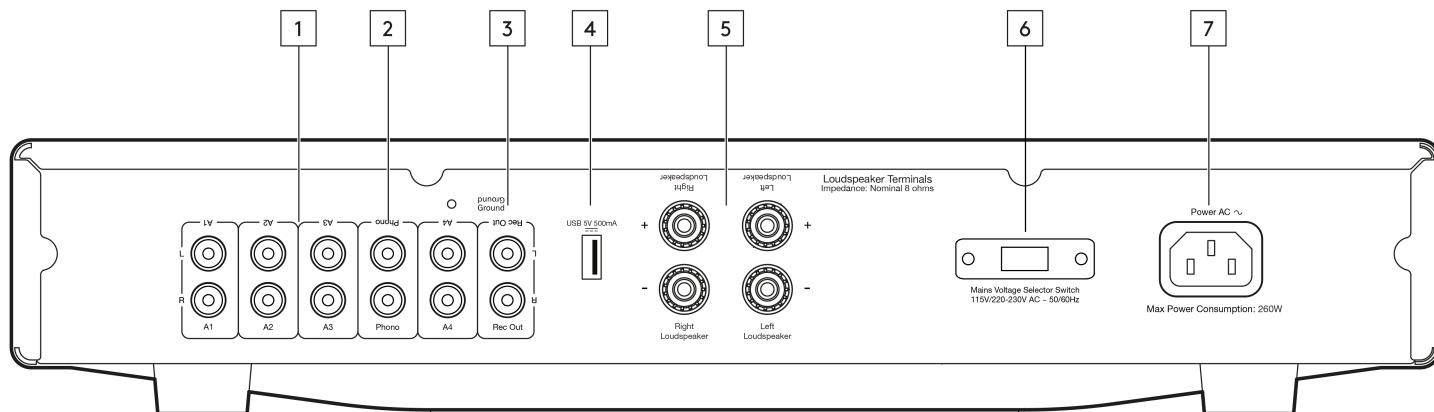

1. Audio inputs (A1-A4) - These inputs are suitable for any 'line level' source equipment such as the audio outputs of CD players, streaming devices such as a Chromecast Audio (RCA Phono to jack cable required) etc.

2. Phono input -

This unit also has a built in Phono stage.

Record players fitted with Phono Cartridges of the Moving Magnet (MM) or high output Moving Coil (MC) type (between 2-6mV output and 30-50k ohms load impedance) can be used.

Low output Moving Coil types (<1mV and usually 10-1000 ohm load impedance) cannot be directly connected and will require a matching transformer or head amp. Please consult your dealer for details.

Note: The 'Ground' terminals on both the record player and the AXA35 should be connected (where possible) with a ground wire for lowest noise/hum pickup.

Due to stray magnetic fields, turntables should not be located in close proximity due to possible interference.

3. Rec out -

Connect to the recording input of a CD recorder, tape deck or other compatible recording device etc.

This output provides a constant high level output that does not fluctuate with the volume of the main unit. For this reason, the AXA35 cannot be used as a Preamp only or with a subwoofer.

4. USB power 5V 500mA -

This USB connection is designed to charge a device, such as a smartphone. The charging device needs to require 5V DC to be able to be charged.

Note: This is **not** an input so will not allow you to play audio directly to the unit.

Note: Do **not** use this port for charging a device *and* using it as a source at the same time, as this will create a ground loop that will cause interference during playback.

5. Loudspeaker terminals - **Note:** When using a banana plug, make sure the speaker terminals are completely tightened before inserting the plug.

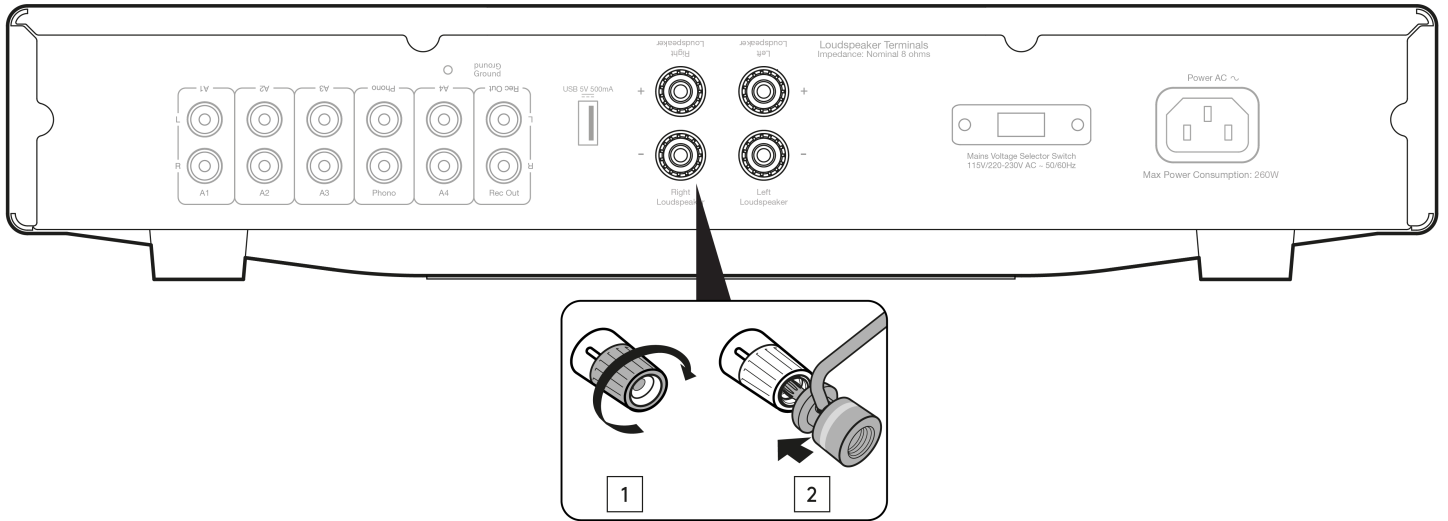

Connect the wires from your left channel loudspeaker to the Left positive and negative terminals and the wires from the right channel loudspeaker to the Right positive and negative terminals.

In each case, the red terminal is the positive output and the black terminal is the negative output.

Care should be taken to ensure no stray strands of wire are accidentally connecting speaker outputs together as this may cause damage to the unit.

Please ensure that the loudspeaker terminals have been tightened adequately to provide a good electrical connection. It is possible for the sound quality to be affected if the screw terminals are loose.

6. Voltage select switch - For servicing use only.

7. AC power socket - Once all connections are complete, plug the AC power cable into an appropriate mains socket and turn the unit on.

Please only use the power lead supplied with the unit.

Remote control

Last updated: August 1, 2022 04:24. Revision #7839

The AXA35 is supplied with a remote control that operates this unit. In addition, some icon buttons can operate a matching AXC35 or AXC25 player.

The supplied AAA batteries must be fitted before the remote control can be used.

1. Power button - Switches the AXA35 between 'on' and low power, eco-friendly 'standby' mode.

2. Mute - Muted audio on the unit. Press again to cancel mute.

3. Volume - Increases or decreases the volume of the unit. Also used to change the bass, treble and balance settings when these are selected.

4. Menu - Toggles between 'bass', 'treble' and 'balance' options. Use the volume buttons to change the level of the selected option.

5. Source buttons (A1, A2, A3, A4, phono) - Press the relevant button to select the desired audio source.

audio source

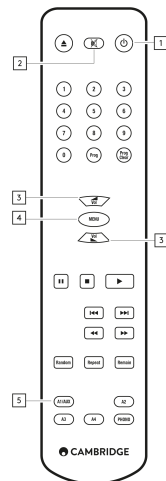

Getting connected

Last updated: July 29, 2022 10:25. Revision #7838

Loudspeakers.

Check the impedance of your speakers. You can use speakers with an impedance of 8 Ohms.

The red coloured speaker terminals are positive (+) and the black speaker terminals are negative (-). Make sure correct polarity is maintained at each speaker connector or the sound can become weak and phased with little bass.

Using bare wire connections.

Prepare the speaker cords for connection by stripping off approximately 10mm (3/8") or less of the outer insulation. More than 10mm could cause a short circuit. Twist the wires tightly together so there are no loose ends. Unscrew the speaker terminal, insert the speaker cable, tighten the terminal and secure the cable.

Note: All connections are made using standard loudspeaker cable.



Using banana plugs.

We recommend using Banana plugs with our units to establish a secure connection and ensure there are no loose strands of wire that may cause unwanted noise or interference. Once you have stripped the outer insulation of the cable and twisted the wires as indicated below, securely connect these to your banana plugs, remove the dust cap from the end of the speaker terminal and push the plug in as far as possible without applying excessive force.

Note: When using a banana plug, make sure the speaker terminals are completely tightened before inserting the plug.

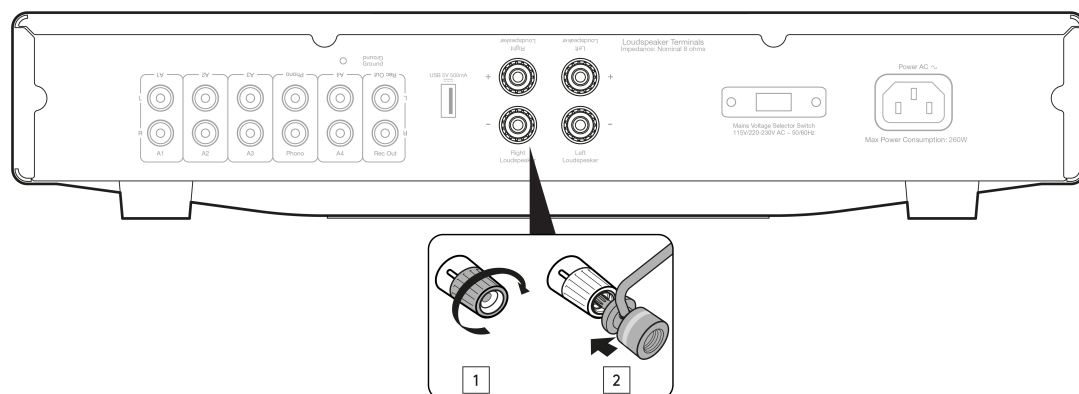

Basic connection.

Any 'line level' source equipment can be connected to the audio inputs on the amplifier (A1 to A4).

The diagram below shows the basic connection of the AXA35 to a CD player using the A1 analogue input and a pair of loudspeakers.

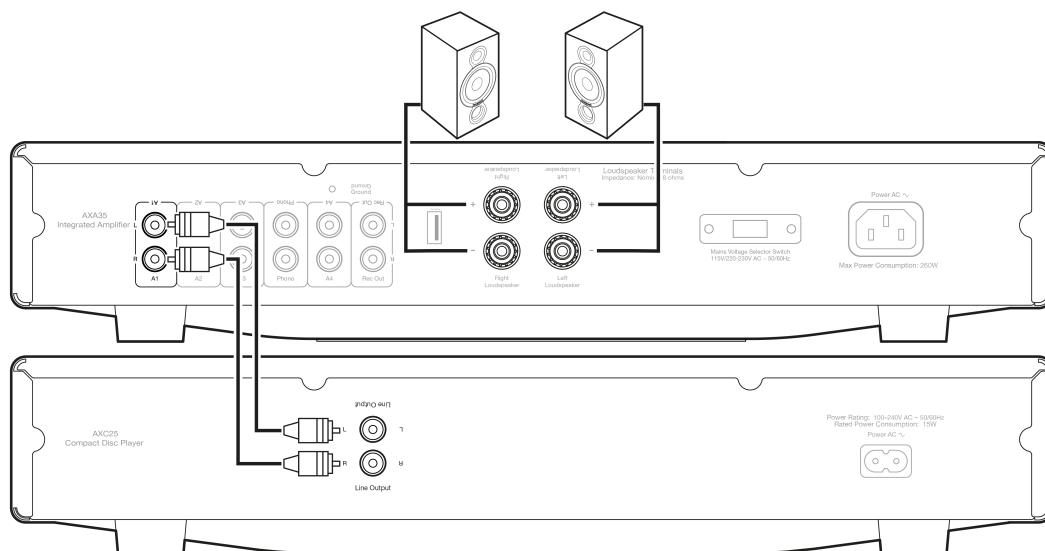

The diagram below shows the basic connection of the AXA35 to a turntable via the Phono input.

This unit has a built-in Phono preamplifier (Phono Stage), so if your turntable does not possess its own Phono Stage, you may connect the record player to the input on the rear of the unit marked 'Phono'.

If your turntable does have a built-in Phono stage or you are using an external version, you should connect to any of the other analogue inputs, as the 'Phono' input may produce an unwanted distortion.

Note: Do **not** connect a non-phono source to the phono input.

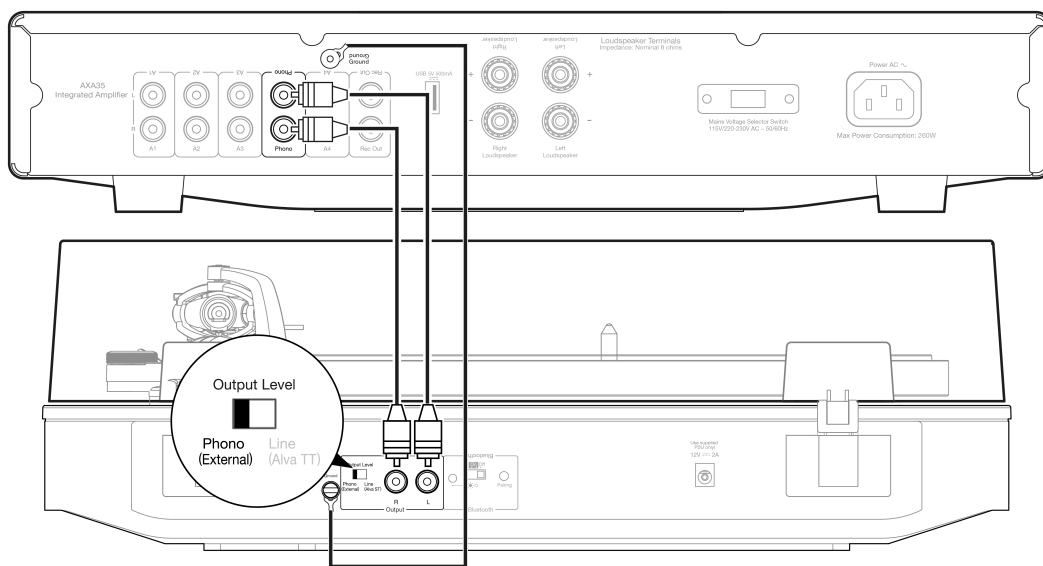

Operating instructions

Last updated: July 29, 2022 10:25. Revision #7837

After making any connections to your unit, activate the AXA35 by pressing the Power button on the front of the unit.

Setting the source.

Press the Source button on the front of the unit corresponding to your desired source. Alternatively, you may use the appropriate button on the remote control.

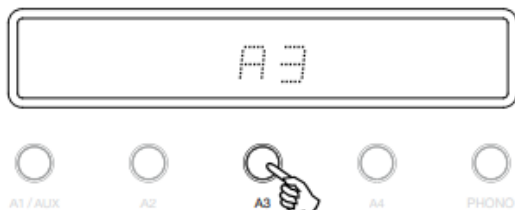

Adjusting the volume.

Use either the Volume Up/Down buttons on the remote control, or the Volume control on the front of your unit system to change the volume level. The newly selected level will be indicated briefly on the front display.

The volume is displayed in minus dB where 0dB is the highest level.

A progressively larger negative number indicates the volume is being reduced.

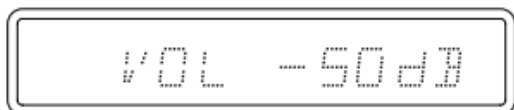

Adjusting the audio settings.

Adjustments to the bass, treble and balance can be made as follows:

1. To enter the audio menu. Press either the Menu button on the front of the unit or on the remote control.
2. Step through the available settings by pressing the Menu button. The settings available are in order Bass, Treble and Balance.

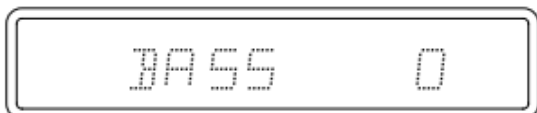

3. When you wish to make an adjustment for bass, treble or balance, simply rotate the Volume control or use the Volume control buttons on the remote control.

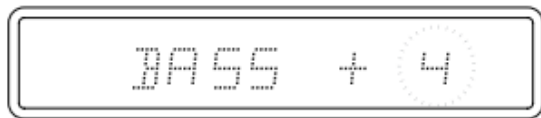

4. To exit, wait for five seconds until the unit returns to normal mode.

Technical specifications

Last updated: July 29, 2022 10:25. Revision #7836

Power Output

35 watts (into 8Ω)

THD (unweighted)

<0.01% @ 1kHz, 80% of rated power

Frequency response (-3dB)

5Hz - 50kHz

S/N ratio (ref 1W)

>82dB (unweighted)

Input impedances

47k ohms

Power Amp damping factor

>50

Max. power consumption

260W

Bass/Treble controls

Shelving, ultimate boost/cut +/- 10dB @ 100Hz and 10kHz

Standby power consumption

<0.5W

Inputs

4x RCA, 1x Phono, 1 x 3.5mm Aux input (front panel)

Outputs

Speakers, Rec Out, USB 5V power

Dimensions (HxWxD)

83 x 430 x 335mm (3.3 x 16.9 x 13.2")

Weight

5.6kg (12.3lbs)

Troubleshooting

Last updated: July 29, 2022 10:25. Revision #7835

There is no power.

- Ensure the AC power cord is connected securely.
- Ensure the plug is fully inserted into the wall socket and is switched on.
- Check fuse in the mains plug or adaptor.
- Check the power button is on at the front of the unit.

There is no sound.

- Check the correct input is selected on the front panel of the amplifier.
- Check that the speakers are connected correctly.
- Check that the unit is not in mute mode.

The sound is distorted.

- Check speaker connections.
- Ensure that any non-phono source is **NOT** connected to the phono input.

There is a hum coming from the speaker.

- Ensure that all cable connections are secure, particularly ground/shield connections for turntables.

There is unwanted background noise and interference.

- Move the unit away from other electrical equipment that is likely to cause interference.
- Ensure that all cable connections are secure, particularly ground/shield connections for turntables.
- Ensure that you are **not** charging a device via the USB port *and* using it as an audio source at the same time.

The remote handset will not function.

- Check that the batteries are the correct way around and have not expired.
- Ensure that nothing is blocking the remote sensor.

Frequently Asked Questions (FAQ)

Last updated: July 29, 2022 10:25. Revision #7844

Why doesn't the AXA35's USB connection produce any sound?

The USB input on the rear of the AXA35 is not designed as an audio input. This is purely for charging devices and maintaining power to components such as a Streaming device.

Can I insert a Bluetooth adaptor in to the AXA35's USB port to enable Bluetooth functionality?

The USB port on the rear of the AXA35 is only designed for charging a device, such as a smart phone. It is, therefore, not possible to insert a Bluetooth adaptor in to this port to enable Bluetooth functionality with the AXA35.

Can I use 4 or 6 Ohm speakers with the AXA35?

The AXA35 is only rated to be used with 8 Ohm speakers and we would not recommend using it with 4 or 6 Ohm speakers.

Using the AXA35 with 4 or 6 Ohm speakers could result in the amplifier overheating, which in the long run could damage the unit.