



McIntosh Laboratory, Inc. 2 Chambers Street Binghamton, New York 13903-2699 Phone: 607-723-3512 www.mcintoshlabs.com

MS500

Music Streamer

Owner's Manual





Important Safety Information is supplied in a separate document “Important Additional Operation Information Guide”

Thank You

Your decision to own this McIntosh MS500 Music Streamer ranks you at the very top among discriminating music listeners. You now have the best. The McIntosh dedication to precision performance assures many years of musical enjoyment.

Please take a short time to read the information in this guide. We want you to be as familiar as possible with all the features and functions of your new McIntosh.

Please Take A Moment

The serial number, purchase date and McIntosh Dealer name are important to you for possible insurance claim or future service. The spaces below have been provided for you to record that information:

Serial Number: _____

Purchase Date: _____

Dealer Name: _____

Technical Assistance

If at any time you have questions about your McIntosh product, contact your McIntosh Dealer who is familiar with your McIntosh equipment and any other brands that may be part of your system. If you or your Dealer wish additional help concerning a suspected problem, you can receive technical assistance for all McIntosh products at:

McIntosh Laboratory, Inc.
2 Chambers Street
Binghamton, New York 13903
Phone: 607-723-3512
Fax: 607-724-0549

Copyright 2017 © by McIntosh Laboratory, Inc.

Customer Service

If it is determined that your McIntosh product is in need of repair, you can return it to your Dealer. You can also return it to the McIntosh Laboratory Service Department. For assistance on factory repair return procedure, contact the McIntosh Service Department at:

McIntosh Laboratory, Inc.
2 Chambers Street
Binghamton, New York 13903
Phone: 607-723-3515
Fax: 607-723-1917

Table of Contents

Safety Instructions	2
(Separate Sheet)	Important Additional Operation Information Guide
Thank You and Please Take a Moment.....	2
Technical Assistance and Customer Service	2
Table of Contents	2
Trademark and License Information	2
General Information	3
Connector and Cable Information	3
Introduction.....	4
Performance Features	4
Dimensions	5
Installation	6
Rear Panel Connections	7
AC/DC Adapter	8
MS500 Connections.....	10-11
Front Panel Display and Push-button.....	12
How to use the Remote Control.....	13
How to Operate the Setup Mode	14-15
How to Operate the MS500	16-23
Photos.....	25
Specifications.....	26
Packing Instructions	27

Trademark and License Information

The McIntosh MS500 incorporates copyright protection technology that is protected by U.S. patents and other intellectual property rights.

General Information

- For additional connection information, refer to the owner's manual(s) for any component(s) connected to the MS500 Music Streamer.
- When the MS500 Music Streamer is connected to an audio system, playback of music already stored on it may be listened to. To take full advantage of the many features the MS500 is capable of, such as importing and storing additional music on the Music Streamer, requires connection to a Computer Network System.
- For best performance, the speed of the Computer Network the MS500 Music Streamer would be connected to should be 1 Gigabit or faster.
- The MS500 internal Digital to Analog Converter Circuitry is designed to decode 2-channel PCM (Pulse Code Modulation) Digital Signals up to 24Bit 192kHz. The Digital Output Signal present at the Coaxial and Optical Output Connectors is a 2-channel PCM (Pulse Code Modulation).
- The MS500 is designed to be compatible with the majority of Audio Power Amplifiers. However, do to a wide range of Power Amplifier Designs, it is important the input sensitivity of the amplifier be at least 2 Volts. This will assure the playback of most music recordings are reproduced with adequate dynamic range. Check with your McIntosh Dealer for additional information.
- The IR Input, with a 3.5mm mini phone jack, is configured for non-McIntosh IR sensors such as a Xantech Model DL85K Kit. Use a Connection Block, such as a Xantech Model ZC21, when two or more IR sensors need to be connected to the MS500.
- When discarding the unit, comply with local rules or regulations. Batteries should never be thrown away or incinerated but disposed of in accordance with the local regulations



concerning battery disposal.

- If it should become necessary to replace the supplied AC / DC Power Adapter, order part number 32059900 from the McIntosh Parts Department.
- For additional information on other McIntosh Products please visit the McIntosh Web Site at www.mcintoshlabs.com.
- Mobile Device Apps for remote control operation of the MS500, are available. Go to the McIntosh Web Site at <http://www.mcintoshlabs.com/us/Support/Pages/Manuals.aspx> Under "PRODUCT CATEGORY" select "Media Streamers" then under "MODEL NUMBER" select "MS500". Click on "SEARCH" then click on the MS500 Music Streamer App (iPhone, iPad or Android) for your mobile device.

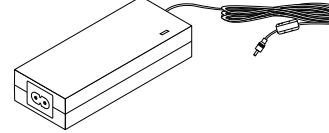

Connector and Cable Information

XLR Connectors

Below is the Pin configuration for the XLR Balanced Output Connectors on the MS500. Refer to the diagram for connection:

- PIN 1: Shield/Ground
- PIN 2: + Output
- PIN 3: - Output

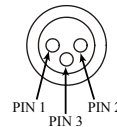

Data and IR Input Port Connectors

The MS500 Data In Port receives Remote Control Signals. A 3.5mm stereo mini phone plug is used for connection. The IR Ports also use a 3.5mm stereo mini

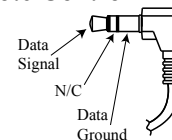

phone plug and allow the connection of other brand IR Receivers to the MS500.

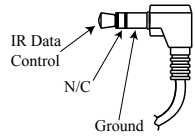

Power Control Connector

The Power Control Input Jack receives Power On/Off Signals (+12 volt/0 volt) when connected to other McIntosh Components. The Power Control Output Jack sends Power On/Off Signals (+12 volt/0 volt) when connected to other McIntosh Components. An additional connection is for controlling the illumination of the Power Output Meters on McIntosh Power Amplifiers. A 3.5mm stereo mini phone plug is used for connection to the Power Control Jacks.

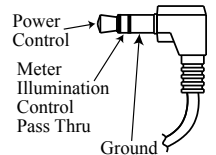

Ethernet RJ45 Socket

- Transmit Data (+)
- Transmit Data (-)
- Receive Data (+)
- N/C
- N/C
- Receive Data (-)
- N/C
- N/C

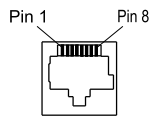

Ethernet Cable - Straight Thru Connections

Pin Number - Wire Color	Pin Number - Wire Color
1. Orange/White	1. Orange/White
2. Orange	2. Orange
3. Green/White	3. Green/White
4. Blue	4. Blue
5. Blue/White	5. Blue/White
6. Green	6. Green
7. Brown/White	7. Brown/White
8. Brown	8. Brown





Introduction

The McIntosh MS500 Music Streamer offers the latest in audio technology, providing state of the art audio reproduction with the convenience of instant access to your music library. When the MS500 is added to a McIntosh System, the music from this source may be enjoyed in your home. The advanced design ensures many years of smooth trouble free operation.

Performance Features

• Built-in Networking Capability

The MS500 has the ability to connect to an existing network for connecting to other devices also connected to the network, including the Internet (the Cloud).

• High Storage Capacity

The MS500 incorporates a massive 500 Gigabyte Hard Drive capable of storing the contents of a large Music Collection.

• Expand the Music Server System

The MS500 can provide seamless access to music contained on other MS500(s) from different physical locations. It can also access music stored on other devices such as Computers and NAS (Network Assisted Storage) Devices connected to the same network as the MS500. This provides for unlimited music storage capacity.

• USB 3 and USB 2 Inputs

Connect external storage devices to the MS500 for increased music storage capacity.

• Internet Streaming Services

The MS500 also allows for listening to Internet Stations when connected.

• Local AM/FM Radio Stations

The MS500 also allows for listening to AM/FM Stations via the Internet Connection.

• Select your Music

Listen to the music you want by creating your own play lists and/or groups of music types.

• Digital Audio Outputs

There is a Coaxial and an Optical Digital Audio Output (SPDIF) for connection to other components.

• Balanced and Unbalanced Analog Outputs

The MS500 has both Unbalanced Outputs and Balanced Outputs which permit long cable lengths without a loss in sound quality.

• Graphical User Interface

When connected to a TV/Monitor, the On Screen Display provides information such as Album Name, Artist Name, Song Name, Playing Time and Location for each of the selections. This allows for easy song selection from multiple rooms in your home.

• HD Video Outputs

The MS500 has HDMI and VGA Connections for providing High Definition Video Signals of 1080p or 720p resolutions.

• On Screen Setup

The On Screen Setup allows for customizing various settings such as audio, video, network and external control to match the components in your system.

• Quiet Fan Less Operation

Enjoy your music even at low system volume settings.

• Power Control

The Power Control Input connection provides convenient Turn-On/Off of the MS500 when connected to a McIntosh System with Power Control.

• Remote Control

The Remote Control with illuminated push-buttons, provides control of the MS500 operating functions. A Data Port Connection to a McIntosh A/V Processor or Preamplifier allows for convenient system operation using one Remote Control. An External IR Sensor Input allows for remote operation when the MS500 is located behind closed doors.

• Illuminated Glass Front Panel

The famous McIntosh Glass Front Panel is evenly illuminated by multiple extra long life Light Emitting Diodes (LEDs), arranged with a special orientation. The pristine beauty of the MS500 will be retained for many years.

Dimensions

The following dimensions can assist in determining the best location for your MS500.

Front View of the MS500

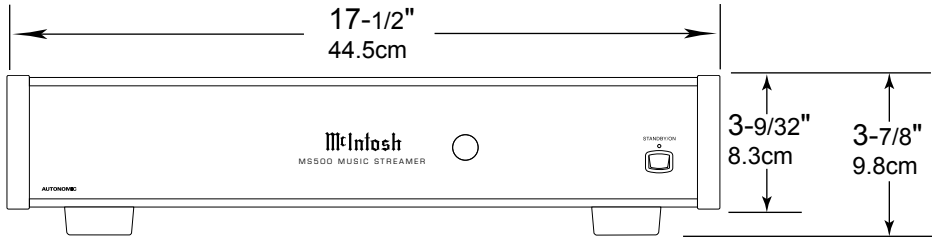

Side View of the MS500

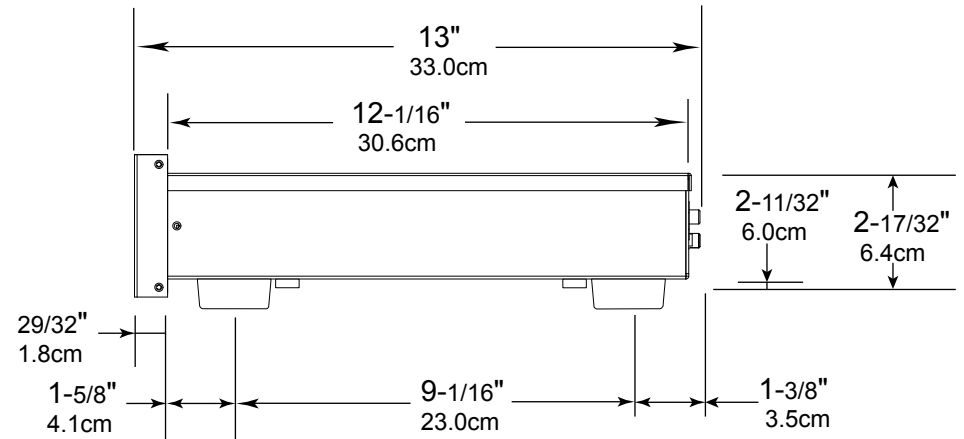

Rear View of the MS500

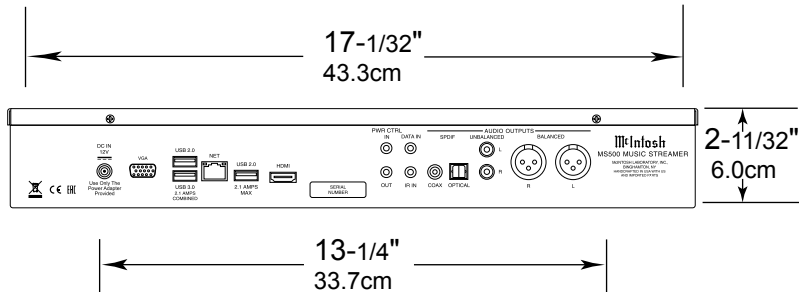

Installation

The MS500 can be placed upright on a table or shelf, standing on its four feet. It also can be custom installed in a piece of furniture or cabinet of your choice. The four feet may be removed from the bottom of the MS500 when it is custom installed as outlined below. The four feet together with the mounting screws should be retained for possible future use if the MS500 is removed from the custom installation and used free standing. The required panel cutout, ventilation cutout and unit dimensions are shown.

Always provide adequate ventilation for your MS500. Cool operation ensures the longest possible operating life for any electronic instrument. Do not install the MS500 directly above a heat generating component such as a high powered amplifier. If all the components are installed in a single cabinet, a quiet running ventilation fan can be a definite asset in maintaining all the system components at the coolest possible operating temperature.

A custom cabinet installation should provide the following minimum spacing dimensions for cool operation.

Allow at least 3 inches (7.6cm) above the top, 2 inches (5.1cm) below the bottom and 1 inch (2.5cm) on each side of the Music Streamer, so that airflow is not obstructed. Allow 17 inches (43.2cm) depth behind the front panel. Allow 29/32 of an inch (1.8cm) in front of the front panel for clearance. Do not block the openings on the top cover or the three rows of louvers opening on the bottom of the MS500. Be sure to cut out a ventilation hole in the mounting shelf according to the dimensions in the drawing.

**MS500 Front Panel
Custom Cabinet Cutout**

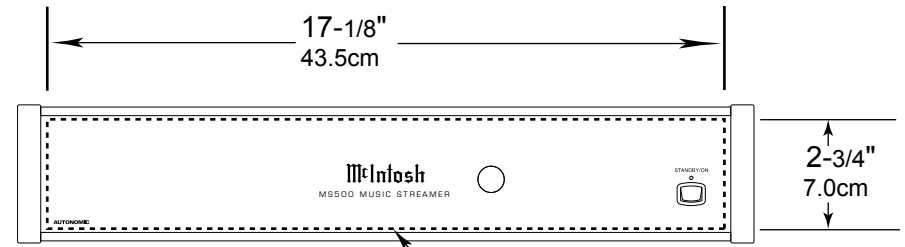

**MS500 Side View
in Custom Cabinet**

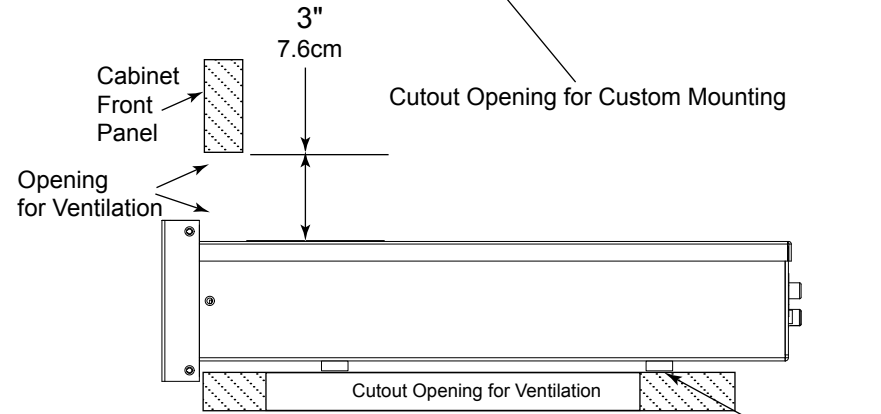

**MS500 Bottom View
in Custom Cabinet**

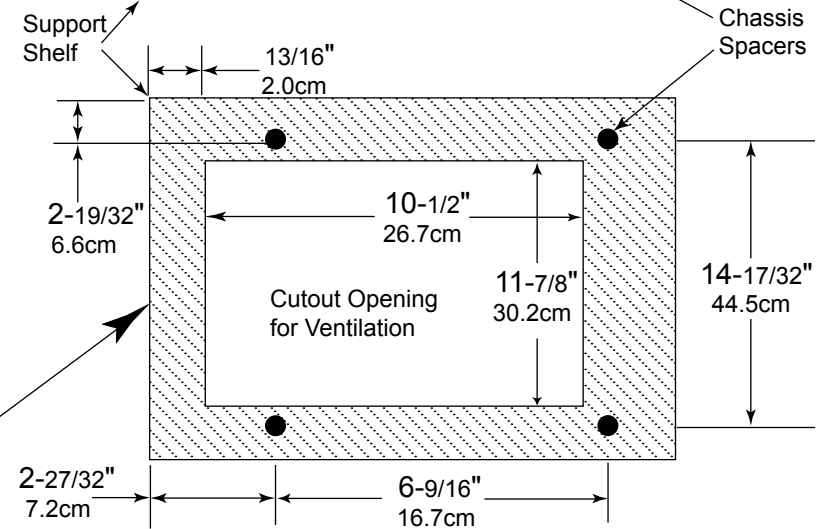

Note: Center the cutout horizontally on the unit.
For purposes of clarity, the above illustration is not drawn to scale.

Rear Panel Connections

Connect the supplied AC/DC Power Adapter DC Output Connector

HDMI (High-Definition Multimedia Interface) Output (Audio and Video Digital Signals) for connecting to a HDTV or Monitor with a HDMI Input with a video resolution 720p or 1080p

DATA IN receives control data from a McIntosh Control Center

BALANCED AUDIO OUTPUTS supply analog audio signals to connect to Balanced Inputs of other components

USB (version 2.0)¹ for connection of an external storage device capable of transferring data

PWR CTRL (Power Control) IN receives turn-on signals from a McIntosh component and POWER CONTROL OUT sends turn-on signals on to another McIntosh Component

COAXial and OPTICAL AUDIO OUTPUTS send a Digital Audio Signal to a Preamplifier or an A/V Control Center with a D/A Converter or a decoder

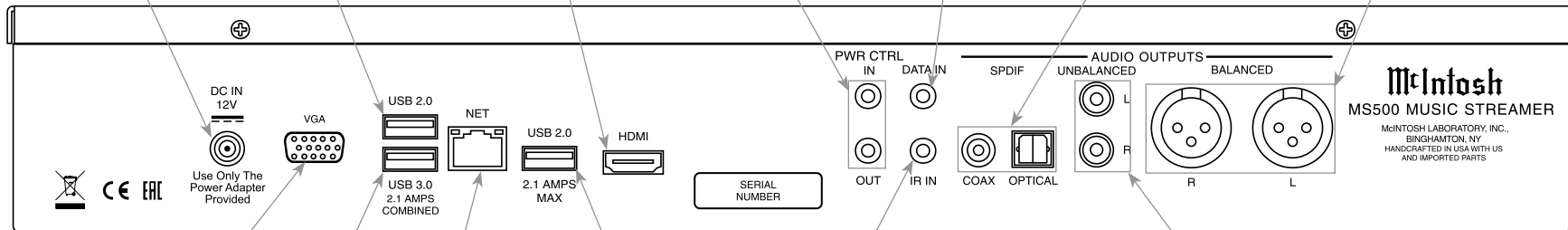

VGA (Video Graphics Array) Analog Video Output for connecting to a TV or Monitor with a VGA Input

NETwork Connector for connecting the MS500 to a Broadband Ethernet Network

IR IN for connecting an IR Receiver

UNBALANCED AUDIO OUTPUTS supply analog audio signals to Unbalanced Inputs of other components

USB (version 3.0)¹ for connection of an external storage device capable of transferring data at high speed

USB (version 2.0)¹ for connection of an external storage device capable of transferring data

¹ One at a time, of the three USB Connectors on the MS500 has the ability to output Digital Audio Signal for music playback to an external audio device compatible with USB current operational standards

The AC/DC Power Adapter supplied with the MS500 Music Streamer

AC/DC Adapter power On LED Indicator

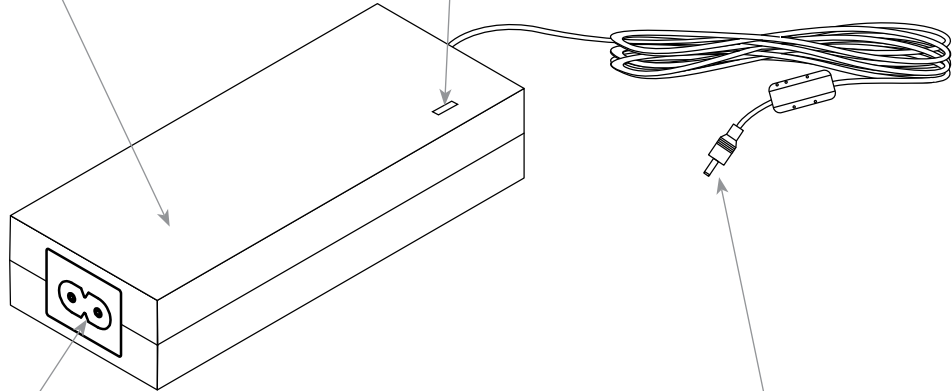

Connect to a live AC outlet (always On) using the supplied AC Power Cord. Refer to information on the power supply to determine the correct voltage.

Connect to the DC IN connector on the Rear Panel of the MS500 Music Streamer







MS500 Connections

The MS500 has the ability to be remotely switched On/Off from a McIntosh Preamplifier or A/V Processor via the Power Control connection. The MS500 Data Port Connection allows for the remote operation of basic functions using the Preamplifier, Integrated Amplifier or A/V Control Center Remote Control. With an external sensor connected to the MS500, remote control operation is possible from another room and/or when the MS500 is located in a cabinet with the doors closed.

The connection instructions below together with the MS500 Connection Diagram on the next page is an example of a typical audio or audio/video system. Your system may vary from this, however the actual components would be connected in a similar manner. For additional information refer to “Connector and Cable Information” on page 3.

Power Control Connections:

1. Connect a Control Cable from the Preamplifier, Integrated Amplifier or A/V Processor Power Control MAIN (or ACC) Jack to the PWR CTRL (Power Control) IN Jack on the McIntosh MS500 Music Streamer.
2. Optionally, connect a Control Cable from the MS500 Music Streamer PWR CTRL OUT Jack to another component.
3. Connect any additional components in a similar manner, as outlined in steps 1 thru 3.

Data Control Connections:

4. Connect a Control Cable from the Preamplifier, Integrated Amplifier or A/V Processor Data Port 1 Jack to the McIntosh MS500 Music Streamer DATA IN Jack.

Sensor Connections:

5. Optionally, connect an IR Sensor to the McIntosh MS500 Music Streamer IR IN Jack.

Digital Audio Connections:

6. Optionally, connect a Cable from the McIntosh MS500 Music Streamer AUDIO OUTPUT SPDIF OPTICAL Output to the Digital Audio Input Optical 1 Input on the Preamplifier, Integrated Amplifier or A/V Processor.

Note: Coaxial connections may be used instead of the Optical Connections.

Analog Audio Connections:

7. Connect a Cable from the McIntosh MS500 Music Streamer AUDIO OUTPUT BALANCED connectors to the Preamplifier, Integrated Amplifier or A/V Processor Balanced 1 Input connectors.

Note: Unbalanced connections may be used instead of the Balanced Connections.

Digital Video Connections:

8. Connect a HDMI Cable between the HDMI Socket on the Rear Panel of the MS500 Music Streamer to a HDMI Input Socket on the HD Monitor/TV.

Notes: 1. If the Monitor/TV has a VGA Input and no HDMI input, then connect a VGA cable between the MS500 and the Monitor/TV.

2. The MS500 HDMI Output Socket provides Video Signals only. For Audio Signal Playback, perform connections in step 6 or 7.

Network Connections:

9. Using a CAT 5/6 Ethernet Cable, connect the cable from the Router to the NET (Network) connector on the Rear Panel of the MS500.
10. Optionally, connect another CAT 5/6 Ethernet Cable from the Computer (Network Connector) to the Router.

Note: For additional information on Networks and Network Connections refer to the documentation supplied with the Router and Computer.

AC Power Cords Connections:

11. Locate the plug at the end of the cable coming out of the supplied AC/DC Power Supply and connect it to the DC Input connector on the Rear Panel of the MS500 Music Streamer.
12. Connect the supplied AC Power Cord between the socket on the AC/DC Power Supply and a live AC outlet (that is always On).

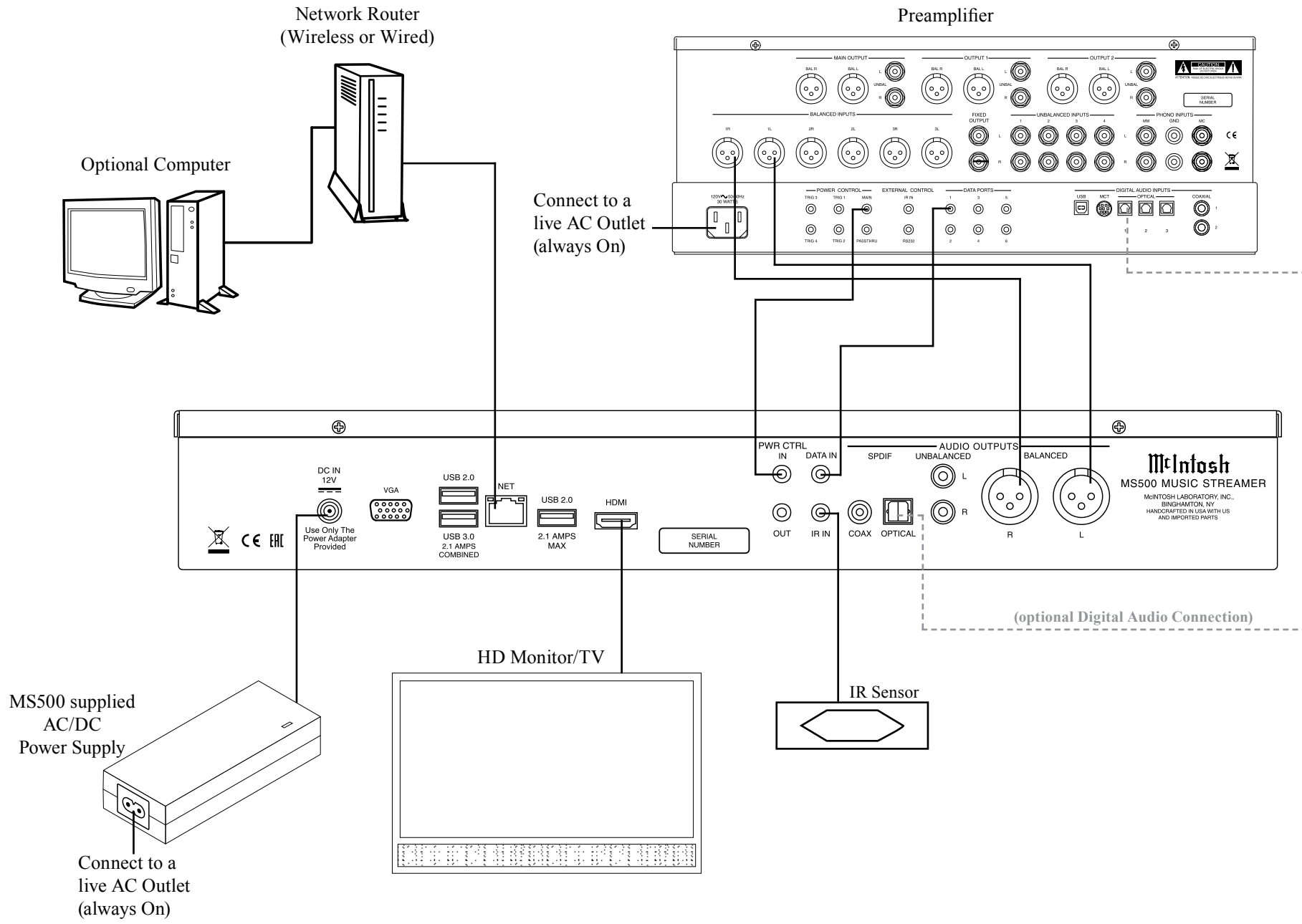

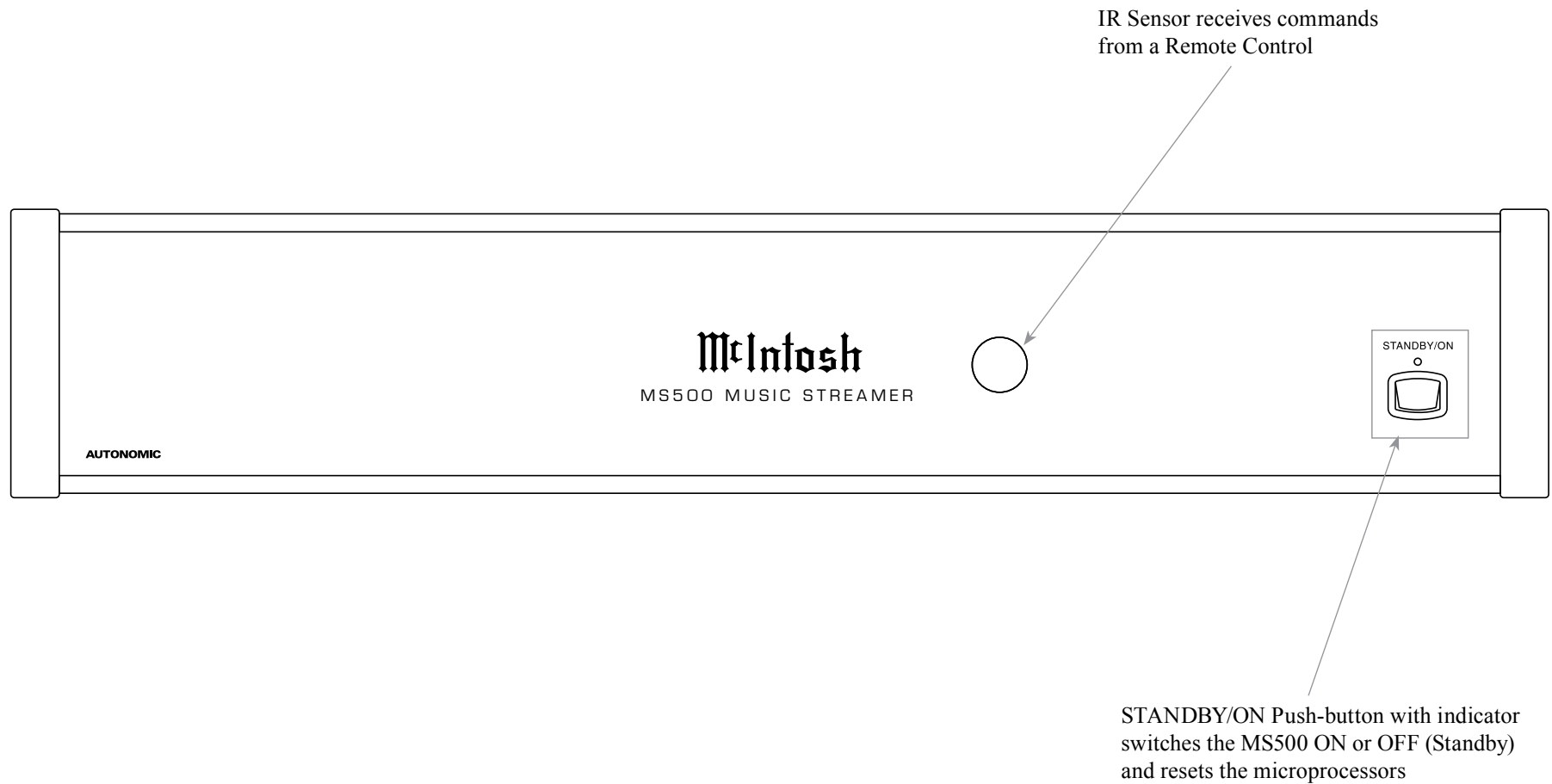

How to use the Remote Control

The Remote Control is capable of performing most Operating Functions for the MS500 Music Streamer.

Note: Refer to the "How to Operate" Section of this manual for additional information using this Remote Control.

Dual Function Push-buttons

The five push-buttons located at the top/front of the Remote Control, in the circular molded area, are dual function. When music is playing, the (+) Push-button increases the volume level¹ and the (-) Push-button decreases the volume level¹. Push the ►► Push-button for the next selection or push the ◀◀ Push-button for the previous selection.

During the time a MS500 Menu is being accessed, the push-buttons at the top/front of the Remote Control provide the ability to navigate the menus and select the desired choice or function. The (+) Push-button is used to move the cursor Up through the menu. Likewise, the (-) Push-button is used to move Down. The ◀◀ Push-button is used to move to the Left, the ►► Push-button is used to move to the Right and the ►|| Push-button is used to Select the highlighted choice.

SELECTS the current menu item and also starts playback and pauses playback

Directional Push-buttons; + (Up), - (Down), ◀◀ (Left), ►► (Right) and ►|| (SELECTS)

Increases the volume level

Selects the next selection

Momentarily press to Power the MS500 ON or OFF

Indicates when a Remote Control Command has been sent

Current selection is disliked

Selects available information

Moves forward in time through a selection

Selects the previous selection

Decreases the volume level

Current selection is liked

Selects a Menu

Reserved for future use

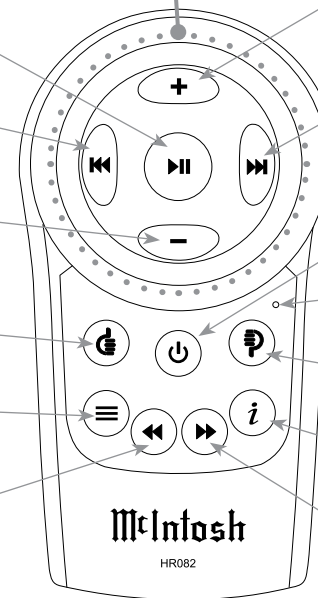

¹Adjusting the volume level using the Remote Control requires a change to the default setting located in the Setup Mode, refer to pages 14 and 15 for additional information.

Each of the tabs has subheadings with current settings status information along with various setup options. There are explanations located to the right of the various options and settings.

4. Select “Display Settings”. Refer to figure S2.
5. To change the “Screen Resolution” from the default setting of 720p to 1080p, click on the circle ahead of “1080p 1920x1080”.
6. To implement the Setup change just made, Click on the Display Settings Button “Save Changes”. Then press the MS500 Front Panel STANDBY/ON Push-button or press the **⏻** (Power) Push-button on the Remote Control to switch OFF the MS500.
7. Press the Front Panel STANDBY/ON Push-button or press the **⏻** (Power) Push-button on the Remote Control to switch ON the MS500.
8. After any other changes have been made and saved, proceed to “How to Operate” starting on page 16.

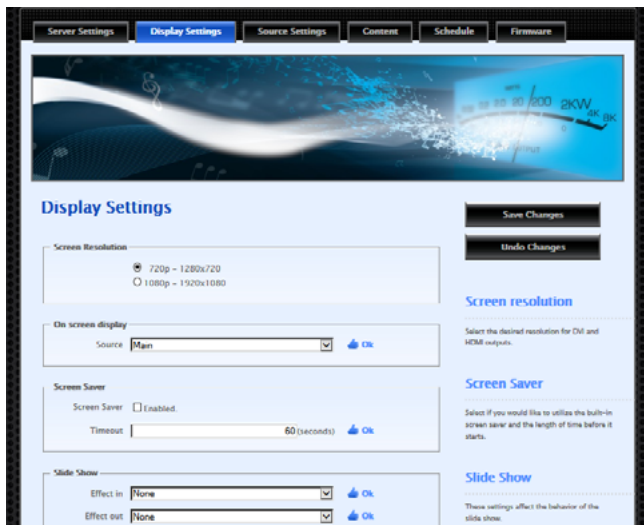

Figure S2



Figure S3

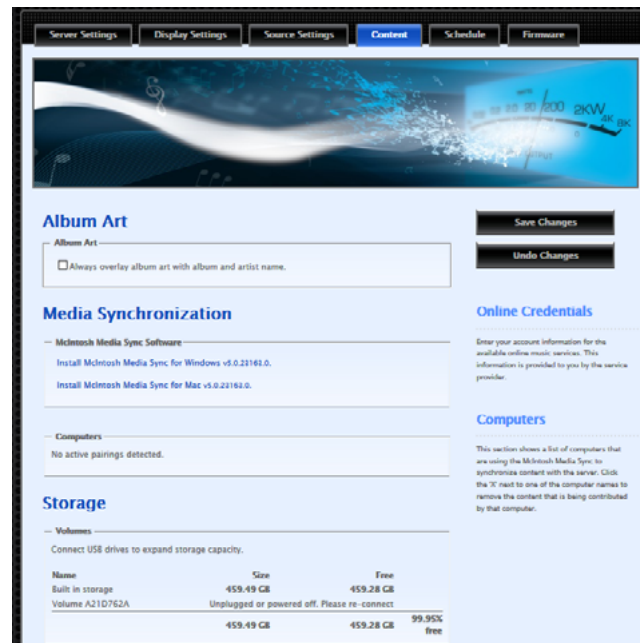

Figure S4

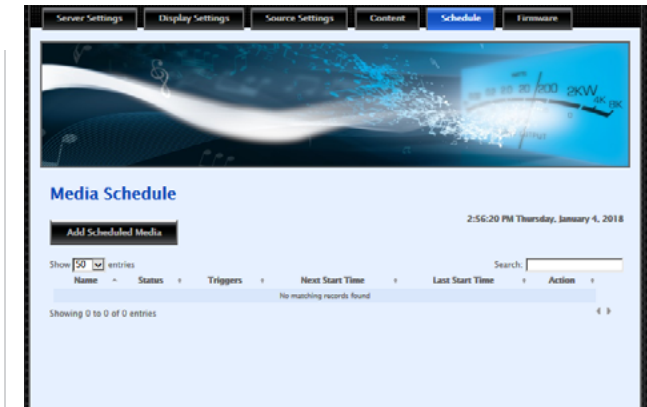

Figure S5



Figure S6

How to Operate the MS500

Power On and Off

Your McIntosh MS500 has been factory configured for default operating settings that will allow immediate enjoyment of superb audio without the need for further adjustments. To make changes to the default settings, refer to the Setup Mode on page 14.

1. Press the STANDBY/ON Push-button on the Front Panel or press the (Power) Push-button on the Remote Control to switch On the MS500. Refer to figures 5, 6 and 7.

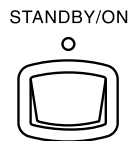

Figure 5

The LED above the STANDBY/ON Push-button will start flashing during the MS500 startup initialization process, which might take upwards

of 30 seconds. The HD Monitor/TV connected to the MS500 will indicate the startup initialization procedure progress. Refer to figures 8, 9 and 10.

2. To switch Off the MS500, press the STANDBY/ON Push-button on the Front Panel or press the (Power) Push-button on the Remote Control. Refer to figures 5 and 6.



Figure 6



Figure 7



Figure 8



Figure 9

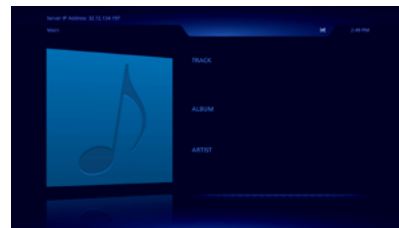

Figure 10

Start Music Playback

Music was imported into the MS500 Music Streamer, at the factory, for your enjoyment. To start listening to the music, perform the following:

1. Press the (MENU) Push-button on the Remote Control to select the Operation Menu. Then using

the (Down) Push-button on the Remote Control, select the “Music Menu” followed by pressing the (SELECT) Push-button to select “Album Menu”. Refer to figures 11 and 12.

2. Press the (SELECT) Push-button on the Remote Control to view the available Albums. Refer to figure 13.

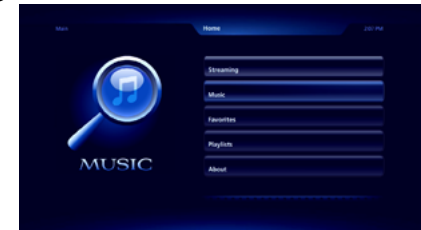

Figure 11



Figure 12



Figure 13

3. Use the (Up) or (Down) Push-button on the Remote Control to select the desired album. In this instance, select “Various Artists - Beethoven: Symphonies Nos. 5 & 9 Choral; Piano Concert”. Then press the (SELECT) Push-button to select the album. Refer to figure 14.



Figure 14

- Referring to figure 15, the track for the album just selected will appear. In this instance there is one track “Symphony No. 9 (Scherzo)”. Press the ►|| (SELECT) Push-button on the Remote Control to start playback of the first track. Refer to figure 16.



Figure 15



Figure 16

The TV/Monitor will start to display various scenes while the music is playing. Refer to figures 17 and 18.

- To pause playback of the music, press the ►|| (SELECT) Push-button on the Remote Control. To resume playback, just press the same Push-button again. To see the status of the track currently playing, press the ⊞ MENU Push-button and refer to information located at the bottom of the screen. Refer to figure 15 and 16.

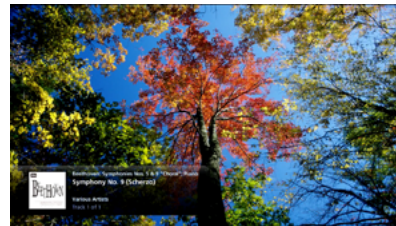

Figure 17



Figure 18

How to Stream Music

The MS500 Music Streamer provides access to virtually unlimited music by streaming music from the Internet. To start streaming music from the Internet, perform the following:

- Press the ⊞ (MENU) Push-button on the Remote Control to select the Home Menu. Refer to figure 19.



Figure 19

- Press the ►|| (SELECTS) Push-button on the Remote Control to select the “Streaming Menu”. Refer to figure 20.



Figure 20

There are many pre-setup Internet Radio Sites to choose from, including Deezer, Murfie, Pandora Internet Radio, Spotify, TIDAL, etc. Some Internet Radio Sites require registering and in some instances a subscription fee in order to enjoy their music services. Using the MS500 Setup Mode on pages 14 and 15, refer to the Contents tab and then the Online Credentials for additional information. In the following example, TuneIn Radio will be selected to stream music from local FM/AM radio stations.

- Using the + (Up) or - (Down) Push-button on the Remote Control, select TuneIn Radio from the menu. Refer to figure 21.

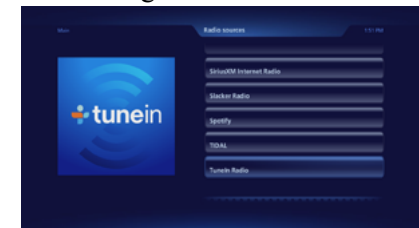

Figure 21

- Refer to figure 22 on the next page, then press the ►|| (SELECTS) Push-button to select Local Radio.

How to Operate the MS500, con't

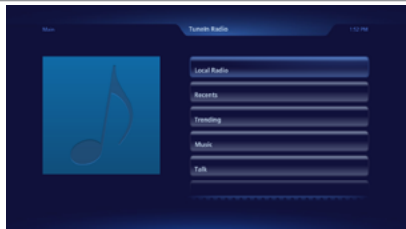

Figure 22

5. There are now menu choices AM, FM or Internet only radio stations. Referring to figure 23, use the + (Up) or - (Down) Push-button to select FM, followed by pressing the the ►|| (SELECTS) Push-button.

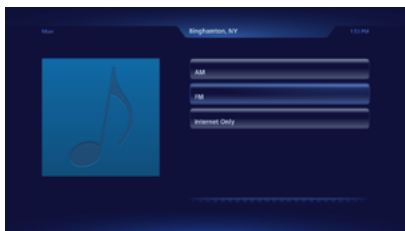

Figure 23

6. Referring to figure 24, it follows the same procedure as in step 5, select the fourth choice, "89.3 WSKG-FM (Classical Music)". The sound from the station will start, refer to figure 25.



Figure 24



Figure 25

How to Operate the MS500 via a Computer

After the MS500 has powered up and completed initialization, the IP Address assigned to the Music Streamer will appear in the upper left corner. Refer to figure 26.



Figure 26

- Using a computer connected to the same network as the MS500, launch an Internet Web Browser Application (such as Windows Internet Explorer). Type in on the "URL-Address line" the following:

The IP Address Number

HTTP:// /MediaBridge

- A connection progress indicator will appear in the Web Browser. Refer to figure 27.
- When the connecting process is completed, the-Music Streamer interface will appear in the Web Browser. Refer to figure 28.

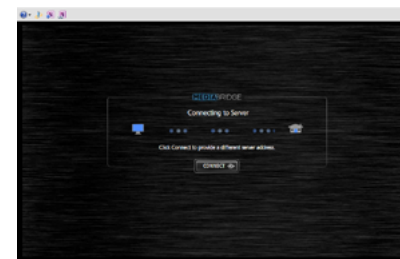

Figure 27



Figure 28

Note: The operation of the MS500 using the Web Browser is similar to using the MS500 connected to a monitor/TV along with the supplied Remote Control. The major difference is the computer pointing device (mouse) is used for selection and navigation.

On the left side is a column of buttons for selecting music sources (Streaming, Local Music, Favorites, Playlists and Queue) along with Back and Next control commands. Along the bottom are buttons for standard control functions such as Previous, Play, Pause, Next, Shuffle and Replay.

How to Playback Music

McIntosh Music was imported into the MS500, at the factory, for your enjoyment. To start listening to the music, perform the following:

1. Click on the Local Music button. Refer to figure 28.
2. Click on “Albums”, then select “Beethoven”. Refer to figure 29.



Figure 29

3. Click on the track listing of “1 Symphony No. 9 (Scherzo) 1:15” and click on “Play now”. Refer to figures 29 and 30.



Figure 30

4. Return to the previous menu selection of “Play now, Play next, Replace queue, Add to queue or Add to playlist” by clicking on the Track (Name) currently playing.

How to Stream Music

The MS500 Music Streamer provides access to virtually unlimited music by streaming music from the Internet. To start streaming music from the Internet, perform the following:

1. Click on the Streaming button and the Radio sources menu will appear. Refer to figure 31.



Figure 31

In the following example TuneIn Radio will be selected to stream music from local FM/AM radio stations.

2. Select and click on TuneIn Radio. Click on Local Radio followed by selecting FM. Refer to figures 32 and 33.



Figure 32



Figure 33

3. Referring to figure 34, select the second choice, “89.3 WSKG-FM (classical)”. The sound from the station will start and figure 35 will appear.



Figure 34



Figure 35

How to Operate the MS500, con't

Using External Drives with the MS500

The MS500 has three different uses for connected External Drives “ADD, IMPORT or MOUNT”. Before proceeding with the steps below, switch power Off to the MS500. Then connect the External Drive (HDD, SDD or USB Flash Memory) to an USB connector on the Rear Panel of the MS500. After the MS500 has powered up and completed initialization, note the IP Address in the upper left corner.

- Using a computer connected to the same network as the MS500, launch an Internet Web Browser Application (such as Windows Internet Explorer). Type in on the “URL-Address line” the following:

The IP Address Number

HTTP:// /config

- Then press enter on the computer keyboard. Refer to figure 36 (partial view).



Figure 36 (partial view)

- Click on the “Content” Tab (located along the top), then scroll down to “Storage”. Referring to figure 37, the three options for the external USB Connected Drive appears next to the “Free” Space Listing. The option choices include “ADD, IMPORT or MOUNT”. When any one three choices are selected, a new window will appear explaining the functioning, any possible limitations and “OK”

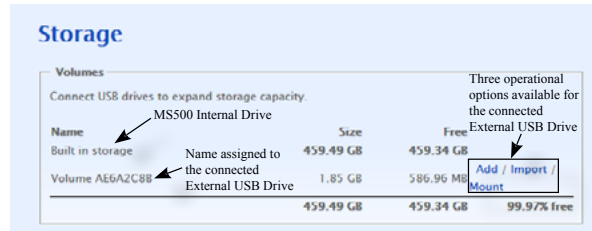

Figure 37

to activate the chosen choice. Refer to figures 38, 39 and 40

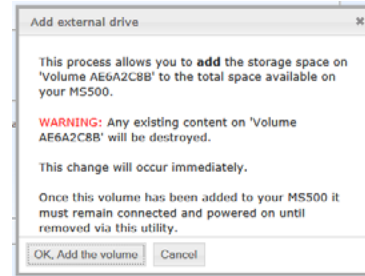

Figure 38

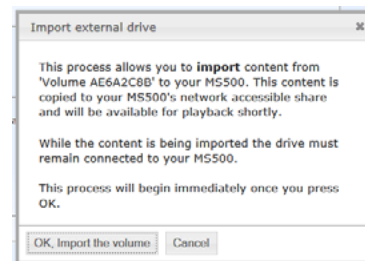

Figure 39

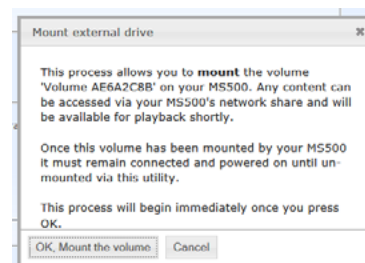

Figure 40

ADD External Storage Space to the MS500

With an External USB Drive connected to one of the MS500 Rear Panel USB Connectors, the “ADD” option will become available.

Note: Do not remove the external drive after the “ADD” option is activated.

- Start the ADD process by clicking on the button “OK, Add the volume”. Refer to figure 38 and then figure 41.

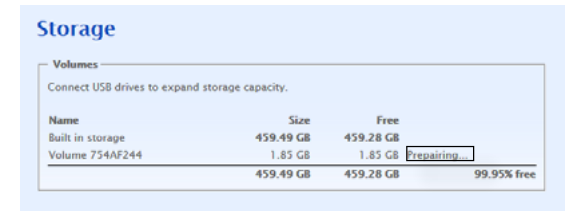

Figure 41

- When the external drive is to be removed from the MS500, select “Remove from server” and then start the remove process by clicking on the button “OK, Remove the volume”. Refer to figures 42 and 43.

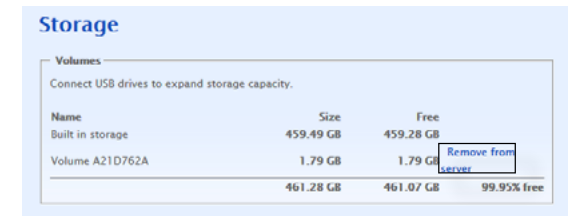

Figure 42

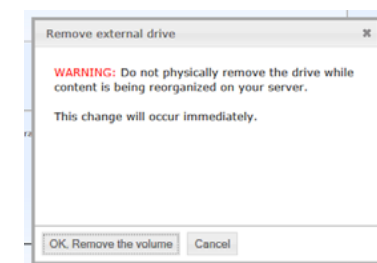

Figure 43

IMPORT Music to the MS500

With an External USB Drive connected to one of the MS500 Rear Panel USB Connectors, the “IMPORT” option will become available.

1. Start the Import process by clicking on the button “OK, Import the volume” (Figure 39). During the “Import” functioning, various messages will appear in the window indication the “Importing status”. Refer to figure 41, 42 and 43.

Note: After an external drive is connected to the MS500 and the “ADD” option is activated it can not be disconnected until after the import process copies all of the music files it finds on the externally connected storage drive. Depending on the amount of music files on the drive, the copying process could take some time.

2. Start the import process by clicking on the button “OK, Import the volume”. Refer to figures 44 and 45.

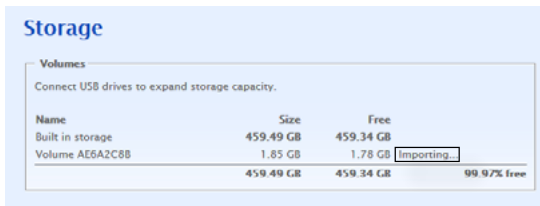

Figure 44

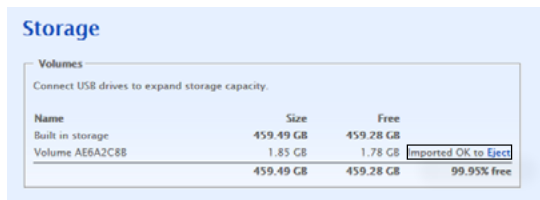

Figure 45

3. Then select local music, click on albums, and select the music just Imported into the MS500.

MOUNT External Storage Drive to the MS500

With an External USB Drive connected to one of the MS500 Rear Panel USB Connectors the “MOUNT” option will become available.

1. Start the Mount process by clicking on the button “OK, Mount the volume” (Figure 40). During the “Mount” functioning, various messages will appear in the window indication the “Mount status”. Refer to figure 46.

Note: Do not remove the external drive after the “Mount” option is activated.

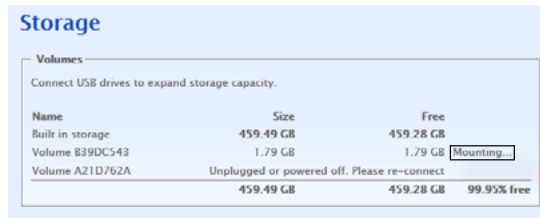

Figure 46

2. If when the external drive is to be removed from the MS500, select “Unmount”. Refer to figure 47.

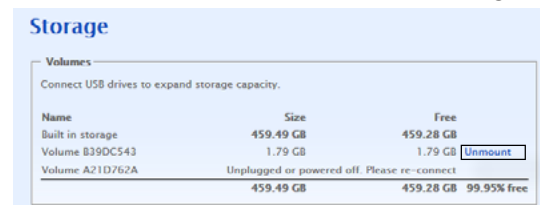

Figure 47





How to Operate the MS500, con't

Using the McIntosh Media Sync Program

The McIntosh Media Sync Computer Program allows you to select music that is stored on your computer(s) and other components that are also connected to the same computer network as the McIntosh MS500 Music Streamer. The program will automatically copy the selected music onto the MS500. After the music is copied on to the MS500, it will also automatically remove it from the computer(s) and the other components on the computer network. Perform the following steps to install the McIntosh Media Sync for Windows:

Notes: 1. If your computer is an Apple Mac unit, the McIntosh Media Sync for Mac can be installed instead.

2. The McIntosh Media Sync Program is designed to work on a Home Computer Network System.

1. Using your computer connected to the same network as the MS500, launch an Internet Web Browser Application (such as Windows Internet Explorer). Type in on the “URL-Address line” the following:

The IP Address Number

HTTP://_____/config

2. Then press enter on the computer keyboard. Refer to figure 48 (partial view).



Figure 48 (partial view)

3. Click on the “Content” Tab (located along the top), then scroll down to “Media Synchronization”. Referring to figure 49,



Figure 49

4. Select “Install McIntosh Media Sync for Windows”.
5. A small window appears at the bottom of the screen, then click on the “Run” button to start the installation of the MediaSyncSetup.exe Program. Refer to figures 49 thru 55.
6. When figure 55 appears on the screen, click on the “Finish” button to start the just installed McIntosh Media Sync Program.

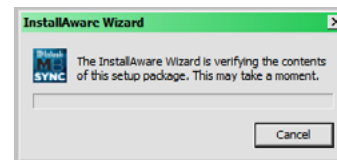

Figure 50

Note: To start the McIntosh Media Sync Program, select hidden icons and click on the icon. Refer to figure 56.

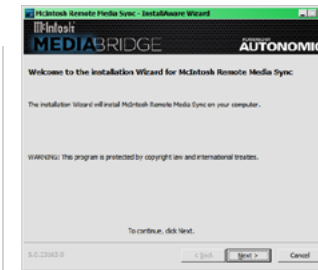

Figure 51

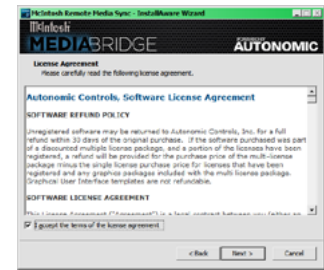

Figure 52

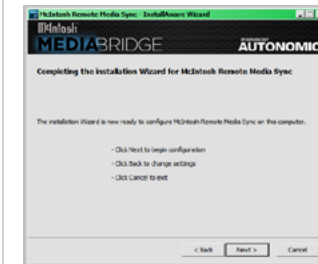

Figure 53

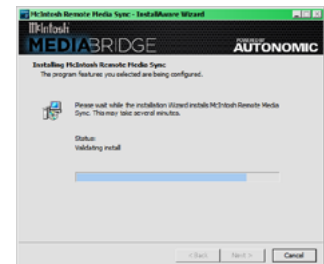

Figure 54

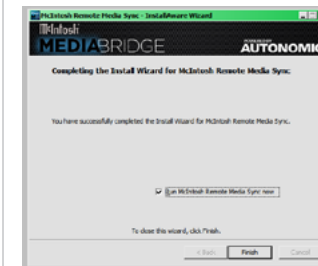

Figure 55

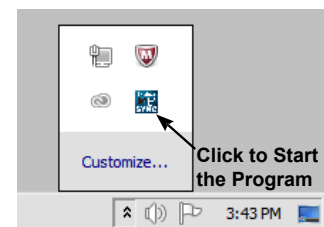

Figure 56

Once the McIntosh Media Sync Program is installed on the computer and has been started, there are some additional functions that need to be completed for actual operational functioning for your computer network system that the MS500 is connected to. Perform the following steps:

7. Currently on the Computer Screen the STATUS Tab should be displayed. Refer to figure 57.
8. In the top pull down window, the display should

be indicating “MediaBridge1 -Media Control Server on MediaBridge 1 (IP address). The IP Address is the current MS500 IP Address as displayed in the upper left corner on TV/Monitor the MS500 is connected to.

9. If the Server IP Address needs to be changed, select the top pull down window ▼ and then select the “Add Server”. Refer to figure 58.

10. Add in the new IP Address in the “Add Server” window and then click on “Add Server”. Refer to figure 59.

11. After the IP Address settings have been completed, click on the “iTunes” Tab for the iTunes Music Settings. Refer to figure 60.

Note: If there is no iTunes Library Music on your computer the “iTunes Tab” will be replaced by a grayed out

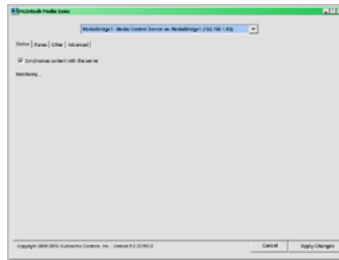

Figure 57

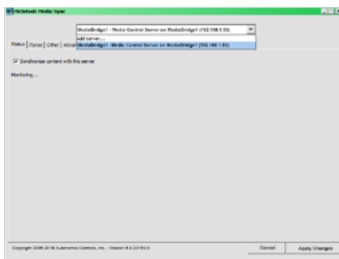

Figure 58

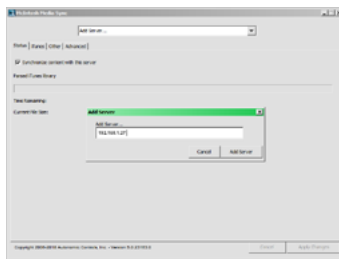

Figure 59

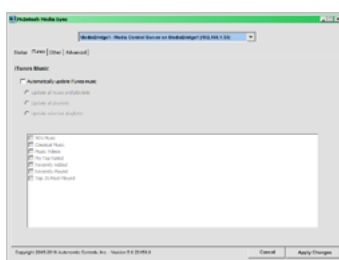

Figure 60

“iTunes (Missing Library)” Tab.
12. After selecting the “iTunes Tab”, click on the “Automatically update iTunes music” and the “Update all Music and Playlists”. Then select the desired “Playlists” and the Music Category(s) appearing in the white window. Refer to figure 61.

Note: To prevent deleting Music unintentionally, please ensure iTunes is sharing this Library.

13. Referring to figures 62 and 63, select the “OTHER Tab” to add other (non-iTunes) music on the computer (or from other components connected to the same Network as the MS500). To add Folders that contain Music, click the “+” button and then select the desired Folder containing the music you want the MS500 to be able

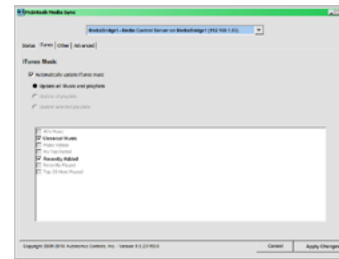

Figure 61

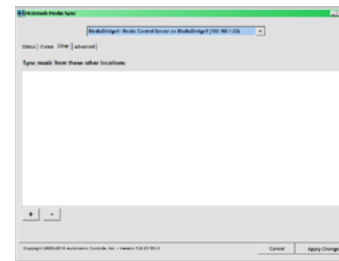

Figure 62

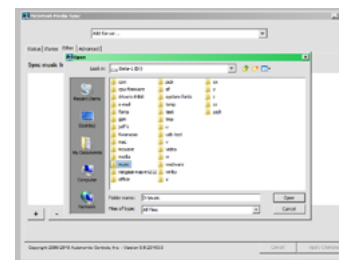

Figure 63

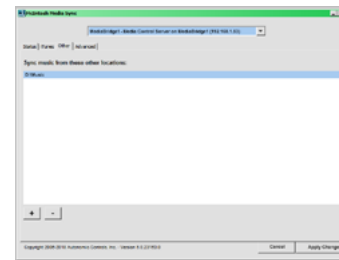

Figure 64

to playback. To add more folders repeat the same procedure. When all the folders have been selected, click on the “Apply Changes” button to start the process of copying the selected music track onto the MS500. Refer to figure 64.

14. Referring to figure 65, select the “Advanced Tab” which has “Server Information”, “Advanced Server Functions” and “Options”.

By default the McIntosh Media Sync Computer Program starts up every time the computer it is installed on is switched On and the program operates in the background. It automatically maintains synchronization of the music tracks on the MS500 that were copied from the computer(s) and the other components on the network that the MS500 is connected to.

If you do not want the McIntosh Media Sync Computer Program to automatically maintain synchronization of the music tracks, uncheck the “OPTIONS: Start at login”. This prevents the copying and/or deleting music tracks on the MS500 that are or were from the computer and the other components on the computer network. You can then perform the copying and/or deleting music tracks on the MS500 by manually starting the McIntosh Media Sync Computer Program. Refer to figure 56.

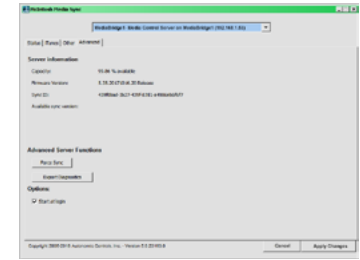

Figure 65







Audio Specifications

Fixed Output Level

2.0Vrms Unbalanced
4.0Vrms Balanced

Output Impedance

600 ohms Unbalanced and Balanced

Signal to Noise Ratio

102dB (IHF A-Weighted)

Dynamic Range

96dB

Harmonic Distortion

0.005%

Channel Separation

95dB (1,000Hz)

Digital Audio Specifications

Digital Output

Coaxial: 0.5V p-p/75 ohms
Optical: - 15dbm to -21dbm (TOS Link)

Digital Output Format

SPDIF (PCM¹)

Digital Output Sample Rate

Up to 24-Bit/192kHz

¹ PCM (Pulse Code Modulation) Digital Signal Type

Video Specifications

Signal System

Digital Video

Signal Format

HDMI and VGA

Screen Resolution

720p or 1080p

Power Control Specifications

Power Control Input

5-15VDC, less than 1mA

Power Control Output

12VDC, 25mA maximum total

General Specifications

Power Requirements

Field AC Voltage conversion of the MS500 is not possible. The MS500 is factory configured for following AC Voltages:
100-240 Volts, 50/60Hz at 2.0 Amps
Standby: Less than 0.5 watt

Overall Dimensions

Width is 17-1/2 inches (44.4cm)
Height is 3-7/8 inches (9.8cm)
Depth is 16 inches (40.6cm) including the Front Panel and connection cables.

Weight

13.5 pounds (6.1Kg) net (includes the external Power Supply), 28 pounds (12.7Kg) in shipping carton

Shipping Carton Dimensions

Width is 26-1/2 inches (67.3cm)
Height is 11-3/4 inches (29.9cm)
Depth is 24-1/4 inches (62.2cm)

Packing Instructions

In the event it is necessary to repack the equipment for shipment, the equipment must be packed exactly as shown below. It is very important that the four plastic feet are attached to the bottom of the equipment. This will ensure the proper equipment location on the bottom pad. Failure to do this will result in shipping damage.

Use the original shipping carton and interior parts only if they are all in good serviceable condition. If a shipping carton or any of the interior part(s) are needed, please call or write Customer Service Department of McIntosh Laboratory. Refer to page 4. Please see the Part List for the correct part numbers.

Quantity	Part Number	Description
1	033838	Shipping carton only
4	033837	End cap
1	033836	Inside carton only
1	033725	Top pad
1	034576	Bottom pad
1	034547	Bottom filler pad
2	034446	Foam plug
4	017937	Plastic foot
4	400159	#10-32 x 3/4" screw
4	404080	#10 Flat washer

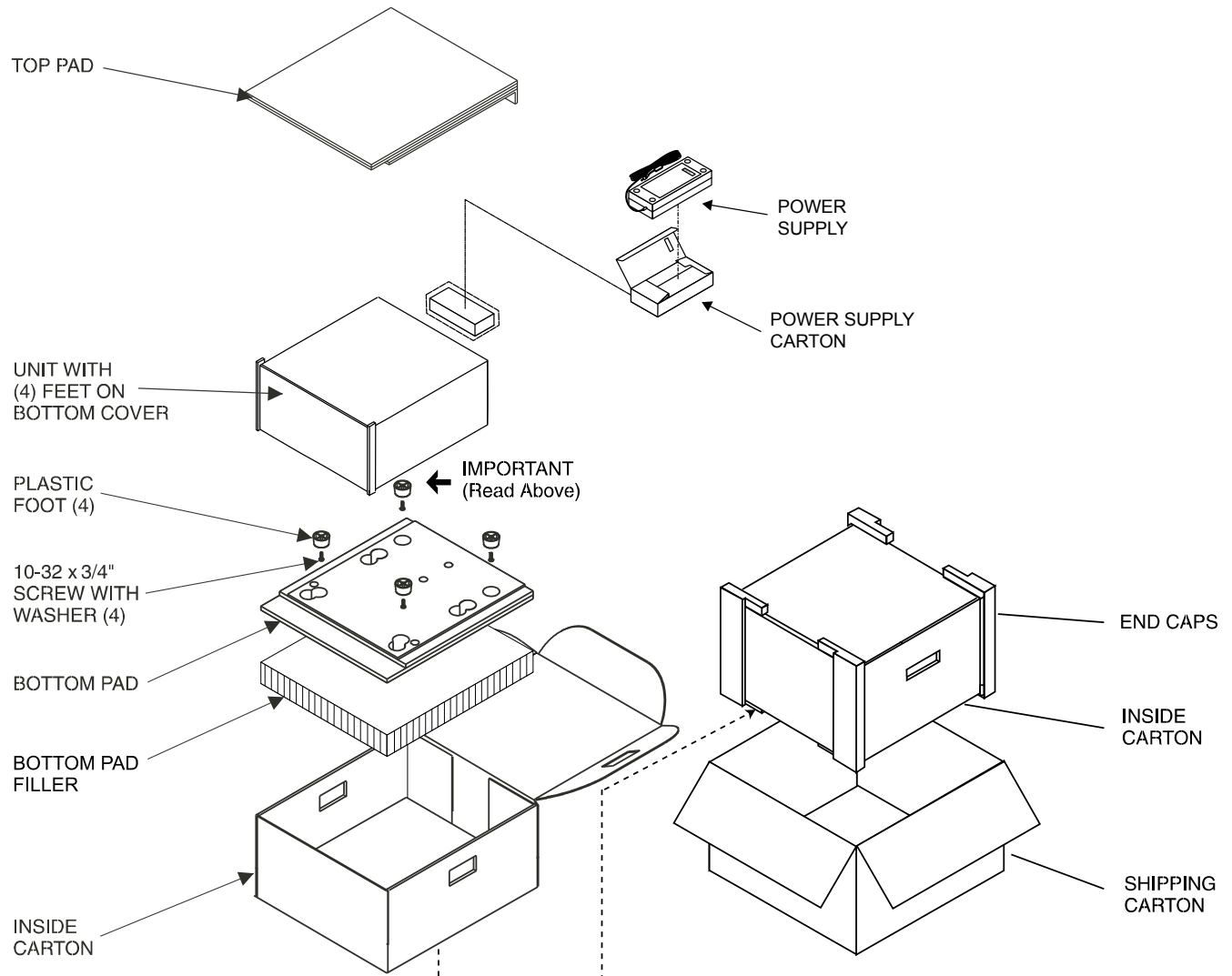



McIntosh Laboratory, Inc.
2 Chambers Street
Binghamton, NY 13903
www.mcintoshlabs.com

The continuous improvement of its products is the policy of McIntosh Laboratory Incorporated who reserve the right to improve design without notice. Printed in the U.S.A.

The MS500 is designed to employ non-McIntosh-provided services (including but not limited to Spotify, Tidal, Pandora, SiriusXM and Napster), some of which require separate customer subscriptions and some of which do not, as part of the Products' functionality. Because McIntosh cannot control the providers of such services or the services themselves, the owner of the Product therefore assumes all risks related to the use of services provided by anyone other than McIntosh itself. McIntosh cannot and does not warrant against, and shall have no liability of any kind for any of the following that are attributable to non-McIntosh providers or services: (i) interruption, discontinuance, or other unsatisfactory performance of service; (ii) reduced Product functionality that is so attributable; or (iii) any other loss or damage of any kind that is so attributable.