

## *H190 User Manual*







Congratulations, on your new Hegel H190. All Hegel products are based on a simple philosophy: Add as little as possible. Keep the music signal as close to the original as possible. We always chase lower distortion and lower noise. The music is reproduced as close to the original as possible and is limited only by the quality of the recording. Our aim is to give you the best possible music experience. Our minimalistic Scandinavian design is styled to fit in with any interior. The products shall be easy to operate and manufactured according to the best quality principles.

“Hegel H190 replaces the Hegel H160, one of our all time best sellers, and the first EISA Award winning product from Hegel. The new H190 has newer features, updated design and sounds much better. The new soundengine gives it better woofer control with a damping factor of more than 4000. A bigger soundstage, more details, clearer sound and the ability to play loud longer, on bigger speakers than the H160 could. Hope you enjoy it as much as we do.”

A handwritten signature in black ink, appearing to read 'Bent Holter', with a long, sweeping underline that extends to the right.

Bent Holter  
Founder Hegel Music System



## Index

|                        |    |
|------------------------|----|
| A word from Bent       | 3  |
| What's in the box      | 6  |
| Quickstart             | 7  |
| General Use            | 11 |
| Connections            | 12 |
| Network Configuration  | 13 |
| Using AirPlay          | 14 |
| Using Spotify          | 15 |
| Remote Control         | 16 |
| Special Functions      | 17 |
| General Information    | 18 |
| Additional Information | 19 |

## What's in the box

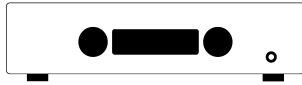

Amplifier

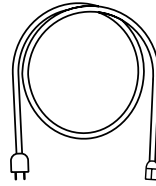

Power Cord

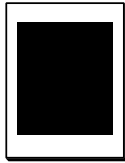

Accessory Box

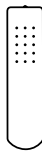

Remote Control

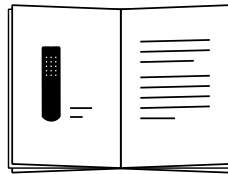

User Manual

# Quickstart

## 1. Connect your speakers

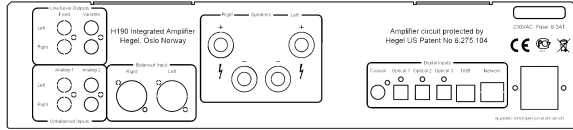

For the best audio experience the distance between the listener and each speaker should be the same.

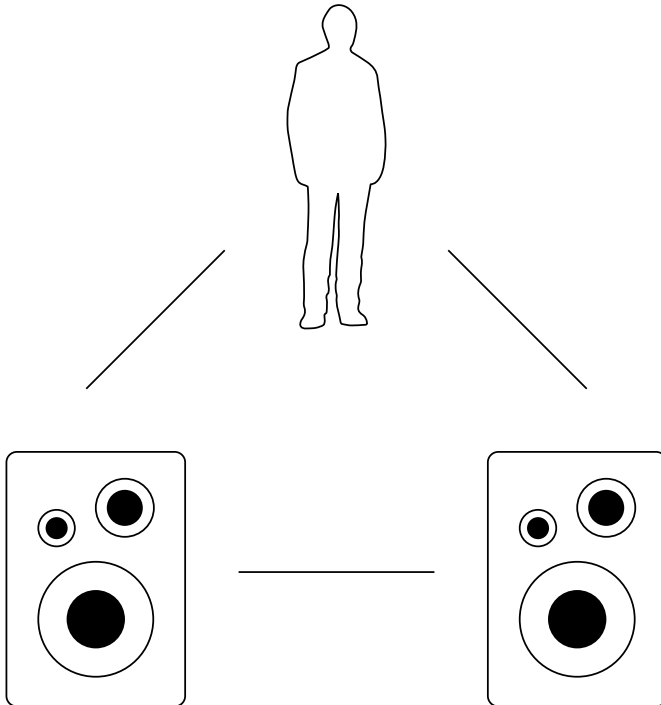

# Quickstart

## 2. Connect a source

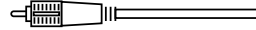
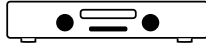

Unbalanced Analog

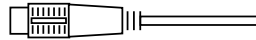
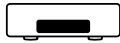

Balanced Analog

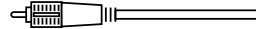
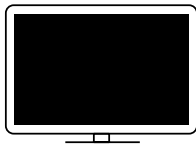

Coaxial Digital

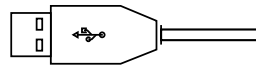

USB Computer

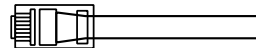
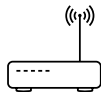

Network streaming

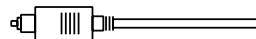

Optical Digital



## Quickstart

### 3. Connect the power cord

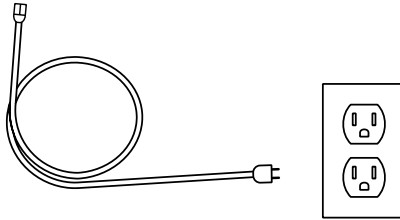
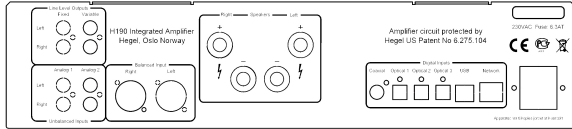

### 4. Turn on the amplifier

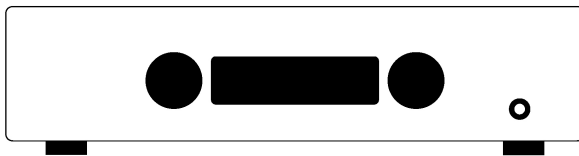

Power Switch



## General Use

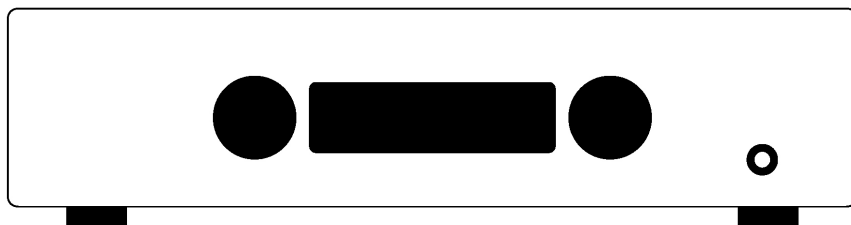

### On/Off

The H190 amplifier is switched on and off with the power button, located on the underside of the amplifier, towards the front of the unit. When powered up, the H190 takes a few seconds to calibrate. During this time, the outputs are muted.

**NOTE:** When powered up, the outputs are muted and the right hand part of the display flashes for a few seconds, indicating mute. This is normal, and is part of the start-up procedure.

**NOTE:** When the H190 has been switched off, wait 30 seconds before powering on again.

### Display

The left side of the display shows the selected source input, while the volume value is shown on the right side of the display. A flashing volume value indicates the amplifier is in mute mode.

### Headphone Output

Connect the 6.3mm headphone jack to the front of the H190. This activates the headphone volume control and mutes the speaker outputs.

**NOTE:** Variable Line Output is still active.

### Source Selector

The input source selector knob is on the left side of the front panel.

### Volume

The volume control knob is on the right side of the front panel. The volume level is indicated by a number between 0 and 99 on the right side of the display, with 0 being the mute level and 99 being max volume. The H190 powers up with a preset volume value. The volume level is adjusted by turning the volume knob clockwise or counter clockwise, or by using the Hegel remote control.

### Mute

Pressing the mute button on the Hegel remote control mutes the outputs on the amplifier. The volume number flashes to indicate that mute is on. Press the mute button, or adjust the volume level, to switch mute off.

### Status Indicators

The Hegel H190 will display the product status

✓ If it is connected to a network

✗ If there is a network problem

# Connections

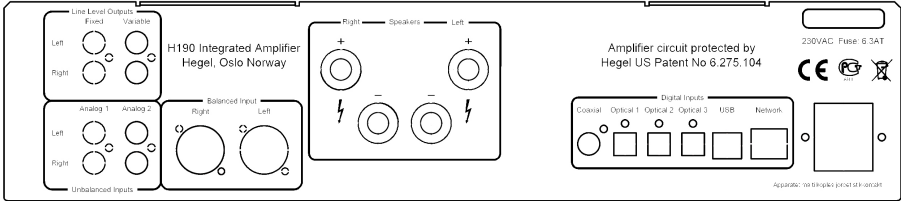

Always power the amplifier off before connecting input/output audio cables and the power cable.

## Line Level Outputs

- Fixed Line level (RCA)  
WARNING High level output.
- Variable Line Level (RCA)

## Analog Inputs

- An1(RCA): Standard analog input
- An2(RCA): Standard analog input
- Balanced (XLR): Standard balanced analog input (Pin 1 is Chassis Ground; Pin 2 is Positive Phase; Pin 3 is Negative Phase)

If you want to connect Röst to a Home Theater, see page 16

## Speakers

- Right outputs
- Left outputs

## Digital Connections

- Coax1: Input Coaxial/RCA
- Optical1: Input TOSLINK/EIAJ Optical
- Optical2: Input TOSLINK/EIAJ Optical
- Optical3: Input TOSLINK/EIAJ Optical
- Computer USB input
- Home network connection (LAN - RJ45)

## AC Power Connection

- AC Power connector with fuse holder: 230V/115V/100V AC depending on country.

## Network Configuration

Use the Network Configuration page to change the name, the IP settings and update the firmware.

PC: Open the Network Settings, under Media devices the Hegel H190 will appear. If the Hegel H190 does not appear, make sure the network is setup to hand out IP addresses automatically. When you click on the Hegel H190, the Network Configuration page opens.

MAC: Open the Safari browser. Under bookmarks, you will find the Bonjour tab, and here the Hegel H190 will appear.

If you can't find the Bonjour tab, select on (Preferences -> Advanced -> Bonjour) in the Bookmarks Menu.

### Playing Files on a Network Device

The Hegel H190 can function as a DLNA Digital Media Renderer. This means that it can receive and play media files from a UPnP/DLNA compatible media player.

For details on how to set up your media player, please refer to the user manual supplied with the player.

The Hegel H190 supports the following formats from a UPnP/DLNA compatible player: PCM (WAV), FLAC, ALAC, Ogg and MP3.

For more tips and tricks about how to use the H190 with a NAS drive, DLNA players and other software solutions, go to [www.hegel.com/products/integrated/H190](http://www.hegel.com/products/integrated/H190)

## Using AirPlay

When using AirPlay on the Hegel H190, you can send the music stream from your AirPlay compatible device, to the amplifier. Start with connecting your Hegel H190 to your local network using Ethernet cable from network connection (LAN - RJ45) on the back of the amplifier, to your router.

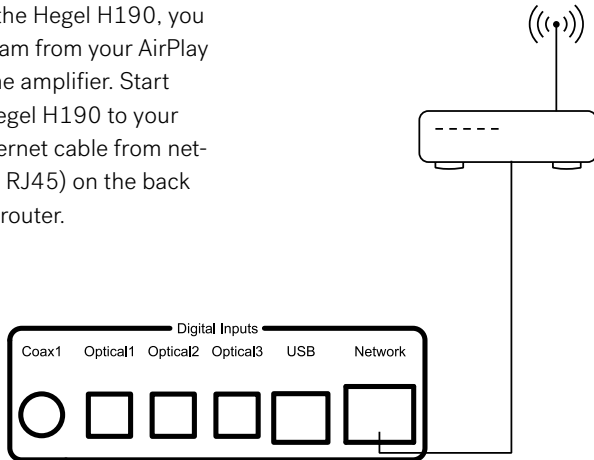

Make sure the Hegel H190 is connected to your local network.

When connected, the unit will set up to DHCP, and will automatically receive an IP-address and then integrate in your home network. All AirPlay compatible devices will now detect the Hegel H190 in their list of AirPlay speakers, it will be displayed as "H190", followed by a unique number.

To activate the AirPlay function on your AirPlay compatible device, you must first make sure the device is connected to the same network as the Hegel H190. For details on this please check the device manual. Then the AirPlay icon will be displayed and you can select the H190. You are now ready to send the music stream to your amplifier.

Playing from iTunes on your Hegel H190. Install iTunes 11, or later, on your Mac or Windows computer. Launch iTunes, press the AirPlay Logo, and select the H190. You can also play to more than one speaker at a time, select the AirPlay logo, then "multiple" and check of the speakers that you want to listen to. You can also adjust the volume on each individual speaker.

[WARNING: After selecting the H190 as the output, always remember to check the iTunes volume-setting before pressing play. The H190 will change its volume to the volume set in iTunes, when iTunes starts playing to the H190.](#)



## Remote Control - RC8

The Hegel H190 can be controlled with the included Hegel RC8 Remote Control. The RC8 controls other Hegel products, such as amplifiers and preamplifiers, and most Media players on your Mac/PC, avoiding the need for multiple remote control device

The remote control uses two standard 1.5-volt LR03 AAA batteries. To insert the batteries, use a crosshead (Phillips) screwdriver to gently remove the four screws on the underside of the remote control.

Insert the batteries with the correct polarity with + sign and - sign, as shown inside the battery holder. Be careful when inserting the batteries to not damage the battery holder. Replace the cover. Insert the screws by gently turning them by hand, to avoid damaging

the threads in the remote control chassis.

Do not tighten the screws too much, as this can damage the screws and the soft metal chassis of the remote control.

Caution: Do not drop the remote control on the floor, as this can damage its internal parts and the battery holder.

To avoid damage to the remote control by leakage from the batteries during transport and storage, the remote control is supplied without batteries from Hegel.

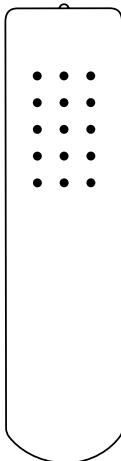

### Remote control buttons (starting top left)

1. Skip to previous track on most computers/media players
2. Play/Pause on most computers/media players
3. Skip to next track on most computers/media players
4. Input source selector button for Hegel DACs
5. ECO will put certain Hegel equipment in low power mode
6. Display on/off (hold for off)
7. Skip to previous track on Hegel CD-players
8. Play/Pause for Hegel CD-players
9. Skip to next track on Hegel CD-players
10. Switches up to next input on your Hegel amplifier
11. Stop/Eject for Hegel CD-players
12. Volume up for Hegel amplifiers
13. Switches down to previous input on your Hegel amplifier
14. Mute for Hegel amplifiers
15. Volume down for Hegel amplifiers



## Special Functions

### Display On/Off

The DISP button on the RC8 remote control may be used to turn the display of the H190 on or off. Hold the DISP button for more than 1 second to turn the display off. Press the button turn the display on.

### Home Theater or Standard Analog Input

All inputs can be changed into a Home Theater input. This will set the Volume at a fixed high volume level. Use the RC8 remote to change the settings. Hold computer play until the setup menu appears. Use computer prev/next to navigate to "HT" and press computer play to select this submenu. Now use computer next/prev to maneuver to the input you want to change into a fixed level input. Press computer Play to toggle between a fixed level input or normal variable input. Now don't press anything for 15sec, and the H190 will return to normal mode.

[WARNING: Activating Home Theater sets the volume at a high fixed level. This may harm your speakers if a fixed level input is connected.](#)

### Set Power Up Volume

A user defined volume value may be used as the power-up volume. The current volume is set as the power-up volume by pressing and holding the DAC+ button while pressing Vol- on the RC8 remote control.

### Reset to Factory Default Settings

By pressing and holding the DAC+ button while pressing Mute on the RC8, the H190 will be reset to factory settings. This will clear all user defined settings, including IP settings, and reinitialize the H190.

### Max Volume

A user defined volume value may be used as the max volume.

The current volume is set as the max volume by pressing and holding the DAC+ button while pressing Vol+ on the RC8 remote control. To reset, put to max volume, press and holding the DAC+ button while pressing Vol+ on the RC8 remote control.

### Using the USB Connection:

When you connect H190 to a computer with a USB cable (not included), the H190 will automatically install itself as a USB soundcard on all newer versions of Windows and MAC OS X, and most newer versions of Linux.

When your computer is connected with the USB-cable you may use the supplied remote control to skip/play/pause in most media players.

The first time you connect your computer to H190: Connect the computer to the internet and close all media players, such as iTunes or Windows Media Player.

### Troubleshooting with MAC:

H190 connected but no sound out of the speakers: Go to System Preferences – Sound – Output and select "TE7022 Audio w/ SPDIF" as the Output Device.

### 24 bit Audio:

H190 can receive 24-bit music files through the USB interface. Sending 24-bit audio signals, from your computer, may require some set-up in your media player. Setup varies depending on the operating system and the media player. Consult the FAQ section of the media player for details.

CD-quality and lower resolution files:  
No additional set-up is needed.

# General Information

## Transport and Shipment

If you are packing the amplifier for shipping, please follow these instructions to avoid damaging the unit:

Be careful not to hold the volume- and source-knobs when lifting the amplifier.

Put the plastic bag around the amplifier. Make sure that the plastic bag does not press tightly on the knobs as this may damage them during transportation.

Make sure the bottom shock absorber is placed at the bottom of the original cardboard box.

Place the amplifier into the shock absorber. Place the top shock absorber on top of the amplifier.

Make sure the plastic bag is still loose around the volume and source knobs to avoid any damage to the knobs during transport. Close the cardboard box using a suitable tape.

## Cleaning

Fingerprints or stains on the front panel or top cover can be removed with a cloth moistened with warm water or a mild detergent suitable for cleaning mirrors and windows.

## Technical Specifications

### H190 Integrated Amplifier

|                       |  |
|-----------------------|--|
| Power output          | 2*150W in 8 ohms<br>2*250W in 4 ohms,  |
| Minimum load          | 2 ohms   |
| Analog Inputs         | 1*balanced (XLR),<br>2*unbalanced (RCA),   |
| Digital Inputs        | 1*coaxial S/PDIF,<br>3*optical S/PDIF,<br>1*USB,<br>1*Network  |
| Line level Output     | 1*unbalanced fixed(RCA),<br>1*unbalanced variable(RCA)   |
| Frequency response    | 5Hz-100kHz   |
| Signal-to-noise ratio | More than 100dB  |
| Crosstalk             | Less than -100dB   |
| Distortion            | Less than 0.01% @<br>50W 8 Ohms 1kHz   |
| Intermodulation       | Less than 0.01%<br>(19kHz + 20kHz)   |
| Damping factor        | More than 4000<br>(main power output stage)  |
| Dimensions            | 12cm x 43cm x 41cm<br>(HxWxD),<br>19kg shipment weight.<br>7,72" x 16,93" x 16,15"<br>(HxWxD),<br>41,89 lbs shipment weight. |

## Additional Information

### Warning

Hegel products should only be opened or serviced by certified technicians. The devices contain electronic components that may cause severe electric shock. Work performed on Hegel products by unqualified personnel may cause serious damage or personal injury.

Opening of the product by non-authorized personnel will void the guarantee.

The products must not be exposed to rain or moisture.

### Warranty

All Hegel products come with a 2-year warranty against defective materials and workmanship.

In case you would need any assistance with your Hegel product please find your nearest dealer or distributor by looking at the Hegel web site <http://www.hegel.com>. If you experience any problems locating your dealer or distributor please contact [info@hegel.com](mailto:info@hegel.com)

### More Information

For more information, please visit [www.hegel.com/products/integrated/H190](http://www.hegel.com/products/integrated/H190)

### Use and Placement

The HEGEL H190 should be placed on a flat, hard surface for proper cooling. The amplifier performs best after being switched on for about 1 hour for heating up. A certain space is required for air circulation above and below the amplifier. The amplifier must never be placed on a carpet or similar surface that obstructs air circulation through the unit. Nor must it be covered while in use or placed on a narrow shelf or in another confined space.

The amplifier will automatically switch itself off if overheated.

Never lift the H190 by holding around the volume knob or input selector knob. The H190 is heavy, and applying pressure may damage the knobs.



AirPlay works with iPhone, iPad and iPod touch with iOS 4.3.3 or later, Mac with OS X Mountain Lion or later, and PC with iTunes 10.2.2 or later.

"Made for iPod," "Made for iPhone," and "Made for iPad" mean that an electronic accessory has been designed to connect specifically to iPod, iPhone, or iPad, respectively, and has been certified by the developer to meet Apple performance standards. Apple is not responsible for the operation of this device or its compliance with safety and regulatory standards. Please note that the use of this accessory with iPod, iPhone, or iPad may affect wireless performance.

AirPlay, iPad, iPhone, iPod and iPod touch are trademarks of Apple Inc., registered in the U.S. and other countries. In Japan, the trademark "iPhone" is used with a license from Aiphone K.K.



